

Interchangeable Lens Digital Camera

α6300

E-mount

Instruction Manual



“Help Guide” (Web manual)

Refer to “Help Guide” for in-depth instructions on the many functions of the camera.

http://rd1.sony.net/help/ilc/1540/h_zz/

Learning more about the camera (“Help Guide”)



“Help Guide” is an on-line manual. You can read the “Help Guide” on your computer or smartphone.

Refer to it for in-depth instructions on the many functions of the camera.

URL:

http://rd1.sony.net/help/ilc/1540/h_zz/



Viewing the Guide

This camera is equipped with a built-in instruction guide.

In-Camera Guide

The In-Camera Guide displays explanations for the currently selected menu function or setting.

- ① Assign In-Camera Guide to the desired button using [Custom Key(Shoot.)].
MENU button →  (Custom Settings) → [Custom Key(Shoot.)] → Select the desired button assigned to the function. → [In-Camera Guide]
- ② Press the MENU button and use the control wheel to select a MENU item whose explanation you want to read, and then press the button to which [In-Camera Guide] is assigned.

Owner's Record

Record the model and serial number (which are located on the product) in the space provided below. Refer to these numbers whenever you call your Sony dealer regarding this product.

Model No. ILCE-

Serial No. _____

WARNING

To reduce fire or shock hazard, do not expose the unit to rain or moisture.

IMPORTANT SAFETY INSTRUCTIONS -SAVE THESE INSTRUCTIONS DANGER TO REDUCE THE RISK OF FIRE OR ELECTRIC SHOCK, CAREFULLY FOLLOW THESE INSTRUCTIONS

If the shape of the plug does not fit the power outlet, use an attachment plug adaptor of the proper configuration for the power outlet.

CAUTION

Battery pack

If the battery pack is mishandled, the battery pack can burst, cause a fire or even chemical burns. Observe the following cautions.

- Do not disassemble.
- Do not crush and do not expose the battery pack to any shock or force such as hammering, dropping or stepping on it.
- Do not short circuit and do not allow metal objects to come into contact with the battery terminals.
- Do not expose to high temperature above 60°C (140°F) such as in direct sunlight or in a car parked in the sun.
- Do not incinerate or dispose of in fire.
- Do not handle damaged or leaking lithium ion batteries.
- Be sure to charge the battery pack using a genuine Sony battery charger or a device that can charge the battery pack.
- Keep the battery pack out of the reach of small children.
- Keep the battery pack dry.
- Replace only with the same or equivalent type recommended by Sony.
- Dispose of used battery packs promptly as described in the instructions.

Use a nearby wall outlet (wall socket) when using the supplied or recommended AC Adaptor/battery charger. If any malfunction occurs while using this product, disconnect the plug from the wall outlet (wall socket) immediately to disconnect from the power source. If you use the product with a charge lamp, note that the product is not disconnected from the power source even when the lamp turns off.

The power cord (mains lead), if supplied, is designed specifically for use with this equipment only, and should not be used with other electrical equipment.

Power Cord

For the customers in the UK, Ireland, Malta, Cyprus and Saudi Arabia Use the power cord (A). For safety reasons, the power cord (B) is not intended for above countries/regions and shall therefore not be used there.

For the customers in other EU countries/ regions

Use the power cord (B).

(A)



(B)



For Customers in the U.S.A. and Canada

RECYCLING LITHIUM-ION BATTERIES

Lithium-Ion batteries are recyclable.

You can help preserve our environment by returning your used rechargeable batteries to the collection and recycling location nearest you.

For more information regarding recycling of rechargeable batteries, call toll free 1-800-822-8837, or visit <http://www.call2recycle.org/>

Caution: Do not handle damaged or leaking Lithium-Ion batteries.

For supplied accessories

This device complies with Part 15 of the FCC Rules. Operation is subject to the following two conditions:

(1) This device may not cause harmful interference, and (2) this device must accept any interference received, including interference that may cause

GB undesired operation.

4

CAN ICES-3 B/NMB-3 B



This equipment complies with FCC/IC radiation exposure limits set forth for an uncontrolled environment and meets the FCC radio frequency (RF) Exposure Guidelines and RSS-102 of the IC radio frequency (RF) Exposure rules. This equipment has very low levels of RF energy that are deemed to comply without testing of specific absorption ratio (SAR).

For Customers in the U.S.A.

If you have any questions about this product, you may call:

Sony Customer Information Center
1-800-222-SONY (7669).

The number below is for the FCC related matters only.

Regulatory Information

Declaration of Conformity

Trade Name: SONY

Model No.: WW906746

Responsible Party: Sony Electronics Inc.

Address: 16535 Via Esprillo,
San Diego, CA 92127
U.S.A.

Telephone No.: 858-942-2230

This device complies with Part 15 of the FCC Rules. Operation is subject to the following two conditions: (1) This device may not cause harmful interference, and (2) this device must accept any interference received, including interference that may cause undesired operation.

This equipment must not be co-located or operated in conjunction with any other antenna or transmitter.

CAUTION

You are cautioned that any changes or modifications not expressly approved in this manual could void your authority to operate this equipment.

Note:

This equipment has been tested and found to comply with the limits for a Class B digital device, pursuant to Part 15 of the FCC Rules.

These limits are designed to provide reasonable protection against harmful interference in a residential installation. This equipment generates, uses, and can radiate radio frequency energy and, if not installed and used in accordance with the instructions, may cause harmful interference to radio communications. However, there is no guarantee that interference will not occur in a particular installation. If this equipment does cause harmful interference to radio or television reception, which can be determined by turning the equipment off and on, the user is encouraged to try to correct the interference by one or more of the following measures:

- Reorient or relocate the receiving antenna.
- Increase the separation between the equipment and receiver.
- Connect the equipment into an outlet on a circuit different from that to which the receiver is connected.
- Consult the dealer or an experienced radio/TV technician for help.

The supplied interface cable must be used with the equipment in order to comply with the limits for a digital device pursuant to Subpart B of Part 15 of FCC Rules.

For Customers in Canada

This device complies with Industry Canada's licence-exempt RSSs. Operation is subject to the following two conditions:

- (1) This device may not cause interference; and
- (2) This device must accept any interference, including interference that may cause undesired operation of the device.

For Customers in Europe

Notice for the customers in the countries applying EU Directives

Manufacturer: Sony Corporation, 1-7-1 Konan Minato-ku Tokyo, 108-0075 Japan
For EU product compliance: Sony Belgium, bijkantoor van Sony Europe Limited, Da Vincilaan 7-D1, 1935 Zaventem, Belgium



Hereby, Sony Corporation, declares that this equipment is in compliance with the essential requirements and other relevant provisions of Directive 1999/5/EC. For details, please access the following URL: <http://www.compliance.sony.de/>

Notice

If static electricity or electromagnetism causes data transfer to discontinue midway (fail), restart the application or disconnect and connect the communication cable (USB, etc.) again.

This product has been tested and found compliant with the limits set out in the EMC regulation for using connection cables shorter than 3 meters (9.8 feet).

The electromagnetic fields at the specific frequencies may influence the picture and sound of this unit.

Disposal of waste batteries and electrical and electronic equipment (applicable in the European Union and other European countries with separate collection systems)



This symbol on the product, the battery or on the packaging indicates that the product and the battery shall not be treated as household waste. On

certain batteries this symbol might be used in combination with a chemical symbol. The chemical symbols for mercury (Hg) or lead (Pb) are added if the battery contains more than 0.0005% mercury or 0.004% lead. By ensuring these products and batteries are disposed of correctly, you will help prevent potentially negative consequences for the environment and human health which could otherwise be caused by inappropriate waste handling. The recycling of the materials will help to conserve natural resources.

In case of products that for safety, performance or data integrity reasons require a permanent connection with an incorporated battery, this battery should be replaced by qualified service staff only. To ensure that the battery and the electrical and electronic equipment will be treated properly, hand over these products at end-of-life to the applicable collection point for the recycling of electrical and electronic equipment. For all other batteries, please view the section on how to remove the battery from the product safely. Hand the battery over to the applicable collection point for the recycling of waste batteries.

For more detailed information about recycling of this product or battery, please contact your local Civic Office, your household waste disposal service or the shop where you purchased the product or battery.

For Customers in Singapore

Complies with
IDA Standards
DB00353

For Customers in U.A.E.

TRA
REGISTERED No:
ER0098751/12
DEALER No:
DA0073692/11

For Customers in Malaysia



For Customers in India

Battery Pack

IS 16046/IEC 62133



R-41022659

Table of contents

Preparing the camera Step 1 P. 8

- Checking the supplied items
- Identifying parts
- Inserting the battery pack
- Charging the battery pack
- Inserting a memory card (sold separately)
- Attaching/removing the lens
- Setting the language and the clock

Basic operation Step 2 P. 23

- Shooting still images/movies

Playback function Step 3 P. 24

- Viewing images

Recording function Step 4 P. 25

- Introduction of other functions

Using a computer P. 35

- Using software
- Importing images to your computer and using them (PlayMemories Home)

Adding functions to the camera P. 37

- Adding functions to the camera

Others P. 37

- Number of still images and recordable time of movies
- Notes on continuous movie recording
- Notes on using the camera
- Specifications

This manual covers several models supplied with different lenses.

The model name varies depending on the supplied lens. The available model varies depending on the countries/regions.

Model name	Lens
ILCE-6300	Not supplied
ILCE-6300L	E PZ 16 – 50 mm

Checking the supplied items

First check the model name of your camera (page 7). The accessories supplied differ depending on the model.

The number in parentheses indicates the quantity.

Supplied with all models

- Camera (1)
- Power cord (mains lead) (1)*
(supplied in some countries/
regions)



* Multiple power cords may be supplied with your camera. Use the appropriate one that matches your country/region. See page 4.

- Rechargeable battery pack
NP-FW50 (1)

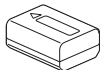

- Micro USB cable (1)

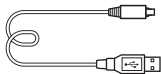

- AC Adaptor (1)

- Shoulder strap (1)

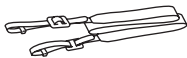

- Eyepiece cup (1)



- Shoe cap (1) (attached to the camera)
- Instruction Manual (this manual) (1)
- Wi-Fi Connection/One-touch (NFC) Guide (1)
This guide explains the functions that require a Wi-Fi connection.

ILCE-6300

- Body cap (1) (attached to the camera)

ILCE-6300L

- E PZ 16 – 50 mm zoom lens (1)
(attached to the camera)/Front lens cap (1) (attached to the lens)

Identifying parts

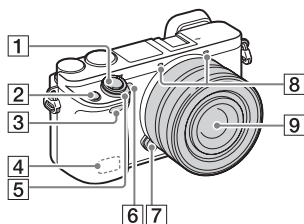



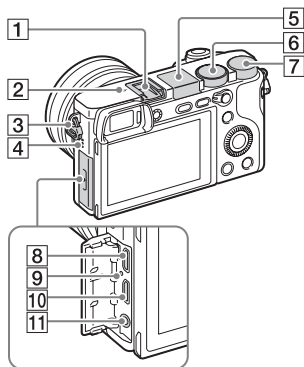
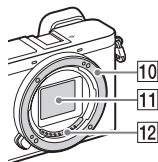

When the lens is removed



- 1 Shutter button
- 2 C1 (Custom 1) button
- 3 Remote sensor
- 4 Wi-Fi antenna (built-in)
- 5 ON/OFF (Power) switch
- 6 Self-timer lamp/AF illuminator
- 7 Lens release button
- 8 Microphone*¹
- 9 Lens
- 10 Mount
- 11 Image sensor*²
- 12 Lens contacts*²

*¹ Do not cover this part during movie recording.

*² Do not touch this part directly.

- 1 Multi interface shoe*
- 2  Image sensor position mark
- 3 Hook for shoulder strap
- 4 Speaker
- 5 Flash
 - Press the  (Flash pop-up) button to use the flash. The flash does not pop up automatically.
 - When not using the flash, press it back into the camera body.
- 6 Mode dial
 - AUTO** (Auto Mode)/
 - P** (Program Auto)/
 - A** (Aperture Priority)/
 - S** (Shutter Priority)/
 - M** (Manual Exposure)/
 - 1/2** (Memory recall)/
 -  (Movie/HFR)/
 -  (Sweep Panorama)/
 - SCN** (Scene Selection)

- 7** Control dial
- 8** Multi/Micro USB Terminal*
 - Supports Micro USB compatible device.
- 9** Charge lamp
- 10** HDMI micro jack
- 11**  (Microphone) jack
 - When an external microphone is connected, the microphone is turned on automatically. If the external microphone is a plug-in-power type, the power of the microphone is supplied by the camera.

* For details on compatible accessories for the multi interface shoe and the Multi/Micro USB Terminal, visit the Sony web site, or consult your Sony dealer or local authorized Sony service facility. You can also use accessories that are compatible with the accessory shoe. Operations with other manufacturers' accessories are not guaranteed.

mi Multi
Interface Shoe

Accessory Shoe

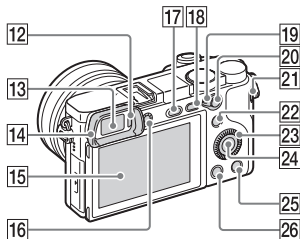

- 12** Eye sensor
- 13** Viewfinder
- 14** Eyepiece cup

- Not attached to the camera at the factory. It is recommended that you attach the eyepiece cup when you intend to use the viewfinder.

Attaching/removing the eyepiece cup

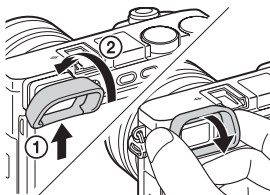

- Remove the eyepiece cup when you attach an accessory (sold separately) to the Multi Interface Shoe.

15 Monitor

- You can adjust the screen to an easily viewable angle and shoot from any position.

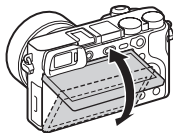

16 Diopter-adjustment dial

- Adjust the diopter-adjustment dial to your eyesight until the display appears clearly in the viewfinder. If it is difficult to turn the diopter-adjustment dial, remove the eyepiece cup and then adjust the dial.

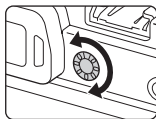

17 ⚡ (Flash pop-up) button

18 MENU button

19 AF/MF/AEL switch lever

20 For shooting: AF/MF button/
AEL button

For viewing: ⊕ (Enlarge) button

21 MOVIE (Movie) button

22 For shooting:

Fn (Function) button

For viewing:

↔ (Send to Smartphone) button

- You can display the screen for [Send to Smartphone] by pressing the ↔ (Send to Smartphone) button.

23 Control wheel

24 Center button

25 C2 (Custom 2) button/
🗑️ (Delete) button

26 ▶️ (Playback) button

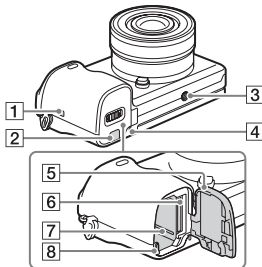

1 **N** (N Mark)

- Touch the mark when you connect the camera to a smartphone equipped with the NFC function.
- NFC (Near Field Communication) is an international standard of the short-range wireless communication technology.

2 Connection plate cover

- Use this when using an AC-PW20 AC Adaptor (sold separately). Insert the connection plate into the battery compartment, and then pass the cord through the connection plate cover as shown below.

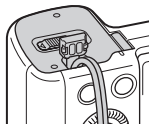

- Make sure that the cord is not pinched when you close the cover.

- 3** Tripod socket hole
- Use a tripod with a screw less than 5.5 mm (7/32 inches) long. Otherwise, you cannot firmly secure the camera, and damage to the camera may occur.
- 4** Access lamp
- 5** Battery/memory card cover
- 6** Memory card slot
- 7** Battery insertion slot
- 8** Battery lock lever

■ Lens

See page 45 on the specifications of the lenses.

E PZ 16 – 50 mm F3.5 – 5.6 OSS (supplied with ILCE-6300L)

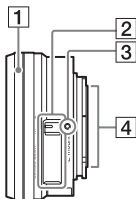

- 1** Zooming ring/Focusing ring
- 2** Zooming lever
- 3** Mounting index
- 4** Lens contacts*

* Do not touch this part directly.

Inserting the battery pack

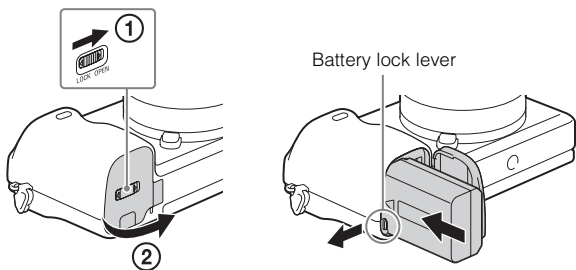

1 Open the cover.

2 Insert the battery pack.

- While pressing the battery lock lever, insert the battery pack as illustrated. Make sure that the battery lock lever locks after insertion.
- Closing the cover with the battery inserted incorrectly may damage the camera.

Charging the battery pack

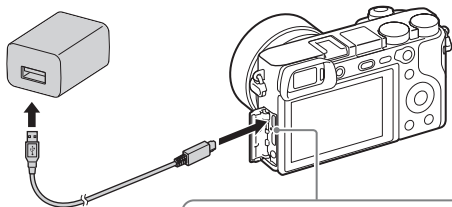

Charge lamp
Lit: Charging
Off: Charging finished
Flashing:
Charging error or charging paused temporarily because the camera is not within the proper temperature range

- 1 Connect the camera to the AC Adaptor (supplied), using the micro USB cable (supplied).
- 2 Connect the AC Adaptor to the wall outlet (wall socket). The charge lamp lights orange, and charging starts.
 - Turn off the camera while charging the battery.
 - You can charge the battery pack even when it is partially charged.
 - When the charge lamp flashes and charging is not finished, remove and re-insert the battery pack.
 - For some countries/regions, connect the power cord (mains lead) to the AC Adaptor, and connect the AC Adaptor to the wall outlet (wall socket).

Notes

- If the charge lamp on the camera flashes when the AC Adaptor is connected to the wall outlet (wall socket), this indicates that charging is temporarily stopped because the temperature is outside the recommended range. When the temperature gets back within the appropriate range, the charging resumes. We recommend charging the battery pack in an ambient temperature of between 10°C to 30°C (50°F to 86°F).

- The battery pack may not be effectively charged if the terminal section of the battery is dirty. In this case, wipe any dust off lightly using a soft cloth or a cotton swab to clean the terminal section of the battery.
- Connect the AC Adaptor (supplied) to the nearest wall outlet (wall socket). If malfunctions occur while using the AC Adaptor, disconnect the plug from the wall outlet (wall socket) immediately to disconnect from the power source.
- When charging is finished, disconnect the AC Adaptor from the wall outlet (wall socket).
- Be sure to use only genuine Sony brand battery packs, micro USB cable (supplied) and AC Adaptor (supplied).

■ Charging time (Full charge)

The charging time is approximately 150 minutes using the AC Adaptor (supplied). The charge lamp lights up and then immediately turns off when the battery pack is fully charged.

Notes

- The above charging time applies when charging a fully depleted battery pack at a temperature of 25°C (77°F). Charging may take longer depending on conditions of use and circumstances.

■ Charging by connecting to a computer

The battery pack can be charged by connecting the camera to a computer using a micro USB cable.

Notes

- If the camera is connected to a laptop computer that is not connected to a power source, the laptop battery level decreases. Do not charge for an extended period of time.
- Do not turn on/off or restart the computer, or wake the computer to resume from sleep mode when a USB connection has been established between the computer and the camera. That may cause the camera to malfunction. Before turning on/off, or restarting the computer or waking the computer from sleep mode, disconnect the camera and the computer.
- No guarantees are made for charging using a custom-built computer or a modified computer.

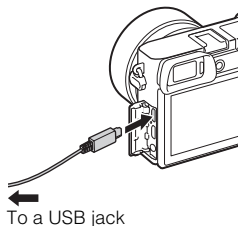

Battery life and number of images that can be recorded and played back

		Battery life	Number of images
Shooting (still images)	Monitor	—	Approx. 400 images
	Viewfinder	—	Approx. 350 images
Typical movie shooting	Monitor	Approx. 75 min.	—
	Viewfinder	Approx. 70 min.	—
Continuous movie shooting	Monitor	Approx. 115 min.	—
	Viewfinder	Approx. 115 min.	—
Viewing (still images)		Approx. 360 min.	Approx. 7100 images

Notes

- The above number of images applies when the battery pack is fully charged. The number of images may decrease depending on the conditions of use.
- The number of images that can be recorded is for shooting under the following conditions:
 - Using a Sony Memory Stick PRO Duo™ (Mark2) media (sold separately).
 - When an E PZ 16 – 50 mm F3.5 – 5.6 OSS lens is attached.
 - The battery pack is used at an ambient temperature of 25°C (77°F).
 - [Viewfinder Bright.]: [Manual] [±0]
 - [Monitor Brightness]: [Manual] [±0]
 - [Display Quality]: [Standard]
- The number for “Shooting (still images)” is based on the CIPA standard, and is for shooting under the following conditions: (CIPA: Camera & Imaging Products Association)
 - DISP is set to [Display All Info.].
 - [Focus Mode]: [Automatic AF]
 - Shooting once every 30 seconds.
 - The flash is used once every two times.
 - The power is turned on and off once every ten times.
- The number of minutes for movie shooting is based on the CIPA standard, and is for shooting under the following conditions:
 -  Record Setting: XAVC S HD 60p 50M ^{Super}_{35mm}/50p 50M ^{Super}_{35mm}.
 - Typical movie shooting: Battery life based on repeatedly starting/stopping shooting, zooming, turning on/off, etc.
 - Continuous movie shooting: Battery life based on non-stop shooting until the limit (29 minutes) has been reached, and then continued by pressing the MOVIE button again. Other functions, such as zooming, are not operated.

■ Supplying power

You can use the camera while power is supplied from a wall outlet (wall socket) by using the AC Adaptor (supplied).

Notes

- The camera will not activate if there is no remaining battery. Insert a sufficiently charged battery pack into the camera.
- If you use the camera while power is being supplied from a wall outlet (wall socket), make sure that the icon () displays on the monitor.
- Do not remove the battery pack while power is being supplied from a wall outlet (wall socket). If you remove the battery pack, the camera will turn off.
- Do not remove the battery pack while the access lamp (page 12) is lit. The data on the memory card may be damaged.
- As long as the power is on, the battery pack will not be charged even if the camera is connected to the AC Adaptor.
- Under certain usage conditions, the battery power may be consumed as a backup even when the camera is connected to the AC Adaptor while being used.
- Do not remove the micro USB cable while power is being supplied via USB connection. Before you remove the micro USB cable, turn off the camera.
- While power is being supplied via USB connection, the temperature inside the camera will rise and the continuous recording time may be shortened.
- When using a mobile charger as a power source, confirm that the mobile charger is fully charged before use. Also, be careful of the remaining power on the mobile charger during use.

Inserting a memory card (sold separately)

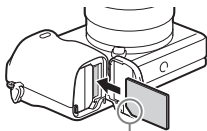
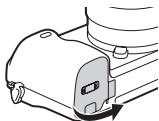

Ensure the notched corner faces correctly.

- 1 Open the cover.
- 2 Insert the memory card.
 - With the notched corner facing as illustrated, insert the memory card until it clicks into place.
- 3 Close the cover.

Memory cards that can be used

Memory card	For still images	For movies		
		MP4	AVCHD	XAVC S
Memory Stick PRO Duo	✓	✓ (Mark2 only)	✓ (Mark2 only)	—
Memory Stick PRO-HG Duo™	✓	✓	✓	✓ ^{*1}
Memory Stick Micro™ (M2)	✓	✓ (Mark2 only)	✓ (Mark2 only)	—
SD memory card	✓	✓ ^{*2}	✓ ^{*2}	—
SDHC memory card	✓	✓ ^{*2}	✓ ^{*2}	✓ ^{*3}
SDXC memory card	✓	✓ ^{*2}	✓ ^{*2}	✓ ^{*3}
microSD memory card	✓	✓ ^{*2}	✓ ^{*2}	—
microSDHC memory card	✓	✓ ^{*2}	✓ ^{*2}	✓ ^{*3}
microSDXC memory card	✓	✓ ^{*2}	✓ ^{*2}	✓ ^{*3}

^{*1} Movies cannot be recorded in 100 Mbps or more.

^{*2} SD Speed Class 4: **CLASS 4** or faster, or UHS Speed Class 1: **U1** or faster

^{*3} Memory cards that fulfill all of the following conditions:

– Capacity of 4 GB or more

– SD Speed Class 10: **CLASS 10**, or UHS Speed Class 1: **U1** or faster

When recording in 100 Mbps or more, UHS Speed Class 3: **U3** is required.

- For details on the number of recordable still images and recordable duration of movies, refer to pages 37 to 38. Check the tables to select a memory card with the desired capacity.

Notes

- When an SDHC memory card is used to record XAVC S movies over extended periods of time, the recorded movies will be divided into files of 4 GB. The divided files can be integrated into a single file using PlayMemories Home.
- Not all memory cards are guaranteed to operate correctly. For memory cards produced by manufacturers other than Sony, consult the manufacturers of the products.
- When using Memory Stick Micro media or microSD memory cards with this camera, make sure to use with the appropriate adaptor.

■ To remove the memory card/battery pack

Memory card: Push the memory card in once to eject the memory card.

Battery pack: Slide the battery lock lever. Be sure not to drop the battery pack.

Notes

- Never remove the memory card/battery pack when the access lamp (page 12) is lit. This may cause damage to data in the memory card.

Attaching/removing the lens

Set the ON/OFF (Power) switch of the camera to OFF before you attach or remove the lens.

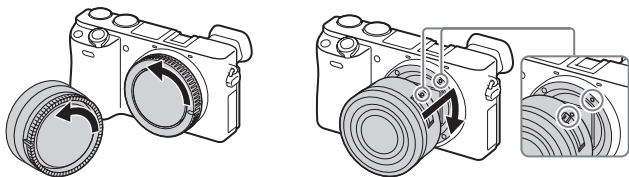

- 1** If the cap or the packaging lid is attached, remove it from the camera or the lens.
 - Change the lens quickly somewhere away from dusty locations to keep dust or debris from getting inside the camera.
- 2** Mount the lens by aligning the white index marks on the lens and the camera.
 - Hold the camera facing down to prevent dust from entering into the camera.
- 3** While pushing the lens lightly toward the camera, turn the lens clockwise until it clicks into the locked position.
 - Be sure to put the lens on straight.

Notes

- When attaching a lens, do not press the lens release button.
- Do not use excessive force when attaching a lens.
- The Mount Adaptor (sold separately) is required to use an A-mount lens (sold separately). For details, refer to the operating manual supplied with the Mount Adaptor.
- When using a lens equipped with a tripod socket, attach the socket on the lens side to the tripod to maintain balance.

■ Removing the lens

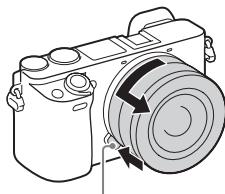

Lens release button

- 1 Press the lens release button all the way in and turn the lens counterclockwise until it stops.

Notes

- If dust or debris gets inside the camera while you are changing the lens and adheres to the surface of the image sensor (the part that converts the light source to a digital signal), it may appear as dark spots on the image, depending on the shooting environment. The camera vibrates slightly when it is turned off, due to the anti-dust function, to prevent dust from adhering to the image sensor. However, attach or remove the lens quickly somewhere away from dusty locations.
- If any foreign material has adhered to the image sensor, try [Cleaning Mode] (page 33) first and dust it off with a blower if necessary. For details, refer to the “Help Guide.”
- Do not leave the camera with the lens removed.
- When you want to use body caps or rear lens caps, please purchase ALC-BIEM (Body cap) or ALC-RIEM (Rear lens cap) (sold separately).
- When you use a lens with a power zoom, set the ON/OFF (Power) switch of the camera to OFF and confirm that the lens is completely retracted before switching lenses. If the lens has not retracted, do not press the lens in by force.
- When attaching the camera to a tripod, be sure not to touch the zooming/focusing ring by mistake.

Setting the language and the clock

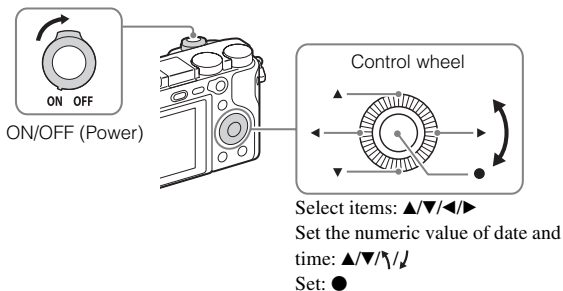

- 1** Set the ON/OFF (Power) switch to ON.
Language setting screen is displayed when you turn on the camera for the first time.
 - It may take time for the power to turn on and allow operation.
- 2** Select a desired language, then press ● on the control wheel.
Date & Time setting screen is displayed.
- 3** Check that [Enter] is selected on the screen, then press ●.
- 4** Select a desired geographic location by following the on-screen instructions, then press ●.
- 5** Set [Daylight Savings], [Date/Time] and [Date Format], then press ●.
 - When setting [Date/Time], midnight is 12:00 AM, and noon is 12:00 PM.
- 6** Check that [Enter] is selected, then press ●.

Shooting still images/movies

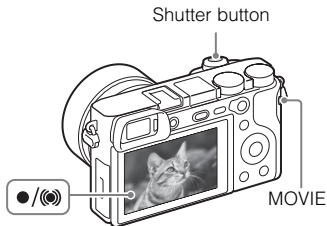

Shooting still images

- 1 Press the shutter button halfway down to focus.
When the image is in focus, the ● or (●●) indicator lights.
- 2 Press the shutter button fully down to shoot an image.

Shooting movies

- 1 Press the MOVIE (Movie) button to start recording.
 - When using a lens with a zoom lever: Move the zoom lever.
 - When using a lens with a zoom ring: Turn the zoom ring.
- 2 Press the MOVIE button again to stop recording.

Notes

- Continuous movie shooting is possible for approximately 29 minutes maximum at one time with the camera's default settings, and when the ambient temperature is approximately 25°C (77°F) (the duration of time available for movie recording varies depending on the temperature environment, the recording format/setting, or the usage conditions of the camera before you start recording (page 39)). When movie recording is finished, you can restart recording by pressing the MOVIE button again. The recording may stop in order to protect the camera depending on the temperature of the camera or the battery.
- Do not pull up the flash manually. This may cause a malfunction.
- When using the zoom function while shooting a movie, the sound of the camera operating will be recorded. The sound of the MOVIE button operating may also be recorded when movie recording is finished.

Viewing images

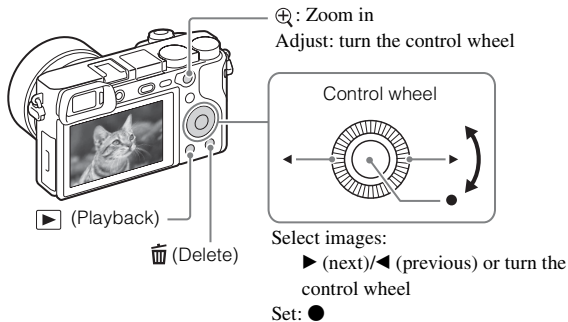

1 Press the ▶ (Playback) button.

■ Selecting next/previous image

Select an image by pressing ▶ (next)/◀ (previous) on the control wheel or by turning the control wheel. Press ● in the center of the control wheel to view movies.

■ Deleting an image

- 1 Press the 🗑️ (Delete) button.
- 2 Select [Delete] with ▲ on the control wheel, then press ●.

■ Returning to shooting images

Press the shutter button halfway down.

Introduction of other functions

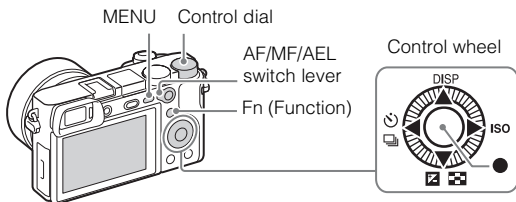

■ Control wheel

DISP (Display Contents): Allows you to change the screen display.

ISO (ISO): Allows you to set the sensitivity based on the brightness.

Image Index: Allows you to view multiple images in a single-image screen at the same time.

Exposure Comp.: Allows you to compensate the exposure and brightness for the entire image.

Drive Mode: Allows you to switch between shooting methods, such as single shooting, continuous shooting, self-timer shooting or bracket shooting.

Focus Standard: If you press this key when the [Focus Area] is set to [Zone], [Flexible Spot], or [Expand Flexible Spot], you can change the position of the focus area by pressing **▲/▼/◀/▶** on the control wheel. Also, you can change the position of the focus area while shooting still images. Depending on the options selected in [Focus Area] or [Center Lock-on AF], the available functions varies when pressing the key.

■ Fn (Function) button

Allows you to register 12 functions and recall those functions when shooting.

- ① Press the Fn (Function) button.
- ② Select the desired function by pressing **▲/▼/◀/▶** on the control wheel.
- ③ Select the setting value by turning the control wheel.

■ Control dial

You can instantly change the appropriate setting for each shooting mode just by turning the control dial.









■ AF/MF/AEL switch lever





You can switch the function of the AF/MF/AEL button to AF/MF or AEL by changing the position of the AF/MF/AEL switch lever.



When you move the AF/MF/AEL switch lever to the AF/MF position and press the button, the focusing mode temporarily switches between auto and manual (AF/MF control). When you move the AF/MF/AEL switch lever to the AEL position and press the button, the exposure is locked (AE lock).

■ Menu Items





(Camera Settings)



 Image Size	Selects the size of still images.
 Aspect Ratio	Selects the aspect ratio for still images.
 Quality	Sets the image quality for still images.
Panorama: Size	Selects the size of panoramic images.
Panorama: Direction	Sets the shooting direction for panoramic images.
 File Format	Selects the movie file format.
 Record Setting	Selects the size of the recorded movie frame.
Dual Video REC	Sets whether to simultaneously record an XAVC S movie and MP4 movie or an AVCHD movie and MP4 movie.
 HFR Settings	Sets the High Frame Rate shooting settings.
Drive Mode	Sets the drive mode, such as for continuous shooting.
Bracket Settings	Sets self-timer shooting in bracket mode, shooting order for exposure bracketing, and white balance bracketing.
Flash Mode	Sets the flash settings.
Flash Comp.	Adjusts the intensity of flash output.
Red Eye Reduction	Reduces the red-eye phenomenon when using flash.
Focus Mode	Selects the focus method.
Focus Area	Selects the area of focus.
 AF Illuminator	Sets the AF illuminator, which provides light for a dark scene to aid focusing.
 AF drive speed	Switches focusing speed when using autofocus in movie mode.





 AF Track Sens	Sets the AF tracking sensitivity in movie mode.
Exposure Comp.	Compensates for the brightness of the entire image.
Exposure step	Selects the size of the increment step for shutter speed, aperture, and exposure.
ISO	Sets the ISO sensitivity.
ISO AUTO Min. SS	Sets the slowest shutter speed at which ISO sensitivity will start to change in [ISO AUTO] mode.
Metering Mode	Selects the method for measuring brightness.
White Balance	Adjusts the color tones of an image.
DRO/Auto HDR	Compensates automatically for brightness and contrast.
Creative Style	Selects the desired image processing. You can also adjust contrast, saturation and sharpness.
Picture Effect	Selects the desired effect filter to achieve a more impressive and artistic expression.
Picture Profile	Changes settings such as color and tone.
Zoom	Sets the zoom scale for Clear Image Zoom and Digital Zoom.
Focus Magnifier	Enlarges the image before shooting so that you can check the focus.
 Long Exposure NR	Sets noise reduction processing for shots with a shutter speed of 1 second or longer.
 High ISO NR	Sets noise reduction processing for high-sensitivity shooting.
Center Lock-on AF	Sets the function to track a subject and continue focusing when pressing the center button in the shooting screen.
Smile/Face Detect.	Selects to detect faces and adjust various settings automatically. Sets to automatically release the shutter when a smile is detected.
 Soft Skin Effect	Sets the Soft Skin Effect and the effect level.
 Auto Obj. Framing	Analyzes the scene when capturing faces, close-ups, or subjects tracked by the Lock-on AF function, and automatically trims and saves another copy of the image with a more impressive composition.

Auto Mode	You can shoot selecting either Intelligent Auto or Superior Auto.
Scene Selection	Selects pre-set settings to match various scene conditions.
Movie/HFR	Selects the exposure mode to suit your subject or effect.
SteadyShot	Sets SteadyShot for shooting still images and movies. Reduces blur from camera shake when shooting while holding the camera.
 Color Space	Changes the range of reproducible colors.
 Auto Slow Shut.	Sets the function that automatically adjusts the shutter speed following the brightness of the environment.
Audio Recording	Sets whether to record audio when shooting a movie.
Audio Rec Level	Adjusts the audio recording level during movie recording.
Wind Noise Reduct.	Reduces wind noise during movie recording.
Memory recall	Calls up settings pre-registered in [Memory].
Memory	Registers the desired modes or camera settings.

(Custom Settings)

Zebra	Displays stripes to adjust brightness.
 MF Assist	Displays an enlarged image when focusing manually.
Focus Magnif. Time	Sets the length of time the image will be shown in an enlarged form.
 AF in Focus Mag.	Sets whether or not to autofocus when an enlarged image is being displayed. While the enlarged image is being displayed, you can focus within a smaller area than the flexible spot.
Grid Line	Sets a grid line display to enable alignment to a structural outline.
 Marker Display	Sets whether to display the marker on the monitor when recording movies.
 Marker Settings	Sets the marker displayed on the monitor when recording movies.
Audio Level Display	Sets Audio Level Display.

Auto Review	Sets auto review to display the captured image after shooting.
DISP Button	Sets the type of information to be displayed on the monitor or in the viewfinder by pressing DISP on the control wheel.
Peaking Level	Enhances the outline of in-focus ranges with a specific color when focusing manually.
Peaking Color	Sets the color used for the peaking function.
Exposure Set. Guide	Sets the guide displayed when exposure settings are changed in the shooting screen.
Live View Display	Sets whether or not to reflect settings such as exposure compensation in screen display.
AF Area Auto Clear	Sets whether the focus area should be displayed all the time or disappear shortly after the focus is achieved.
Disp. cont. AF area	Sets whether or not to display the focus area in [Continuous AF] mode.
 Pre-AF	Sets whether or not to perform auto focus before the shutter button is half pressed.
Zoom Setting	Sets whether to use the Clear Image Zoom and Digital Zoom when zooming.
Eye-Start AF	Sets whether to use auto focus when you look through the viewfinder if an LA-EA2/LA-EA4 Mount Adaptor (sold separately) is attached.
FINDER/MONITOR	Sets the method for switching between the viewfinder and the monitor.
 Finder Frame Rate	Sets the frame rate for the viewfinder when shooting still images.
Release w/o Lens	Sets whether or not to release the shutter when there is no lens.
Release w/o Card	Sets whether to release the shutter when a memory card is not inserted.
Priority Set in AF-S	Sets the timing of the shutter release when [Focus Mode] is set to [Single-shot AF], [DMF] or [Automatic AF] with a still subject.

Priority Set in AF-C	Sets the timing of the shutter release when [Focus Mode] is set to [Continuous AF] or [Automatic AF] with a moving subject.
 AF w/ shutter	Sets whether to perform AF when the shutter button is half pressed. This is useful when you want to adjust the focus and exposure separately.
 AEL w/ shutter	Sets whether to perform AEL when the shutter button is half pressed. This is useful when you want to adjust the focus and exposure separately.
 Silent Shooting	Shoots images without the shutter sound.
e-Front Curtain Shut.	Sets whether to use the electronic front curtain shutter function.
S. Auto Img. Extract.	When the shooting mode is set to [Superior Auto] and the camera recognizes the scene to be shot with multiple images, this sets whether to extract an image automatically and save it.
Exp.comp.set	Sets whether to reflect exposure compensation value to flash compensation.
Face Registration	Registers or changes the person to be given priority in the focus.
AF Micro Adj.	Finely adjusts the autofocused position, when using the LA-EA2 or LA-EA4 Mount Adaptor (sold separately).
Lens Comp.	Selects the type of the lens compensation.
 AF System	Sets the auto focus method when an LA-EA1/LA-EA3 Mount Adaptor (sold separately) is attached.
Function Menu Set.	Customizes the functions displayed when the Fn (Function) button is pressed.
Custom Key(Shoot.)	Assigning functions to the various keys allows you to perform operations more quickly by pressing the keys when shooting images.
Custom Key(PB)	Assigning functions to the keys allows you to perform operations more quickly by pressing the keys when playing back images.
Dial/Wheel Setup	Sets the function of the control dial and the control wheel when the exposure mode is set to M. You can adjust the shutter speed or aperture with this setting.

Dial/Wheel Ev Comp	Adjusts the exposure compensation with the control dial or the control wheel.
Zoom Ring Rotate	Assigns the zoom in/out to the rotational direction of the zoom lens. This function is only available with a power zoom lens that is compatible with this function.
MOVIE Button	Sets whether to always activate the MOVIE button.
Dial/Wheel Lock	Sets whether to disable the control dial and the control wheel temporarily by using the Fn button when shooting. You can disable/enable the control dial and the control wheel by pressing and holding down the Fn button.

(Wireless)

Send to Smartphone	Transfers images to display on a smartphone.
Send to Computer	Backs up images by transferring them to a computer connected to a network.
View on TV	You can view images on a network-enabled TV.
One-touch(NFC)	Assigns an application to One-touch (NFC). You can call up the application when shooting by touching an NFC-enabled smartphone to the camera.
Airplane Mode	You can set this device to not perform wireless communications.
WPS Push	You can register the access point to the camera easily by pushing the Wi-Fi Protected Setup™ (WPS) button.
Access Point Set.	You can register your access point manually.
Edit Device Name	You can change the device name under Wi-Fi Direct, etc.
Disp MAC Address	Displays the MAC address of the camera.
SSID/PW Reset	Resets the SSID and password for the smartphone connection.
Reset Network Set.	Resets all network settings.

(Application)



Application List	Displays the application list. You can select the application you want to use.
Introduction	Displays instructions on using the application.

(Playback)

Delete	Deletes an image.
View Mode	Sets the way in which images are grouped for playback.
Image Index	Displays multiple images at the same time.
Display Rotation	Sets the playback direction of the recorded image.
Slide Show	Shows a slide show.
Rotate	Rotates the image.
 Enlarge Image	Enlarges the playback images.
Protect	Protects the images.
Specify Printing	Adds a print order mark to a still image.

(Setup)

Monitor Brightness	Sets the monitor brightness.
Viewfinder Bright.	Sets the brightness of the electronic viewfinder.
Finder Color Temp.	Sets the color temperature of the viewfinder.
Gamma Disp. Assist	Converts an S-Log image to an ITU709-equivalent image and displays it on the viewfinder or on the monitor.
Volume Settings	Sets the volume for movie playback.
Audio signals	Sets the operating sound on/off for when the image is in focus or when the self-timer is started.
Upload Settings	Sets the upload function of the camera when using an Eye-Fi card.
Tile Menu	Sets whether to display the tile menu every time you press the MENU button.
Mode Dial Guide	Turns the mode dial guide (the explanation of each shooting mode) on or off.

Delete confirm.	Sets whether Delete or Cancel is preselected in the Delete confirmation screen.
Display Quality	Sets the display quality.
Pwr Save Start Time	Sets the time intervals to automatically switch to power save mode.
NTSC/PAL Selector*1	By changing the TV format of the device, shooting in a different movie format is possible.
Cleaning Mode	Starts the cleaning mode to clean the image sensor.
Demo Mode	Sets demonstration movie playback to on or off.
TC/UB Settings	Sets the time code (TC) and user bit (UB).
Remote Ctrl	Sets whether to use the infrared remote control.
HDMI Settings	Sets the HDMI settings.
 4K Output Sel.	Sets how to record and output 4K movies via HDMI when the camera is connected to an external recorder/player that supports 4K.
USB Connection	Sets the USB connection method.
USB LUN Setting	Enhances compatibility by limiting the functions of the USB connection.
USB Power Supply	Sets whether to supply power via USB connection when the camera is connected to a computer or USB device using a micro USB cable. If you use the supplied AC Adaptor, power will be supplied regardless of whether this setting is on or off.
 Language	Selects the language.
Date/Time Setup	Sets the date and time, and daylight savings.
Area Setting	Sets the location of use.
Copyright Info	Sets copyright information for still images.
Format	Formats the memory card.
File Number	Sets the method used to assign file numbers to still images and movies.
Set File Name	Changes the first 3 characters of the file name for still images.
Select REC Folder	Changes the selected folder for storing still images and movies (MP4).

New Folder	Creates a new folder for storing still images and movies (MP4).
Folder Name	Sets the folder name for still images.
Recover Image DB	Recovers the image database file and enables recording and playback.
Display Media Info.	Displays the remaining recording time of movies and the recordable number of still images on the memory card.
Version	Displays the camera software version.
Certification Logo* ²	The certification can be displayed on the camera.
Setting Reset	Restores settings to their defaults.

*¹ If you switch this item, it will be required to format the memory card in the setting compatible with the PAL or NTSC system respectively. Also, note that it may not be possible to play back movies recorded with the NTSC system on a PAL system TV.

*² Overseas model only

Using software

Installing the following software to your computer will make your camera experience more convenient.

- PlayMemories Home™: Imports images to your computer and lets you use them in different ways (page 36).
- Image Data Converter: Displays RAW images and processes them.
- Remote Camera Control: Controls a camera connected to your computer via a USB cable.

You can download and install this software to your computer from the following URLs.

- 1 Using the Internet browser on your computer, go to one of the following URLs, and then follow the instructions on the screen to download the desired software.

Windows:

<http://www.sony.co.jp/imsoft/Win/>

Mac:

<http://www.sony.co.jp/imsoft/Mac/>

- An Internet connection is required.
- For details on operation, refer to the support page or Help page of the software.

Notes

- When using Remote Camera Control, select the MENU button →  (Setup) → [USB Connection] → [PC Remote] and then connect the camera to your computer.

Importing images to your computer and using them (PlayMemories Home)

The software PlayMemories Home allows you to import still images and movies to your computer and use them. PlayMemories Home is required for importing XAVC S movies and AVCHD movies to your computer.

<http://www.sony.net/pm/>



Importing images from your camera

For Windows, the following functions are also available:



Viewing images on a calendar



Creating movie discs



Uploading images to network services

Playing back imported images



Sharing images on PlayMemories Online™



Notes

- An Internet connection is required to use PlayMemories Online or other network services. PlayMemories Online or other network services may not be available in some countries or regions.
- If the software PMB (Picture Motion Browser), supplied with models released before 2011, has already been installed on your computer, PlayMemories Home will overwrite it during the installation. Use PlayMemories Home, the successor software of PMB.
- When you connect the camera to your computer, new functions may be installed in PlayMemories Home. It is recommended to connect the camera to the computer even if PlayMemories Home has already been installed on the computer.
- Do not disconnect the micro USB cable (supplied) from the camera while the operating screen or the accessing screen is displayed. Doing so may damage the data.
- To disconnect the camera from the computer, click  on the tasktray, then click [Eject ILCE-6300].

Adding functions to the camera

You can add the desired functions to your camera by connecting to the application download website  (PlayMemories Camera Apps™) via the Internet.

<http://www.sony.net/pmca/>

- After installing an application, you can call up the application by touching an NFC-enabled Android smartphone to the N mark on the camera, using the [One-touch(NFC)] function.

Number of still images and recordable time of movies

The number of still images and recordable time may vary depending on the shooting conditions and the memory card.



■ Still images

The table below shows the approximate number of images that can be recorded on a memory card formatted with this camera. The values are defined using Sony standard memory cards for testing.

 **Image Size]: L: 24M**

When  **Aspect Ratio] is set to [3:2]***

Quality	Number of still images	
	8 GB	64 GB
Standard	1300 images	10500 images
Fine	820 images	6600 images
Extra fine	405 images	3250 images
RAW & JPEG	215 images	1750 images
RAW	295 images	2400 images

* When the  Aspect Ratio] is set to other than [3:2], you can record more pictures than shown above. (Except when  Quality] is set to [RAW].)

Movies

The table below shows the approximate total recording times using a memory card formatted with this camera. The recording time for XAVC S and AVCHD movies is the recording time when shooting with [Dual Video REC] set to [Off].

File Format	Record Setting	Recordable time (h (hour), m (minute))		
		8 GB	32 GB	64 GB
XAVC S 4K	30p 100M/25p 100M ^{Super} / _{35mm}	9 m	35 m	1 h 15 m
	30p 60M/25p 60M ^{Super} / _{35mm}	15 m	1 h	2 h 5 m
	24p 100M ^{Super} *1/ _{35mm} / -	9 m	35 m	1 h 15 m
	24p 60M ^{Super} *1/ _{35mm} / -	15 m	1 h	2 h 5 m
XAVC S HD	60p 50M ^{Super} / _{35mm} / 50p 50M ^{Super} / _{35mm}	15 m	1 h 15 m	2 h 35 m
	30p 50M ^{Super} / _{35mm} / 25p 50M ^{Super} / _{35mm}	15 m	1 h 15 m	2 h 35 m
	24p 50M ^{Super} *1/ _{35mm} / -	15 m	1 h 15 m	2 h 35 m
	120p 100M/100p 100M	9 m	35 m	1 h 15 m
	120p 60M/100p 60M	15 m	1 h	2 h 5 m
	30p 16M*2/25p 16M*2	10 m	55 m	1 h 55 m
	24p 12M*1*2/ -	10 m	55 m	1 h 55 m
AVCHD	60i 24M(FX) ^{Super} / _{35mm} / 50i 24M(FX) ^{Super} / _{35mm}	40 m	3 h	6 h
	60i 17M(FH) ^{Super} / _{35mm} / 50i 17M(FH) ^{Super} / _{35mm}	55 m	4 h 5 m	8 h 15 m
	60p 28M(PS) ^{Super} / _{35mm} / 50p 28M(PS) ^{Super} / _{35mm}	35 m	2 h 30 m	5 h 5 m
	24p 24M(FX) ^{Super} / _{35mm} / 25p 24M(FX) ^{Super} / _{35mm}	40 m	3 h	6 h
	24p 17M(FH) ^{Super} / _{35mm} / 25p 17M(FH) ^{Super} / _{35mm}	55 m	4 h 5 m	8 h 15 m
	MP4	1080/60p 28M ^{Super} / _{35mm} / 1080/50p 28M ^{Super} / _{35mm}	35 m	2 h 35 m
1080/30p 16M ^{Super} / _{35mm} / 1080/25p 16M ^{Super} / _{35mm}		1 h	4 h 10 m	8 h 25 m
720/30p 6M ^{Super} / _{35mm} / 720/25p 6M ^{Super} / _{35mm}		2 h 35 m	10 h 55 m	22 h

*1 Only when [NTSC/PAL Selector] is set to NTSC

*2 File format for High Frame Rate shooting (The values shown are available recording times when shooting, not durations when playing back.)

- Continuous shooting is possible for approximately 29 minutes (a product specification limit). However, the duration of time available for continuous movie recording varies under the following conditions.
 - High Frame Rate shooting: Approximately 7 minutes at [30p 16M]/[25p 16M]; approximately 5 minutes 30 seconds at [24p 12M]
 - When the file format is set to MP4 (28M): Approximately 20 minutes (limited by file size of 4 GB)
- The recordable time of movies varies because the camera is equipped with VBR (Variable Bit-Rate), which automatically adjusts image quality depending on the shooting scene. When you record a fast-moving subject, the image is clearer but the recordable time is shorter because more memory is required for recording. The recordable time also varies depending on the shooting conditions, the subject or the image quality/size settings.

Notes on continuous movie recording

- It requires a lot of power to perform high quality movie recording or continuous shooting using the image sensor. Therefore, if you continue to shoot, the temperature inside the camera will rise, especially that of the image sensor. In such cases, the camera turns off automatically since higher temperatures affect the quality of the images or affect the internal mechanism of the camera.
- The duration of time available for movie recording is as follows when the camera starts recording with the camera's default settings after the power of the camera has been turned off for a while. (The following values indicate the continuous time from when the camera starts recording until the camera stops recording.)

Ambient temperature	Continuous recording time for movies (HD)	Continuous recording time for movies (4K)
20°C (68°F)	About 29 minutes	About 20 minutes
30°C (86°F)	About 29 minutes	About 20 minutes
40°C (104°F)	About 29 minutes	About 20 minutes

HD: XAVC S HD 60p 50M/50p 50M

4K: XAVC S 4K 24p 60M

- The duration of time available for movie recording varies with the temperature, the recording format/setting, or condition of the camera before you start recording. If you frequently recompose or shoot images after the power is turned on, the temperature inside the camera will rise and the recording time available will be shorter.
- When [I] is indicated, stop recording the movie.
- If the camera stops recording due to the temperature, leave it for several minutes with the power turned off. Start recording after the temperature inside the camera drops fully.

Notes on using the camera

Functions built into this camera

- This camera is compatible with 1080 60p or 50p-format movies. Unlike standard recording modes up to now, which record in an interlacing method, this camera records using a progressive method. This increases the resolution, and provides a smoother, more realistic image.
- This camera is compatible with 4K 30p/4K 25p/4K 24p recording. Movies can be recorded in a higher resolution than HD format.

On use and care

Avoid rough handling, disassembling, modifying, physical shock, or impact such as hammering, dropping, or stepping on the product. Be particularly careful of the lens.

Notes on recording/playback

- Before you start recording, make a trial recording to make sure that the camera is working correctly.
- This camera is designed to be dust and moisture-resistant, but is not waterproof or splash-proof.
- Do not directly expose the lens to beams such as laser beams. That may damage the image sensor and cause the camera to malfunction.
- Do not look at the sun or a strong light through a removed lens. This may cause irrecoverable damage to your eyes. Or it may cause a malfunction of the lens.
- If moisture condensation occurs, remove it before using the camera.
- Do not shake or strike the camera. It may cause a malfunction and you may not be able to record images. Furthermore, the recording media may become unusable or image data may be damaged.

Do not use/store the camera in the following places

- In an extremely hot, cold or humid place
In places such as in a car parked in the sun, the camera body may become deformed and this may cause a malfunction.
- Under direct sunlight or near a heater
The camera body may become discolored or deformed, and this may cause a malfunction.
- In a location subject to shaking or vibration
- Near a location that generates strong radio waves, emits radiation or is strongly magnetic
In such locations, the camera may not properly record or play back images.
- In sandy or dusty places
Be careful not to let sand or dust get into the camera. This may cause the camera to malfunction, and in some cases this malfunction cannot be repaired.

On storing

^{GB} Be sure to attach the front lens cap when not using the camera.

Notes on the monitor, electronic viewfinder and lens

- The monitor and electronic viewfinder are manufactured using extremely high-precision technology, and over 99.99% of the pixels are operational for effective use. However, some tiny black and/or bright dots (white, red, blue or green) may appear on the monitor and electronic viewfinder. These dots are a normal result of the manufacturing process, and do not affect the recording.
- Do not hold the camera by the monitor.
- When the lens is operating, be careful not to let your finger be caught by the lens.

About the magnets

There are magnets attached to the back of the monitor and in the area around the flash. Do not put objects that are affected by magnetic fields, such as a floppy disk or a credit card to the monitor or the camera body.

Notes on shooting with the viewfinder

When shooting with the viewfinder, you may experience symptoms such as eyestrain, fatigue, travel sickness, or nausea. We recommend that you take a break at regular intervals when you are shooting with the viewfinder.

The required length or frequency of the break may differ depending on the individuals, so you are advised to decide at your own discretion. In case you may feel uncomfortable, refrain from using the viewfinder until your condition recovers, and consult your doctor as necessary.

On using the lenses and accessories

It is recommended that you use Sony lenses/accessories designed to suit the characteristics of this camera.

Using the products of other manufacturers may cause the camera not to operate to its capability, or result in accidents and malfunctions of the camera.

Notes on the flash

- Do not carry the camera by the flash unit, or use excessive force on it.
- If water, dust or sand get into the open flash unit, it may cause a malfunction.
- Be sure to keep your fingers out of the way when you press the flash down.

On camera's temperature

Camera body and battery may get warm with use – this is normal.

On the overheat protection

Depending on the camera and battery temperature, you may be unable to record movies or the power may turn off automatically to protect the camera.

A message will be displayed on the monitor before the power turns off or when you can no longer record movies. In this case, leave the power off and wait until the camera and battery temperature goes down. If you turn on the power without letting the camera and battery cool down enough, the power may turn off again or you may be unable to record movies.

On charging the battery

If you charge a battery that has not been used for a long time, you may be unable to charge it to the proper capacity.

This is due to the battery characteristics. Charge the battery again.

Warning on copyright

- Television programs, films, videotapes, and other materials may be copyrighted. Unauthorized recording of such materials may be contrary to the provisions of the copyright laws.
- To prevent [Copyright Info] from being used illegally, leave [Set Photographer] and [Set Copyright] blank when you lend or transfer the camera.
- Sony bears no responsibility for any trouble or damage caused by unauthorized use of [Copyright Info].

No guarantee in the case of damaged content or recording failures

Sony can provide no guarantees in the event of failure to record or loss or damage of recorded images or audio data due to a malfunction of the camera or recording media, etc. We recommend backing up important data.

Cleaning the camera surface

Clean the camera surface with a soft cloth slightly moistened with water, then wipe the surface with a dry cloth. To prevent damage to the finish or casing:

- Do not expose the camera to chemical products such as thinner, benzine, alcohol, disposable cloths, insect repellent, sunscreen or insecticide.

Maintaining the monitor

- Hand cream or moisturizer left on the monitor may dissolve its coating. If you get any of these substances on the monitor, wipe it off immediately.
- Wiping forcefully with tissue paper or other materials can damage the coating.
- If fingerprints or debris are stuck to the monitor, we recommend that you gently remove any debris and then wipe the monitor clean with a soft cloth.

Notes on wireless LAN

We assume no responsibility whatsoever for any damage caused by unauthorized access to, or unauthorized use of, destinations loaded on the camera, resulting from loss or theft.

Notes on security when using wireless LAN products

- Always make sure that you are using a secure wireless LAN to avoid hacking, access by malicious third parties, or other vulnerabilities.
- It is important that you set the security settings when using a wireless LAN.
- If a security problem arises because no security precautions are in place or due to any inevitable circumstances when using a wireless LAN, Sony bears no responsibility for the loss or damage.

Specifications

Camera

[System]

Camera type: Interchangeable lens digital camera

Lens: Sony E-mount lens

[Image sensor]

Image sensor: APS-C format (23.5 mm × 15.6 mm) CMOS image sensor

Effective pixel number of camera:
Approx. 24 200 000 pixels

Total pixel number of image sensor:
Approx. 25 000 000 pixels

[Anti-Dust]

System: Charge protection coating on Optical Filter and ultrasonic vibration mechanism

[Auto focus system]

System: Phase detection system/
Contrast detection system

Sensitivity range: EV-1 to EV20 (at ISO 100 equivalent, with F2.0 lens)

[Exposure control]

Metering method: 1 200-segment metering by the image sensor

Metering range: EV-2 to EV20 (at ISO 100 equivalent, with F2.0 lens)

ISO sensitivity (Recommended exposure index):

Still images: AUTO, ISO 100 – ISO 25 600 (Extended ISO:

Maximum ISO 51 200)

Movies: AUTO, ISO 100 – ISO 25 600 equivalent

Exposure compensation: ±5.0 EV (switchable between 1/3 and 1/2 EV steps)

[Shutter]

Type: Electronically-controlled, vertical-traverse, focal-plane type

Speed range:

Still images: 1/4 000 second to 30 seconds, BULB

Movies: 1/4 000 second to 1/4 second (1/3 EV step)

– 1080 60i-compatible device up to 1/60 second in AUTO mode (up to 1/30 second in Auto slow shutter mode)

– 1080 50i-compatible device up to 1/50 second in AUTO mode (up to 1/25 second in Auto slow shutter mode)

Flash sync speed: 1/160 second

[Recording media]

Memory Stick PRO Duo media, SD card

[Monitor]

LCD monitor: Wide, 7.5 cm (3.0 type) TFT drive

Total number of dots: 921 600 dots

[Electronic viewfinder]

Type: Electronic viewfinder

Total number of dots: 2 359 296 dots

Frame coverage: 100%

Magnification:

Approx. 1.07 ×

Approx. 0.70 × (35 mm-format equivalent) with 50 mm lens at infinity, -1 m^{-1} (diopter)

Eye point (CIPA compliant):
Approx. 23 mm from the eyepiece,
approx. 21.4 mm from the eyepiece
frame at -1 m^{-1}
Diopter Adjustment: -4.0 m^{-1} to
 $+3.0 \text{ m}^{-1}$

[Input/output terminals]

Multi/Micro USB Terminal*:
Hi-Speed USB (USB 2.0)
* Supports Micro USB compatible
device.
HDMI: HDMI type D micro jack
🔊 (Microphone) Terminal:
Ø 3.5 mm Stereo mini jack

[Power]

Battery type: Rechargeable battery
pack NP-FW50

[Power consumption (while shooting)]

When using an E PZ 16 – 50 mm F3.5
– 5.6 OSS lens*
Approx. 2.5 W (during shooting
with the viewfinder)
Approx. 2.2 W (during shooting
with the monitor)
* supplied with ILCE-6300L

[Others]

Exif Print: Compatible
PRINT Image Matching III:
Compatible
DPOF: Compatible
Dimensions (CIPA compliant)
(Approx.):
120.0 mm × 66.9 mm × 48.8 mm
(4 3/4 inches × 2 3/4 inches ×
1 15/16 inches) (W/H/D)

Mass (CIPA compliant) (Approx.):
404 g (14.3 oz)
(including battery and Memory
Stick PRO Duo media)
361 g (12.8 oz) (camera only)
Operating temperature: 0 °C to 40 °C
(32 °F to 104 °F)
Storage temperature: -20 °C to $+60 \text{ °C}$
(-4 °F to $+140 \text{ °F}$)

File format:

Still image: JPEG compliant (DCF
Ver. 2.0, Exif Ver. 2.3, MPF
Baseline), RAW (Sony ARW 2.3
Format)

Movies (XAVC S format):

MPEG-4 AVC/H.264 XAVC S
ver.1.0 format compliant
Video: MPEG-4 AVC/H.264
Audio: LPCM 2ch (48 kHz 16 bit)
Movie (AVCHD format): AVCHD
format Ver. 2.0 compatible
Video: MPEG-4 AVC/H.264
Audio: Dolby Digital 2ch
Dolby Digital Stereo Creator

• Manufactured under license from
Dolby Laboratories.

Movie (MP4 format):

Video: MPEG-4 AVC/H.264
Audio: MPEG-4 AAC-LC 2ch
USB communication: Hi-Speed
USB (USB 2.0)

[Flash]

Flash guide number: 6 (in meters at
ISO 100)
Recycling time: Approx. 4 seconds
Flash coverage: Covering 16 mm lens
(focal length that the lens indicates)
Flash compensation: $\pm 3.0 \text{ EV}$
(switchable between 1/3 and
1/2 EV steps)

[Wireless LAN]

Supported format: IEEE 802.11 b/g/n
Frequency band: 2.4 GHz
Supported security protocols: WEP/
WPA-PSK/WPA2-PSK
Configuration method: Wi-Fi Protected
Setup (WPS)/Manual
Access method: Infrastructure mode
NFC: NFC Forum Type 3 Tag-
compliant

Model No. WW906746

AC Adaptor AC-UUD12/UUE12

Power requirements: AC 100 V to
240 V, 50 Hz/60 Hz, 0.2 A
Output voltage: DC 5 V, 1.5 A

Rechargeable battery pack NP-FW50

Battery type: Lithium-ion battery
Maximum voltage: DC 8.4 V
Nominal voltage: DC 7.2 V
Maximum charge voltage: DC 8.4 V
Maximum charge current: 1.02 A
Capacity: 7.3 Wh (1 020 mAh)

Lens E PZ 16 – 50 mm F3.5 – 5.6 OSS*1 (supplied with ILCE-6300L)

Equivalent 35 mm-format focal
length*2: 24 mm – 75 mm
Lens groups – elements: 8 – 9
Angle of view*2: 83° – 32°
Minimum focus*3: 0.25 m – 0.3 m
(0.82 feet – 1 feet)
Maximum magnification: 0.215×
Minimum aperture: f/22 – f/36
Filter diameter: 40.5 mm
Dimensions (max. diameter × height):
Approx. 64.7 mm × 29.9 mm
(2 5/8 in. × 1 3/16 in.)
Mass: Approx. 116 g (4.1 oz.)
SteadyShot: Available

*1 Power zoom lens

*2 The values for equivalent 35 mm-
format focal length and angle of
view are based on digital cameras
equipped with an APS-C sized
image sensor.



*3 Minimum focus is the shortest
distance from the image sensor to the
subject.

Design and specifications are subject
to change without notice.

On focal length

The picture angle of this camera is
narrower than that of a 35 mm-format
camera. You can find the approximate
equivalent of the focal length of a
35 mm-format camera, and shoot with
the same picture angle, by increasing
the focal length of your lens by half.
For example, by using a 50 mm lens,
you can get the approximate equivalent
of a 75 mm lens of a 35 mm-format
camera.

Trademarks

- Memory Stick and  are trademarks or registered trademarks of Sony Corporation.
- XAVC S and  are registered trademarks of Sony Corporation.
- “AVCHD Progressive” and “AVCHD Progressive” logotype are trademarks of Panasonic Corporation and Sony Corporation.
- Dolby and the double-D symbol are trademarks of Dolby Laboratories.
- The terms HDMI and HDMI High-Definition Multimedia Interface, and the HDMI Logo are trademarks or registered trademarks of HDMI Licensing LLC in the United States and other countries.
- Windows is a registered trademark of Microsoft Corporation in the United States and/or other countries.
- Mac is a registered trademark of Apple Inc. in the United States and other countries.
- iPhone and iPad are registered trademarks of Apple Inc. in the United States and other countries.
- SDXC logo is a trademark of SD-3C, LLC.
- Android and Google Play are trademarks of Google Inc.
- Wi-Fi, the Wi-Fi logo, Wi-Fi Protected Setup are registered trademarks or trademarks of the Wi-Fi Alliance.
- The N Mark is a trademark or registered trademark of NFC Forum, Inc. in the United States and in other countries.
- DLNA and DLNA CERTIFIED are trademarks of Digital Living Network Alliance.
- Facebook and the “f” logo are trademarks or registered trademarks of Facebook, Inc.
- YouTube and the YouTube logo are trademarks or registered trademarks of Google Inc.
- Eye-Fi is a trademark of Eye-Fi, Inc.
- In addition, system and product names used in this manual are, in general, trademarks or registered trademarks of their respective developers or manufacturers. However, the ™ or ® marks may not be used in all cases in this manual.



On GNU GPL/LGPL applied software

The software that is eligible for the following GNU General Public License (hereinafter referred to as “GPL”) or GNU Lesser General Public License (hereinafter referred to as “LGPL”) are included in the product.

This informs you that you have a right to have access to, modify, and redistribute source code for these software programs under the conditions of the supplied GPL/LGPL.

Source code is provided on the web. Use the following URL to download it.

<http://oss.sony.net/Products/Linux/>

We would prefer you do not contact us about the contents of source code. Licenses (in English) are recorded in the internal memory of your product. Establish a Mass Storage connection between the product and a computer to read licenses in the “PMHOME” - “LICENSE” folder.



<http://www.sony.net/SonyInfo/Support/>

Additional information on this product and answers to frequently asked questions can be found at our Customer Support Website.

<http://www.sony.net/>



4579410120

© 2016 Sony Corporation Printed in Thailand