

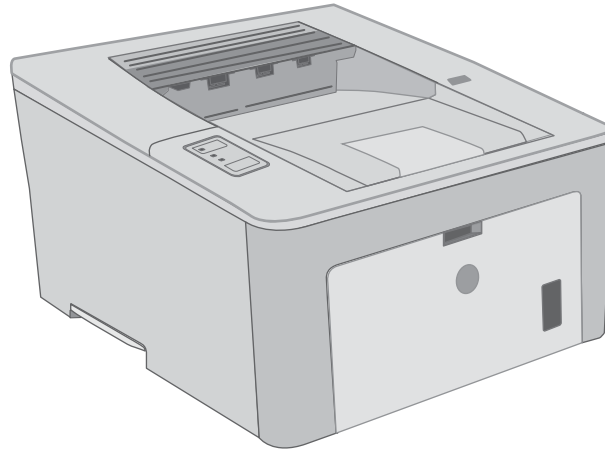

# LaserJet Pro M118-M119, M203-M205 LaserJet Ultra M206

## User Guide



**M118-M119  
M203-M206**



[www.hp.com/support/ljM118](http://www.hp.com/support/ljM118)  
[www.hp.com/support/ljM203](http://www.hp.com/support/ljM203)





HP LaserJet Pro M118-M119, M203-M205  
HP LaserJet Ultra M206

User Guide

## Copyright and License

© Copyright 2018 HP Development Company, L.P.

Reproduction, adaptation, or translation without prior written permission is prohibited, except as allowed under the copyright laws.

The information contained herein is subject to change without notice.

The only warranties for HP products and services are set forth in the express warranty statements accompanying such products and services. Nothing herein should be construed as constituting an additional warranty. HP shall not be liable for technical or editorial errors or omissions contained herein.

Edition 3, 6/2018

## Trademark Credits

Adobe®, Adobe Photoshop®, Acrobat®, and PostScript® are trademarks of Adobe Systems Incorporated.

Apple and the Apple logo are trademarks of Apple Inc., registered in the U.S. and other countries.

macOS is a trademark of Apple Inc., registered in the U.S. and other countries.

AirPrint is a trademark of Apple Inc., registered in the U.S. and other countries.

iPad is a trademark of Apple Inc., registered in the U.S. and other countries.

iPod is a trademark of Apple Inc., registered in the U.S. and other countries.

iPhone is a trademark of Apple Inc., registered in the U.S. and other countries.

Microsoft®, Windows®, Windows® XP, and Windows Vista® are U.S. registered trademarks of Microsoft Corporation.

UNIX® is a registered trademark of The Open Group.

---

# Table of contents

<b>1 Printer overview .....</b>	<b>1</b>
Printer views .....	2
Printer front view .....	2
Printer back view .....	3
Control panel view .....	4
Printer specifications .....	5
Technical specifications .....	5
Supported operating systems .....	5
Mobile printing solutions .....	7
Printer dimensions .....	7
Power consumption, electrical specifications, and acoustic emissions .....	8
Operating environmental range .....	8
Printer hardware setup and software installation .....	9
<b>2 Paper trays .....</b>	<b>11</b>
Load the Priority input tray .....	12
Introduction .....	12
Priority input tray paper orientation .....	14
Load the Main input tray .....	15
Introduction .....	15
Main input tray paper orientation .....	18
Load and print envelopes .....	19
Introduction .....	19
Print envelopes .....	19
Envelope orientation .....	20
Load and print labels .....	21
Introduction .....	21
Manually feed labels .....	21
Label orientation .....	22

<b>3 Supplies, accessories, and parts</b> .....	<b>23</b>
Order supplies, accessories, and parts .....	24
Ordering .....	24
Supplies and accessories .....	24
Configure the HP toner-cartridge-protection supply settings .....	25
Introduction .....	25
Enable or disable the Cartridge Policy feature .....	25
Use the HP Embedded Web Server (EWS) to enable the Cartridge Policy feature .....	25
Use the HP Embedded Web Server (EWS) to disable the Cartridge Policy feature .....	26
Troubleshoot Cartridge Policy control panel error messages .....	26
Enable or disable the Cartridge Protection feature .....	27
Use the HP Embedded Web Server (EWS) to enable the Cartridge Protection feature .....	27
Use the HP Embedded Web Server (EWS) to disable the Cartridge Protection feature .....	27
Troubleshoot Cartridge Protection control panel error messages .....	28
Replace the toner cartridge .....	29
Introduction .....	29
Toner-cartridge information .....	29
Remove and replace the toner cartridge .....	30
Replace the imaging drum .....	33
Introduction .....	33
Imaging drum information .....	33
Remove and replace the imaging drum .....	34
<b>4 Print</b> .....	<b>37</b>
Print tasks (Windows) .....	38
How to print (Windows) .....	38
Automatically print on both sides (Windows) .....	38
Manually print on both sides (Windows) .....	39
Print multiple pages per sheet (Windows) .....	39
Select the paper type (Windows) .....	40
Additional print tasks .....	41
Print tasks (OS X) .....	42
How to print (OS X) .....	42
Automatically print on both sides (OS X) .....	42
Manually print on both sides (OS X) .....	42
Print multiple pages per sheet (OS X) .....	43
Select the paper type (OS X) .....	43
Additional print tasks .....	44
Mobile printing .....	45
Introduction .....	45
Wi-Fi Direct (wireless models only) .....	45

Enable or disable Wi-Fi Direct .....	46
Change the printer Wi-Fi Direct name .....	47
HP ePrint via email .....	48
HP ePrint software .....	48
AirPrint .....	49
Android embedded printing .....	49
<b>5 Manage the printer .....</b>	<b>51</b>
Change the printer connection type (Windows) .....	52
Advanced configuration with HP Embedded Web Server (EWS) and HP Device Toolbox (Windows) .....	53
Advanced configuration with HP Utility for OS X .....	56
Open HP Utility .....	56
HP Utility features .....	56
Configure IP network settings .....	58
Introduction .....	58
Printer sharing disclaimer .....	58
View or change network settings .....	58
Rename the printer on a network .....	58
Manually configure IPv4 TCP/IP parameters .....	59
Link speed and duplex settings .....	60
Printer security features .....	61
Introduction .....	61
Assign or change the system password using the HP Embedded Web Server .....	61
Lock the formatter .....	62
Configure the Quiet Print Mode settings .....	63
Introduction .....	63
Configure the Quiet Print Mode settings from HP Embedded Web Server (EWS) .....	63
Energy-conservation settings .....	64
Introduction .....	64
Print with EconoMode .....	64
Set the Sleep/Auto Off After Inactivity setting .....	64
Set the Shut Down After Inactivity delay and configure the printer to use 1 watt or less of power ....	65
Set the Delay Shut Down setting .....	66
Update the firmware .....	68
Update the firmware using the Firmware Update Utility .....	68
<b>6 Solve problems .....</b>	<b>69</b>
Customer support .....	70
Interpret control-panel light patterns .....	71
Restore the factory-set defaults .....	74
A “Cartridge is low” or “Cartridge is very low” message displays on the printer control panel .....	75

Change the “Very Low” settings .....	75
Order supplies .....	76
Printer does not pick up paper or misfeeds .....	77
Introduction .....	77
The printer does not pick up paper .....	77
The printer picks up multiple sheets of paper .....	78
Clear paper jams .....	80
Introduction .....	80
Jam locations .....	80
Experiencing frequent or recurring paper jams? .....	81
Clear jams in the Main input tray .....	83
Clear jams in the toner-cartridge area .....	87
Clear jams in the output bin .....	91
Clear jams in the duplexer .....	93
Improve print quality .....	96
Introduction .....	96
Print from a different software program .....	96
Check the paper-type setting for the print job .....	96
Check the paper type setting (Windows) .....	96
Check the paper type setting (OS X) .....	97
Check toner-cartridge status .....	97
Clean the printer .....	97
Print a cleaning page .....	97
Visually inspect the toner cartridge and imaging drum .....	98
Check paper and the printing environment .....	98
Step one: Use paper that meets HP specifications .....	98
Step two: Check the environment .....	98
Step three: Set the individual tray alignment .....	99
Try a different print driver .....	100
Check the EconoMode settings .....	101
Adjust Print Density .....	101
Solve wired network problems .....	103
Introduction .....	103
Poor physical connection .....	103
The computer is using the incorrect IP address for the printer .....	103
The computer is unable to communicate with the printer .....	103
The printer is using incorrect link speed and duplex settings for the network .....	104
New software programs might be causing compatibility problems .....	104
The computer or workstation might be set up incorrectly .....	104
The printer is disabled, or other network settings are incorrect .....	104
Solve wireless network problems .....	105



Introduction .....	105
Wireless connectivity checklist .....	105
The printer does not print after the wireless configuration completes .....	106
The printer does not print, and the computer has a third-party firewall installed .....	106
The wireless connection does not work after moving the wireless router or printer .....	106
Cannot connect more computers to the wireless printer .....	106
The wireless printer loses communication when connected to a VPN .....	107
The network does not appear in the wireless networks list .....	107
The wireless network is not functioning .....	107
Perform a wireless network diagnostic test .....	107
Reduce interference on a wireless network .....	108

<b>Index .....</b>	<b>109</b>
--------------------	------------



---

# 1 Printer overview

- [Printer views](#)
- [Printer specifications](#)
- [Printer hardware setup and software installation](#)

## For more information:

The following information is correct at the time of publication. For current information, see [www.hp.com/support/ljM118](http://www.hp.com/support/ljM118), [www.hp.com/support/ljM203](http://www.hp.com/support/ljM203).

HP's all-inclusive help for the printer includes the following information:

- Install and configure
- Learn and use
- Solve problems
- Download software and firmware updates
- Join support forums
- Find warranty and regulatory information

## Printer views

- [Printer front view](#)
- [Printer back view](#)
- [Control panel view](#)

### Printer front view

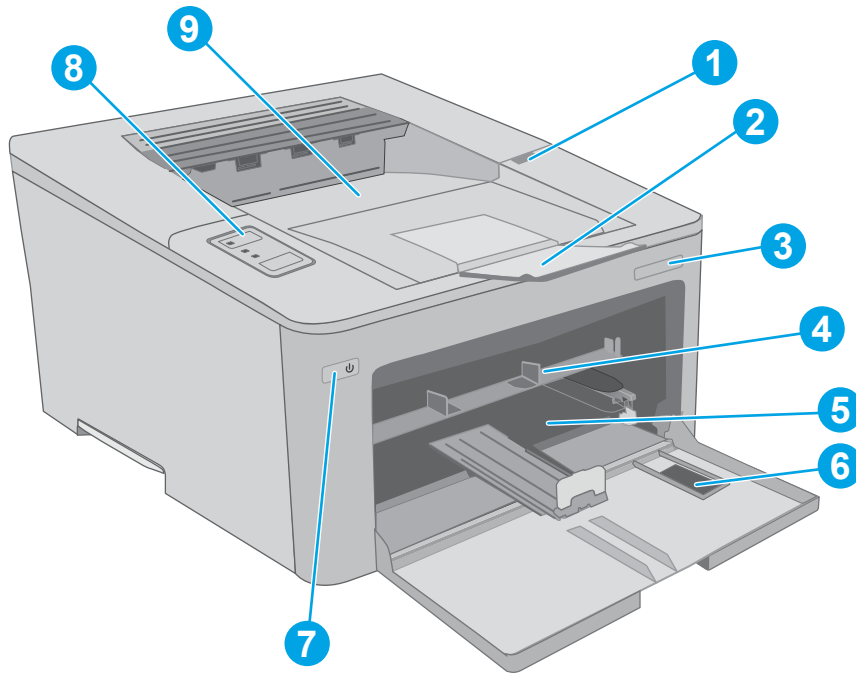

---

1	Toner cartridge door
2	Output bin extension
3	Model name
4	Priority input tray
5	Main input tray
6	Main input tray door
7	Power button
8	Control panel
9	Output bin

---

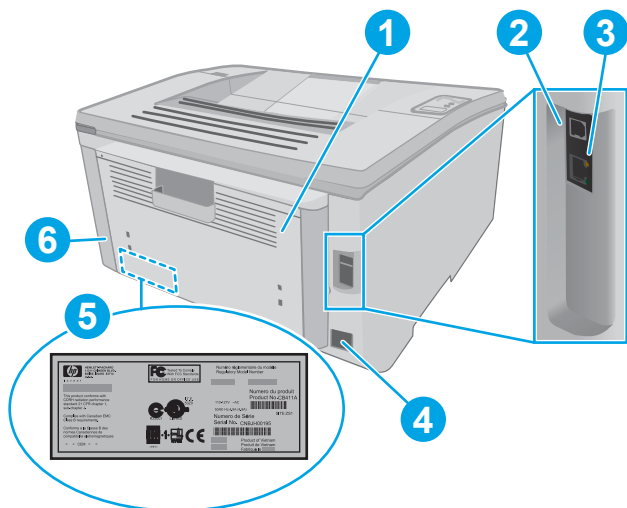

## Printer back view

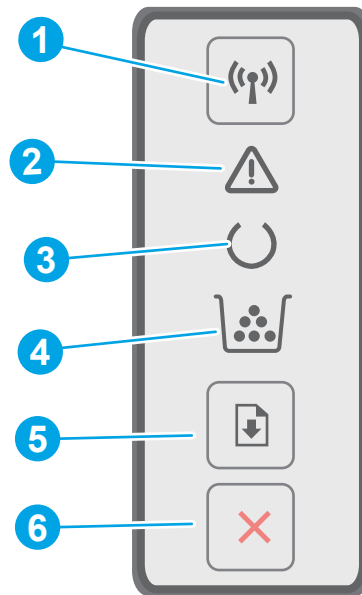

1	Rear door (access for clearing jams)
2	USB interface port
3	Ethernet port
4	Power connection
5	Serial number and product number label
6	Slot for cable-type security lock

## Control panel view



1	Wireless  button and LED (wireless models only)	Press this button to turn the wireless feature on or off, or to configure a WiFi Direct connection.  Press and hold this button to configure a WPS connection.  If the wireless LED light is on, there is a stable wireless connection. If it is blinking, there is either a WPS or WiFi Direct configuration process in progress. If it is blinking rapidly, there is an issue with the wireless connection.
2	Attention LED	The Attention light blinks when the printer requires user attention. If the Attention light is on, the printer is in an error state.
3	Ready LED	The Ready light is on when the printer is ready to print. It blinks when the printer is receiving print data.
4	Supplies LED	The Supplies light is on when the toner cartridge is very low. It blinks when there is a toner cartridge or imaging drum error.
5	Resume  button	Press this button to begin a print job.  If the printer is in an error state, press the Resume button to clear the error and resume printing.  In manual duplex mode, press the Resume button to print the second side of the page.
6	Cancel  button	Press this button to cancel a print job.

# Printer specifications

 **IMPORTANT:** The following specifications are correct at the time of publication, but they are subject to change. For current information, see [www.hp.com/support/ljM118](http://www.hp.com/support/ljM118), [www.hp.com/support/ljM203](http://www.hp.com/support/ljM203).

- [Technical specifications](#)
- [Supported operating systems](#)
- [Mobile printing solutions](#)
- [Printer dimensions](#)
- [Power consumption, electrical specifications, and acoustic emissions](#)
- [Operating environmental range](#)

## Technical specifications

See [www.hp.com/support/ljM118](http://www.hp.com/support/ljM118), [www.hp.com/support/ljM203](http://www.hp.com/support/ljM203) for current information.

## Supported operating systems

The following information applies to the printer-specific Windows PCL 6 and HP print drivers for OS X and to the software installation.

**Windows:** The HP Software Installer installs the "HP PCL.6", the "HP PCL 6", or the "HP PCL-6" print driver, depending on the Windows operating system, along with optional software when using the full software installer. Download the "HP PCL.6", the "HP PCL 6", and the "HP PCL-6" print driver from the support website for this printer: [www.hp.com/support/ljM118](http://www.hp.com/support/ljM118), [www.hp.com/support/ljM203](http://www.hp.com/support/ljM203)

**Mac computers and OS X:** Mac computers are supported with this printer. Download HP Easy Start either from [123.hp.com](http://123.hp.com) or from the support website, and then use HP Easy Start to install the HP print driver.

1. Go to [123.hp.com](http://123.hp.com).
2. Follow the steps provided to download the printer software.

**Linux:** For information and print drivers for Linux, go to [hplipopensource.com/hplip-web/index.html](http://hplipopensource.com/hplip-web/index.html)

**UNIX:** For information and print drivers for UNIX®, go to [www.hp.com/go/unixmodelscripts](http://www.hp.com/go/unixmodelscripts)

**Table 1-1** Supported operating systems and print drivers

Operating system	Print driver installed (from the software on the web)	Notes
Windows® XP SP3, 32-bit	The "HP PCL.6" printer-specific print driver is installed for this operating system as part of the software installation.	Microsoft retired mainstream support for Windows XP in April 2009. HP will continue to provide best effort support for the discontinued XP operating system. Some features of the print driver are not supported.
Windows Vista®, 32-bit	The "HP PCL.6" printer-specific print driver is installed for this operating system as part of the software installation.	Microsoft retired mainstream support for Windows Vista in April 2012. HP will continue to provide best effort support for the discontinued Vista operating system. Some features of the print driver are not supported.

**Table 1-1 Supported operating systems and print drivers (continued)**

Operating system	Print driver installed (from the software on the web)	Notes
Windows 7, 32-bit and 64-bit	The “HP PCL 6” printer-specific print driver is installed for this operating system as part of the software installation.	
Windows 8, 32-bit and 64-bit	The “HP PCL 6” printer-specific print driver is installed for this operating system as part of the software installation.	Windows 8 RT support is provided through Microsoft IN OS Version 4, 32-bit driver.
Windows 8.1, 32-bit and 64-bit	The “HP PCL-6” V4 printer-specific print driver is installed for this operating system as part of the software installation.	Windows 8.1 RT support is provided through Microsoft IN OS Version 4, 32-bit driver.
Windows 10, 32-bit and 64-bit	The “HP PCL-6” V4 printer-specific print driver is installed for this operating system as part of the software installation.	
Windows Server 2008 SP2, 32-bit	The “HP PCL-6” printer-specific print driver is available for download from the printer-support website. Download the driver, and then use the Microsoft Add Printer tool to install it.	Microsoft retired mainstream support for Windows Server 2008 in January 2015. HP will continue to provide best effort support for the discontinued Server 2008 operating system. Some features of the print driver are not supported.
Windows Server 2008 SP2, 64-bit	The “HP PCL 6” printer-specific print driver is available for download from the printer-support website. Download the driver, and then use the Microsoft Add Printer tool to install it.	Microsoft retired mainstream support for Windows Server 2008 in January 2015. HP will continue to provide best effort support for the discontinued Server 2008 operating system.
Windows Server 2008 R2, SP 1, 64-bit	The “HP PCL 6” printer-specific print driver is installed for this operating system as part of the software installation.	
Windows Server 2012, 64-bit	The “HP PCL 6” printer-specific print driver is installed for this operating system as part of the software installation.	
Windows Server 2012 R2, 64-bit	The “HP PCL-6” printer-specific print driver is installed for this operating system as part of the software installation.	
Windows 10 server (Server 2016), 32-bit and 64-bit	The “HP PCL-6” printer-specific print driver is installed for this operating system as part of the software installation.	
OS X 10.11 El Capitan, macOS 10.12 Sierra, macOS 10.13 High Sierra	To install the print driver, download HP Easy Start from <a href="http://123.hp.com/LaserJet">123.hp.com/LaserJet</a> . Follow the steps provided to install the printer software and print driver.	

 **NOTE:** For a current list of supported operating systems, go to [www.hp.com/support/ljM118](http://www.hp.com/support/ljM118), [www.hp.com/support/ljM203](http://www.hp.com/support/ljM203) for HP's all-inclusive help for the printer.

 **NOTE:** For details on client and server operating systems and for HP UPD PCL6 and UPD PS driver support for this printer, go to [www.hp.com/go/upd](http://www.hp.com/go/upd) and click the **Specifications** tab.



## Mobile printing solutions

HP offers multiple mobile and ePrint solutions to enable easy printing to an HP printer from a laptop, tablet, smartphone, or other mobile device. To see the full list and to determine the best choice, go to [www.hp.com/go/LaserJetMobilePrinting](http://www.hp.com/go/LaserJetMobilePrinting).

 **NOTE:** Update the printer firmware to ensure all mobile printing and ePrint capabilities are supported.

- Wi-Fi Direct (wireless models only)
- HP ePrint via email (Requires HP Web Services to be enabled and the printer to be registered with HP Connected)
- HP ePrint app (Available for Android, iOS, and Blackberry)
- HP All-in-One Remote app for iOS and Android devices
- HP ePrint software
- Google Cloud Print
- AirPrint
- Android Printing

## Printer dimensions

Figure 1-1 Dimensions for the printer

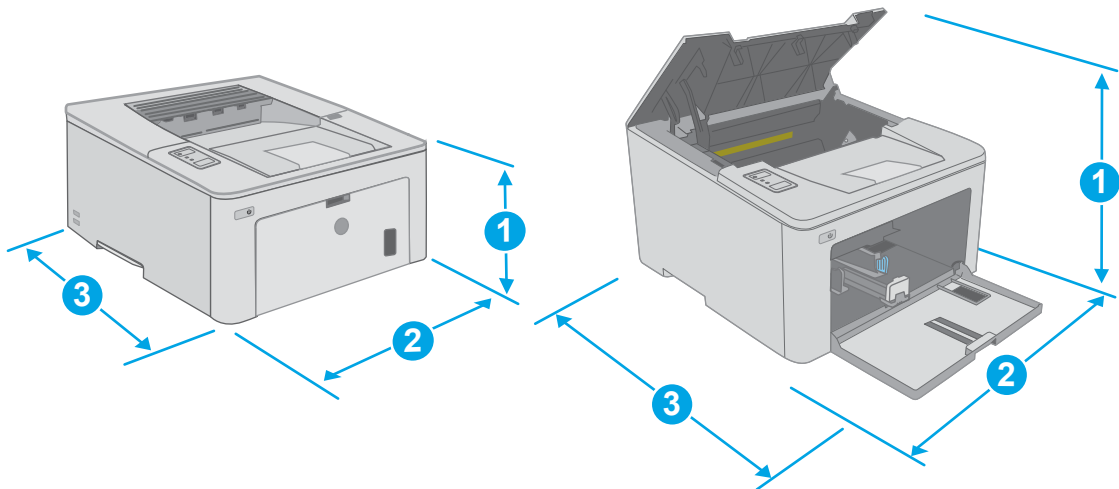

	Printer fully closed	Printer fully open
1. Height	223.9 mm (8.8 in)	359.5 mm (14.1 in)
2. Width	370.5 mm (14.5 in)	370.5 mm (14.5 in)
3. Depth	407.4 mm (16 in)	624.4 mm (24.6 in)
Weight (with cartridges)	6.9 kg (15.2 lb)	

## Power consumption, electrical specifications, and acoustic emissions

See [www.hp.com/support/ljM118](http://www.hp.com/support/ljM118), [www.hp.com/support/ljM203](http://www.hp.com/support/ljM203) for current information.

**⚠ CAUTION:** Power requirements are based on the country/region where the printer is sold. Do not convert operating voltages. This will damage the printer and void the printer warranty.

## Operating environmental range

Table 1-2 Operating environmental range

Environment	Recommended	Allowed
Temperature	17° to 25°C (62.6° to 77°F)	15° to 30°C (59° to 86°F)
Relative humidity	30% to 70% relative humidity (RH)	10% to 80% (RH)
Altitude	Not applicable	0 to 3048 m (0 to 10,000 ft)

## Printer hardware setup and software installation

For basic setup instructions, see the Setup Poster and Getting Started Guide that came with the printer. For additional instructions, go to HP support on the Web.

Go to [www.hp.com/support/ljM118](http://www.hp.com/support/ljM118), [www.hp.com/support/ljM203](http://www.hp.com/support/ljM203) for HP's all-inclusive help for the printer. Find the following support:

- Install and configure
- Learn and use
- Solve problems
- Download software and firmware updates
- Join support forums
- Find warranty and regulatory information



---

## 2 Paper trays

- [Load the Priority input tray](#)
- [Load the Main input tray](#)
- [Load and print envelopes](#)
- [Load and print labels](#)

### For more information:

The following information is correct at the time of publication. For current information, see [www.hp.com/support/ljM118](http://www.hp.com/support/ljM118), [www.hp.com/support/ljM203](http://www.hp.com/support/ljM203).

HP's all-inclusive help for the printer includes the following information:

- Install and configure
- Learn and use
- Solve problems
- Download software and firmware updates
- Join support forums
- Find warranty and regulatory information

# Load the Priority input tray

## Introduction

The following information describes how to load paper in the Priority input tray. This tray holds up to 10 sheets of 75 g/m<sup>2</sup> (20 lb) paper.

 **NOTE:** To avoid paper jams:

- Never add or remove paper from the Priority input tray during printing.
- Before loading the tray, remove all of the paper from the input tray and straighten the stack.
- When loading the tray, do not fan the paper.
- Use paper that is not wrinkled, folded, or damaged.

1. Open the Main input tray door by grasping the handle and pulling down.

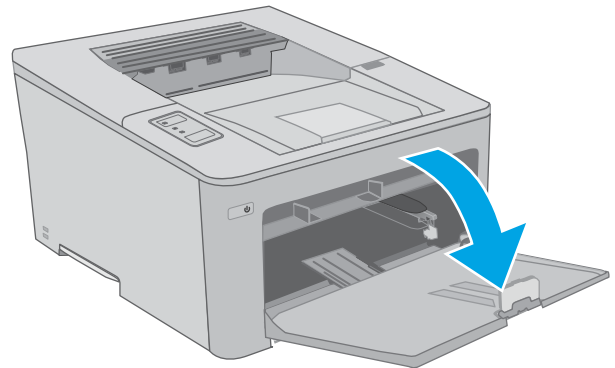

2. Spread the paper-width guides to the correct size.

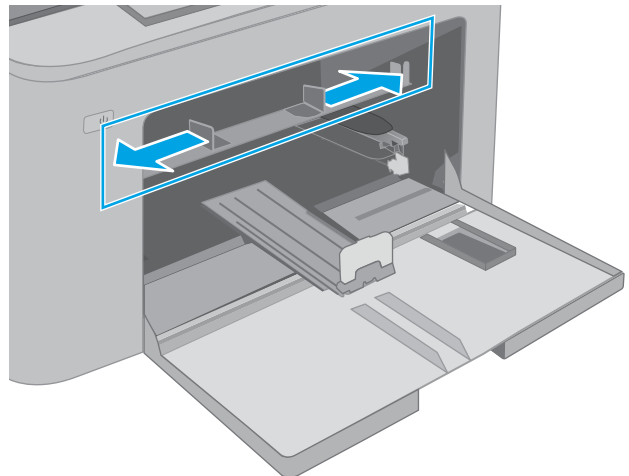

3. Place the top edge of the paper at the opening of the Priority input tray. For information about how to orient the paper, see [Priority input tray paper orientation on page 14](#).

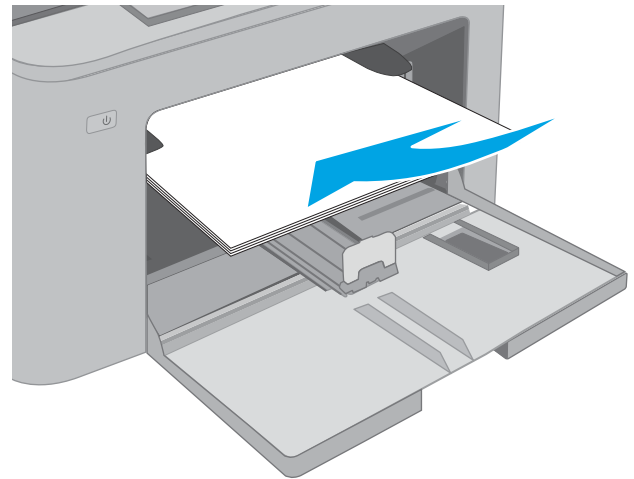

4. Adjust the paper guides so that they lightly touch the paper stack, but do not bend the paper.

**NOTE:** Do not adjust the paper guides tightly against the paper stack.

**NOTE:** To prevent jams, adjust the paper guides to the correct size and do not overfill the tray.

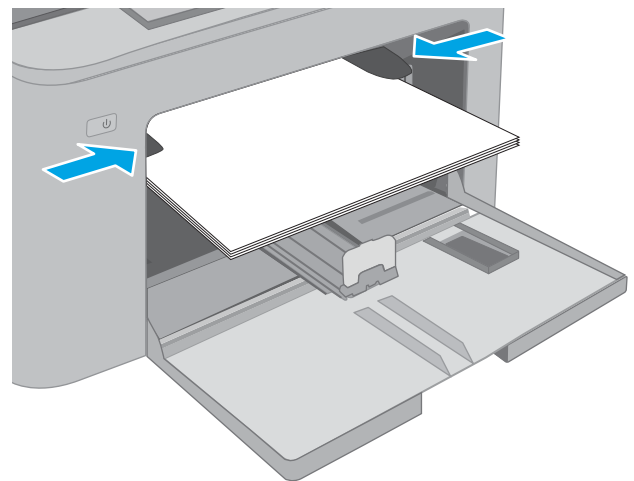

## Priority input tray paper orientation

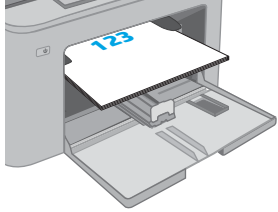
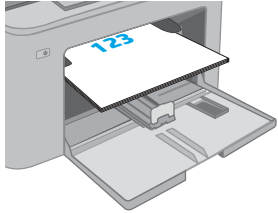
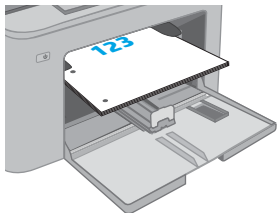
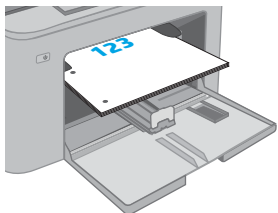
Paper type	Image orientation	Duplex mode	Paper size	How to load paper
Letterhead or Preprinted	Portrait	1-sided printing	Letter, Legal, Executive, Statement, Oficio (8.5 x 13), 4 x 6, 5 x 8, A4, A5, A6, RA5, B5 (JIS), B6 (JIS), 10 x 15 cm, Oficio (216 x 340), 16K 195 x 270 mm, 16K 184 x 260 mm, 16K 197 x 273 mm, Japanese Postcard (Postcard (JIS)), Double Japan Postcard Rotated (Double Postcard (JIS))	Face-up Top edge leading into the product 
		2-sided printing	Letter, Legal, Oficio (8.5 x 13), A4	Face-up Top edge leading into the product 
Prepunched	Portrait	1-sided printing	Letter, Legal, Executive, Statement, Oficio (8.5 x 13), 4 x 6, 5 x 8, A4, A5, A6, RA5, B5 (JIS), B6 (JIS), 10 x 15 cm, Oficio (216 x 340), 16K 195 x 270 mm, 16K 184 x 260 mm, 16K 197 x 273 mm, Japanese Postcard (Postcard (JIS)), Double Japan Postcard Rotated (Double Postcard (JIS))	Face-up Holes toward the left side of the product 
		2-sided printing	Letter, Legal, Oficio (8.5 x 13), A4	Face-up Holes toward the left side of the product 



# Load the Main input tray

## Introduction

The following information describes how to load paper in the Main input tray. This tray holds up to 250 sheets of 75 g/m<sup>2</sup> (20 lb) paper.

 **NOTE:** To avoid paper jams:

- Never add or remove paper from the Main input tray during printing.
- Before loading the tray, remove all of the paper from the input tray and straighten the stack.
- When loading the tray, do not fan the paper.
- Use paper that is not wrinkled, folded, or damaged.

1. Open the Main input tray door by grasping the handle and pulling down.

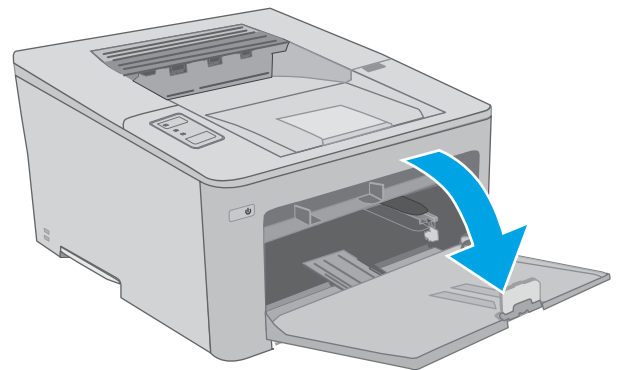

2. Adjust the paper-width guides by squeezing the adjustment latch on the right guide and sliding the guides to the size of the paper being used.

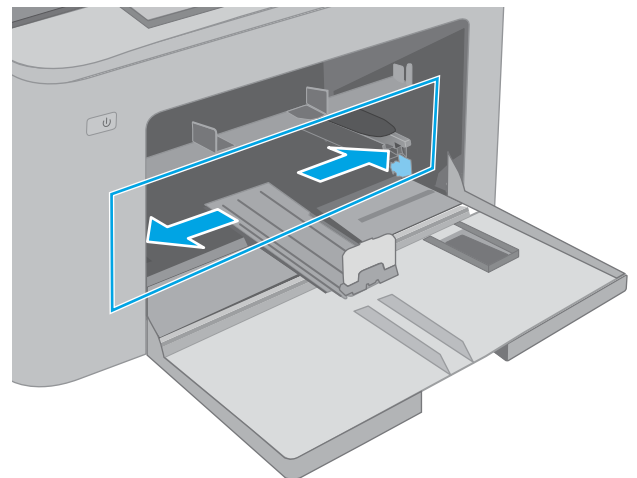

3. Adjust the paper-length guide by sliding guide to the size of the paper being used.

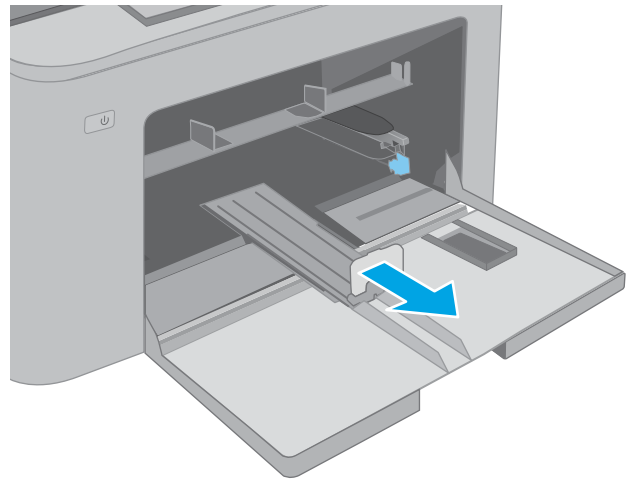

4. Load the paper into the tray. For information about how to orient the paper, see [Main input tray paper orientation on page 18](#).

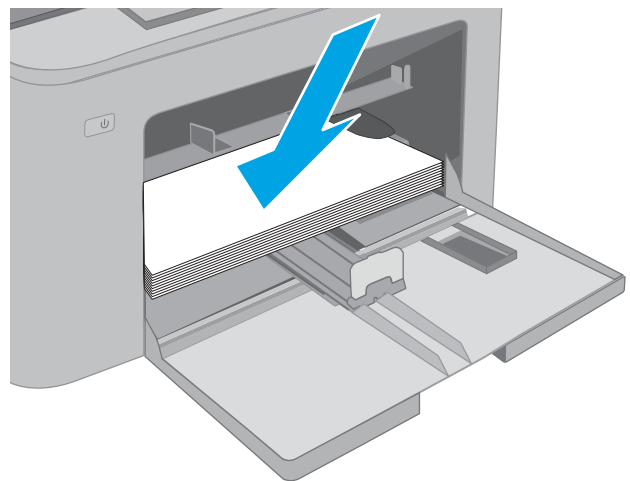

5. Adjust the guides so that they lightly touch the paper stack, but do not bend it.

**NOTE:** Do not adjust the paper guides tightly against the paper stack.

**NOTE:** To prevent jams, adjust the paper guides to the correct size and do not overfill the tray.

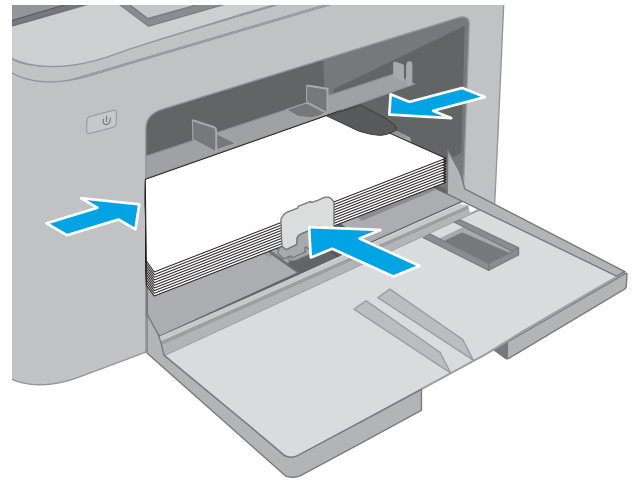

6. If the paper is A4 size, Letter-size, or smaller, close the Main input tray door. Use the paper-stack window to verify that is correctly loaded.

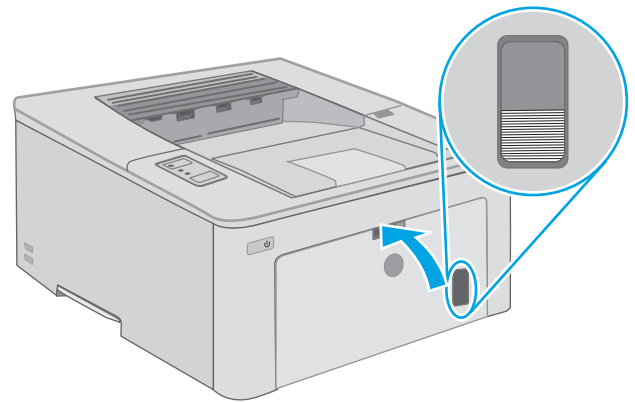

## Main input tray paper orientation

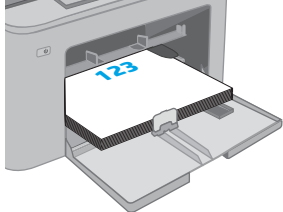
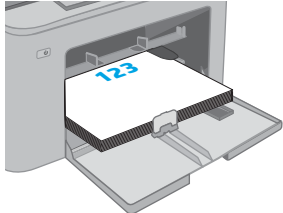
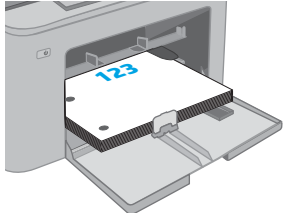
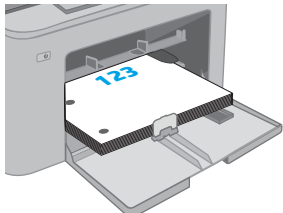
Paper type	Image orientation	Duplex mode	Paper size	How to load paper
Letterhead or preprinted	Portrait	1-sided printing	Letter, Legal, Executive, Statement, Oficio (8.5 x 13), 4 x 6, 5 x 8, A4, A5, A6, RA5, B5 (JIS), B6 (JIS), 10 x 15 cm, Oficio (216 x 340), 16K 195 x 270 mm, 16K 184 x 260 mm, 16K 197 x 273 mm, Japanese Postcard (Postcard (JIS)), Double Japan Postcard Rotated (Double Postcard (JIS))	Face-up Top edge leading into the product 
		2-sided printing	Letter, Legal, Oficio (8.5 x 13), A4	Face-up Top edge leading into the product 
Punchpunched	Portrait	1-sided printing	Letter, Legal, Executive, Statement, Oficio (8.5 x 13), 4 x 6, 5 x 8, A4, A5, A6, RA5, B5 (JIS), B6 (JIS), 10 x 15 cm, Oficio (216 x 340), 16K 195 x 270 mm, 16K 184 x 260 mm, 16K 197 x 273 mm, Japanese Postcard (Postcard (JIS)), Double Japan Postcard Rotated (Double Postcard (JIS))	Face-up Holes toward the left side of the product 
		2-sided printing	Letter, Legal, Oficio (8.5 x 13), A4	Face-up Holes toward the left side of the product 

# Load and print envelopes

## Introduction

The following information describes how to print and load envelopes. The Priority input tray holds up to 10 envelopes. The Main input tray holds up to 10 envelopes.

To print envelopes using the manual feed option, follow these steps to select the correct settings in the print driver, and then load the envelopes into the tray after sending the print job to the printer.

## Print envelopes

1. From the software program, select the **Print** option.
2. Select the printer from the list of printers, and then click or tap the **Properties** or **Preferences** button to open the print driver.

---

 **NOTE:** The name of the button varies for different software programs.

 **NOTE:** To access these features from a Windows 8 or 8.1 Start screen, select **Devices**, select **Print**, and then select the printer. For Windows 10, select **Print**, which can vary depending on the application. For Windows 8, 8.1, and 10, these applications will have a different layout with different features than what is described below for desktop applications.

---

3. Click or tap the **Paper/Quality** tab.
4. In the **Paper size** drop-down list, select the correct size for the envelopes.
5. In the **Paper type** drop-down list, select **Envelope**.
6. In the **Paper source** drop-down list, select **Manual feed**.
7. Click the **OK** button to close the **Document Properties** dialog box.
8. In the **Print** dialog box, click the **OK** button to print the job.

## Envelope orientation

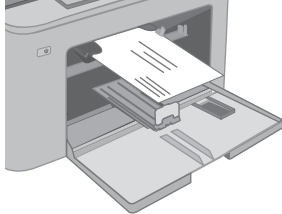
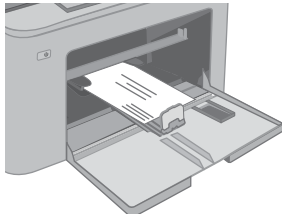
Tray	Envelope size	How to load envelopes
Priority input tray	Envelope #10, Envelope Monarch, Envelope B5, Envelope C5, Envelope DL	Face up Short, postage end leading into the printer 
Main input tray	Envelope #10, Envelope Monarch, Envelope B5, Envelope C5, Envelope DL	Face up Short, postage end leading into the printer 

# Load and print labels

## Introduction

The following information describes how to print and load labels.

To print labels using the manual feed option, follow these steps to select the correct settings in the print driver, and then load the labels into the tray after sending the print job to the printer. When using manual feed, the printer waits to print the job until it detects that the tray has been opened.

## Manually feed labels

1. From the software program, select the **Print** option.
2. Select the printer from the list of printers, and then click or tap the **Properties** or **Preferences** button to open the print driver.

---

 **NOTE:** The name of the button varies for different software programs.

 **NOTE:** To access these features from a Windows 8 or 8.1 Start screen, select **Devices**, select **Print**, and then select the printer. For Windows 10, select **Print**, which can vary depending on the application. For Windows 8, 8.1, and 10, these applications will have a different layout with different features than what is described below for desktop applications.

---

3. Click the **Paper/Quality** tab.
4. In the **Paper size** drop-down list, select the correct size for the sheets of labels.
5. In the **Paper type** drop-down list, select **Labels**.
6. In the **Paper source** drop-down list, select **Manual feed**.
7. Click the **OK** button to close the **Document Properties** dialog box.
8. In the **Print** dialog box, click the **OK** button to print the job.

## Label orientation

---

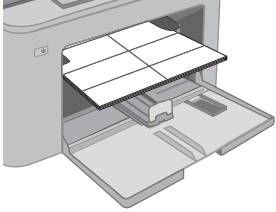
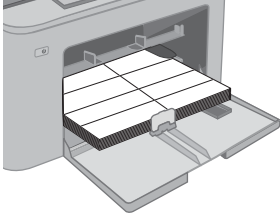
Tray	How to load labels
Priority input tray	Face-up Top edge leading into the printer
	
Main input tray	Face-up Top edge leading into the printer
	

---



---

## 3 Supplies, accessories, and parts

- [Order supplies, accessories, and parts](#)
- [Configure the HP toner-cartridge-protection supply settings](#)
- [Replace the toner cartridge](#)
- [Replace the imaging drum](#)

### For more information:

The following information is correct at the time of publication. For current information, see [www.hp.com/support/ljM118](http://www.hp.com/support/ljM118), [www.hp.com/support/ljM203](http://www.hp.com/support/ljM203).

HP's all-inclusive help for the printer includes the following information:

- Install and configure
- Learn and use
- Solve problems
- Download software and firmware updates
- Join support forums
- Find warranty and regulatory information

# Order supplies, accessories, and parts

## Ordering

Order supplies and paper	<a href="http://www.hp.com/go/suresupply">www.hp.com/go/suresupply</a>
Order genuine HP parts or accessories	<a href="http://www.hp.com/buy/parts">www.hp.com/buy/parts</a>
Order through service or support providers	Contact an HP-authorized service or support provider.
Order using the HP Embedded Web Server (EWS)	To access, in a supported Web browser on the computer, enter the printer IP address or host name in the address/URL field. The EWS contains a link to the HP SureSupply Web site, which provides options for purchasing Original HP supplies.

## Supplies and accessories

Item	Description	Cartridge number	Part number
<b>Supplies</b>			
HP 30A Black LaserJet Toner Cartridge	Standard-capacity replacement black toner cartridge	30A	CF230A
HP 30X Black LaserJet Toner Cartridge	High-capacity replacement black toner cartridge	30X	CF230X
HP 31A Black LaserJet Toner Cartridge	Standard-capacity replacement black toner cartridge	31A	CF231A
HP 94A Black LaserJet Toner Cartridge	Standard-capacity replacement black toner cartridge (M118dw model only)	94A	CF294A
HP 94X Black LaserJet Toner Cartridge	High-capacity replacement black toner cartridge (M118dw model only)	94X	CF294X
HP 32A Original LaserJet Imaging Drum	Imaging drum	32A	CF232A

# Configure the HP toner-cartridge-protection supply settings

- [Introduction](#)
- [Enable or disable the Cartridge Policy feature](#)
- [Enable or disable the Cartridge Protection feature](#)

## Introduction

Use HP Cartridge Policy and Cartridge Protection to control which cartridges are installed in the printer and protect the cartridges that are installed from theft.

- **Cartridge Policy:** This feature protects the printer from counterfeit toner cartridges by allowing only genuine HP cartridges to be used with the printer. Using genuine HP cartridges ensures the best possible print quality. When someone installs a cartridge that is not a genuine HP cartridge, the printer control panel displays a message that the cartridge is unauthorized and it provides information explaining how to proceed.
- **Cartridge Protection:** This feature permanently associates toner cartridges with a specific printer, or fleet of printers, so they cannot be used in other printers. Protecting cartridges protects your investment. When this feature is enabled, if someone attempts to transfer a protected cartridge from the original printer into an unauthorized printer, that printer will not print with the protected cartridge. The printer control panel displays a message that the cartridge is protected, and it provides information explaining how to proceed.



**⚠ CAUTION:** After enabling cartridge protection for the printer, all subsequent toner cartridges installed in the printer are automatically and *permanently* protected. To avoid protecting a new cartridge, disable the feature *before* installing the new cartridge.

Turning the feature off does not turn off protection for cartridges that are currently installed.

Both features are off by default. Follow these procedures to enable or disable them.

## Enable or disable the Cartridge Policy feature

### Use the HP Embedded Web Server (EWS) to enable the Cartridge Policy feature

1. Open the HP EWS.
  - a. Print a configuration page to determine the IP address or host name.
    - i. Press and hold the Resume  button until the Ready  light begins blinking.
    - ii. Release the Resume  button.
  - b. Open a web browser, and in the address line, type the IP address or host name exactly as it displays on the printer control panel. Press the **Enter** key on the computer keyboard. The EWS opens.



 <https://10.10.XXXXX/>

**📝 NOTE:** If the displays a message indicating that accessing the website might not be safe, select the option to continue to the website. Accessing this website will not harm the computer.

2. Click the **System** tab.

3. From the left navigation pane, select **Supply Settings**.
4. From the **Cartridge Policy** drop-down list, select **Authorized HP**.
5. Click the **Apply** button.

## Use the HP Embedded Web Server (EWS) to disable the Cartridge Policy feature

1. Open the HP EWS.
  - a. Print a configuration page to determine the IP address or host name.
    - i. Press and hold the Resume  button until the Ready  light begins blinking.
    - ii. Release the Resume  button.
  - b. Open a web browser, and in the address line, type the IP address or host name exactly as it displays on the printer control panel. Press the **Enter** key on the computer keyboard. The EWS opens.

 <https://10.10.XX.XXX/>

 **NOTE:** If the displays a message indicating that accessing the website might not be safe, select the option to continue to the website. Accessing this website will not harm the computer.



2. Click the **System** tab.
3. From the left navigation pane, select **Supply Settings**.
4. From the **Cartridge Policy** drop-down menu, select **Off**.
5. Click the **Apply** button.

## Troubleshoot Cartridge Policy control panel error messages

Error message	Description	Recommended action
10.30.0X Unauthorized <Color> Cartridge	The administrator has configured this printer to use only genuine HP supplies that are still under warranty. The cartridge must be replaced to continue printing.	<p>Replace the cartridge with a genuine HP toner cartridge.</p> <p>If you believe you purchased a genuine HP supply, visit <a href="http://www.hp.com/go/anticounterfeit">www.hp.com/go/anticounterfeit</a> to determine if the toner cartridge is a genuine HP cartridge, and learn what to do if it is not a genuine HP cartridge.</p>

## Enable or disable the Cartridge Protection feature

### Use the HP Embedded Web Server (EWS) to enable the Cartridge Protection feature

1. Open the HP EWS.
  - a. Print a configuration page to determine the IP address or host name.
    - i. Press and hold the Resume  button until the Ready  light begins blinking.
    - ii. Release the Resume  button.
  - b. Open a web browser, and in the address line, type the IP address or host name exactly as it displays on the printer control panel. Press the **Enter** key on the computer keyboard. The EWS opens.

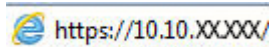



 **NOTE:** If the displays a message indicating that accessing the website might not be safe, select the option to continue to the website. Accessing this website will not harm the computer.

2. Click the **System** tab.
3. From the left navigation pane, select **Supply Settings**.
4. From the **Cartridge Protection** drop-down list, select **Protect Cartridges**.
5. Click the **Apply** button.

 **CAUTION:** After enabling cartridge protection for the printer, all subsequent toner cartridges installed in the printer are automatically and *permanently* protected. To avoid protecting a new cartridge, disable the Cartridge Protection feature *before* installing the new cartridge.

Turning the feature off does not turn off protection for cartridges that are currently installed.

### Use the HP Embedded Web Server (EWS) to disable the Cartridge Protection feature

1. Open the HP EWS.
  - a. Print a configuration page to determine the IP address or host name.
    - i. Press and hold the Resume  button until the Ready  light begins blinking.
    - ii. Release the Resume  button.
  - b. Open a web browser, and in the address line, type the IP address or host name exactly as it displays on the printer control panel. Press the **Enter** key on the computer keyboard. The EWS opens.

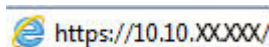

 **NOTE:** If the displays a message indicating that accessing the website might not be safe, select the option to continue to the website. Accessing this website will not harm the computer.

2. Click the **System** tab.
3. From the left navigation pane, select **Supply Settings**.

4. From the **Cartridge Protection** drop-down list, select **Off**.
5. Click the **Apply** button.

## Troubleshoot Cartridge Protection control panel error messages

Error message	Description	Recommended action
10.57.0X Protected <Color> Cartridge	<p>The cartridge can only be used in the printer or fleet of printers that initially protected it using HP Cartridge Protection.</p> <p>The Cartridge Protection feature allows an administrator to restrict cartridges to work in only one printer or fleet of printers. The cartridge must be replaced to continue printing.</p>	Replace the cartridge with a new toner cartridge.

# Replace the toner cartridge

- [Introduction](#)
- [Toner-cartridge information](#)
- [Remove and replace the toner cartridge](#)

## Introduction

The following information provides details about the toner cartridge for the printer, and it includes instructions to replace it.

## Toner-cartridge information

This printer indicates when the toner cartridge level is low. The actual toner cartridge life remaining can vary. Consider having a replacement cartridge available to install when print quality is no longer acceptable.

To purchase cartridges or check cartridge compatibility for the printer, go to HP SureSupply at [www.hp.com/go/suresupply](http://www.hp.com/go/suresupply). Scroll to the bottom of the page and verify that the country/region is correct.

Item	Description	Cartridge number	Part number
HP 30A Black LaserJet Toner Cartridge	Standard-capacity replacement black toner cartridge	30A	CF230A
HP 30X Black LaserJet Toner Cartridge	High-capacity replacement black toner cartridge	30X	CF230X
HP 31A Black LaserJet Toner Cartridge	Standard-capacity replacement black toner cartridge	31A	CF231A
HP 94A Black LaserJet Toner Cartridge	Standard-capacity replacement black toner cartridge (M118dw model only)	94A	CF294A
HP 94X Black LaserJet Toner Cartridge	High-capacity replacement black toner cartridge (M118dw model only)	94X	CF294X

 **NOTE:** High-yield toner cartridges contain more toner than standard cartridges for increased page yield. For more information, go to [www.hp.com/go/learnaboutsupplies](http://www.hp.com/go/learnaboutsupplies).

Do not remove the toner cartridge from its package until it is time to replace it.

 **CAUTION:** To prevent damage to the toner cartridge, do not expose it to light for more than a few minutes.

The following illustration shows the toner-cartridge components.

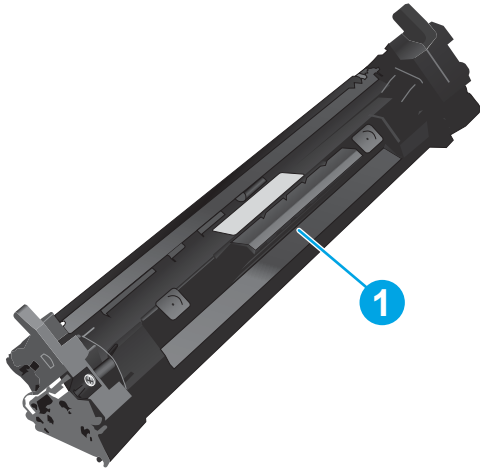

---

1 Toner cartridge

---

**CAUTION:** If toner gets on clothing, wipe it off by using a dry cloth and wash the clothes in cold water. Hot water sets toner into fabric.

**NOTE:** Information about recycling used toner cartridges is in the toner-cartridge box.

---

## Remove and replace the toner cartridge

1. Open the cartridge door.

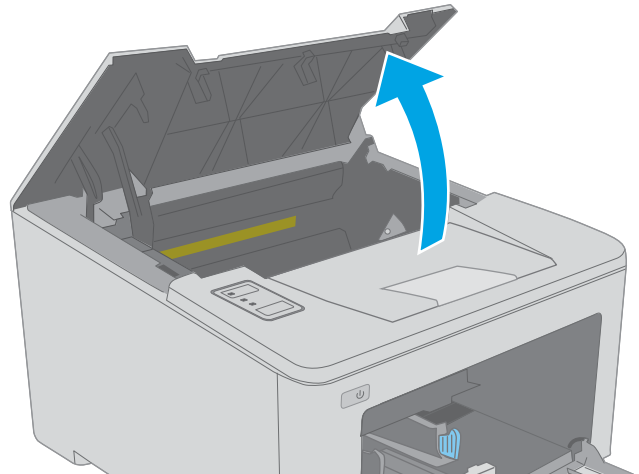



2. Remove the used toner cartridge from the printer.

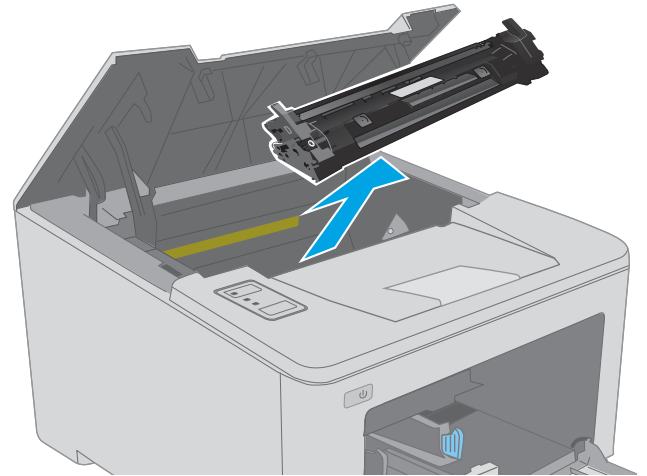

3. Remove the new toner-cartridge package from the box, and then pull the release tab on the packaging.

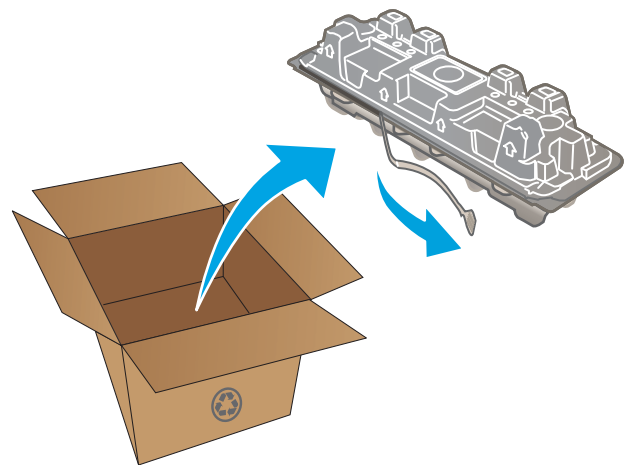

4. Remove the new toner cartridge from the opened packaging shell. Place the used toner cartridge in the shell for recycling.

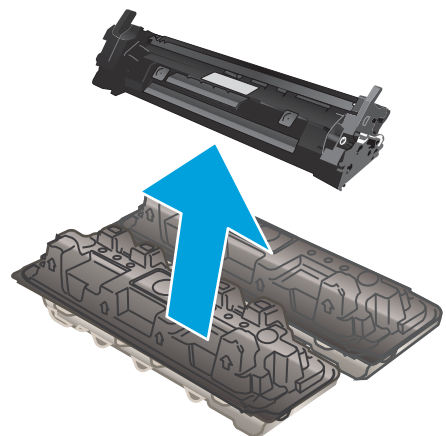

5. Align the new toner cartridge with the tracks inside the printer, and install the new toner cartridge until it is firmly seated.

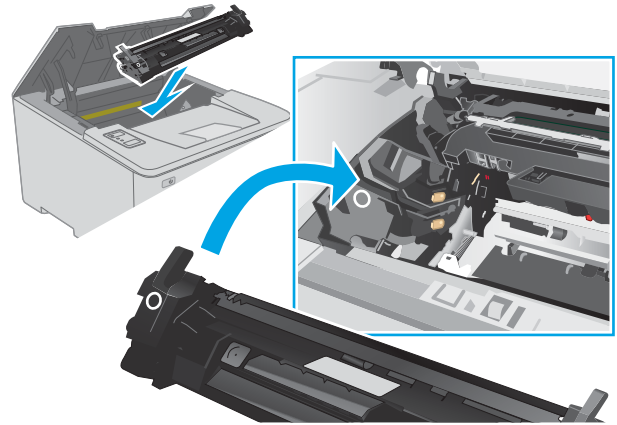

6. Close the cartridge door.

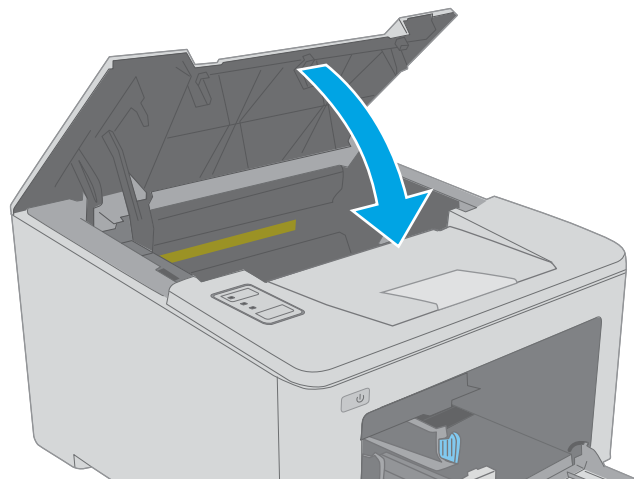

# Replace the imaging drum

- [Introduction](#)
- [Imaging drum information](#)
- [Remove and replace the imaging drum](#)

## Introduction

The following information provides details about the imaging drum for the printer, and it includes instructions to replace it.

## Imaging drum information

This printer indicates when the imaging drum needs to be replaced. The actual imaging drum life remaining can vary. Consider having a replacement imaging drum available to install when print quality is no longer acceptable.

To purchase imaging drums for the printer, go to HP SureSupply at [www.hp.com/go/suresupply](http://www.hp.com/go/suresupply). Scroll to the bottom of the page and verify that the country/region is correct.

Item	Description	Cartridge number	Part number
HP 32A Original LaserJet Imaging Drum	Replacement imaging drum	32A	CF232A

Do not remove the imaging drum from its package until it is time to replace it.

**CAUTION:** To prevent damage to the imaging drum, do not expose it to light for more than a few minutes. Cover the imaging drum if it must be removed from the printer for an extended period of time.

The following illustration shows the imaging-drum components.

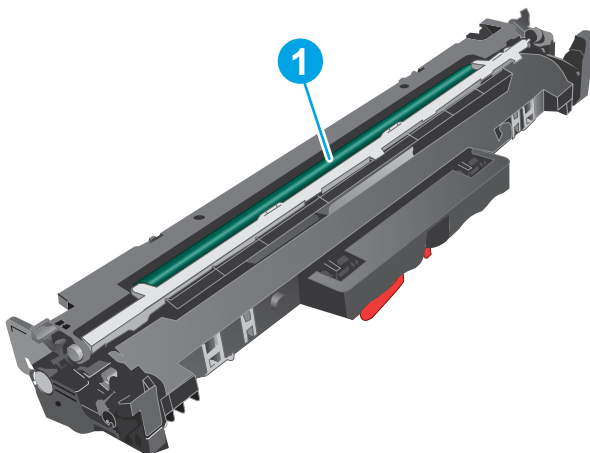

1 Imaging drum

**CAUTION:** Do not touch the imaging drum. Fingerprints can cause print-quality problems.

Information about recycling used imaging drums is in the imaging-drum box.

## Remove and replace the imaging drum

1. Open the cartridge door.

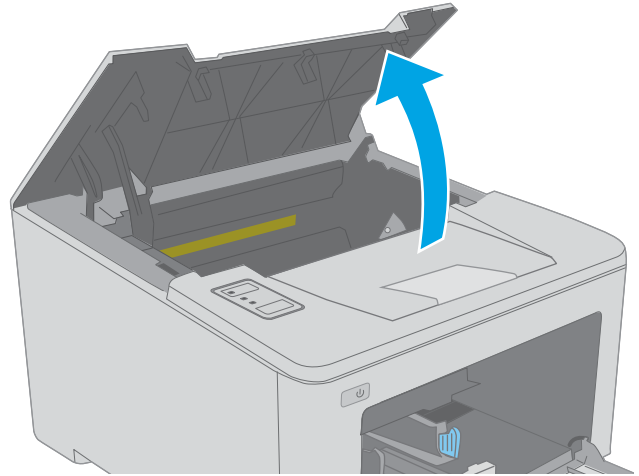

2. Temporarily remove the toner cartridge from the printer.

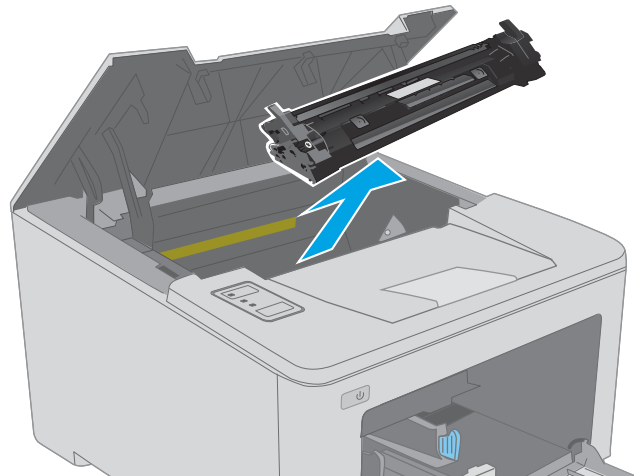

3. Remove the used imaging drum from the printer.

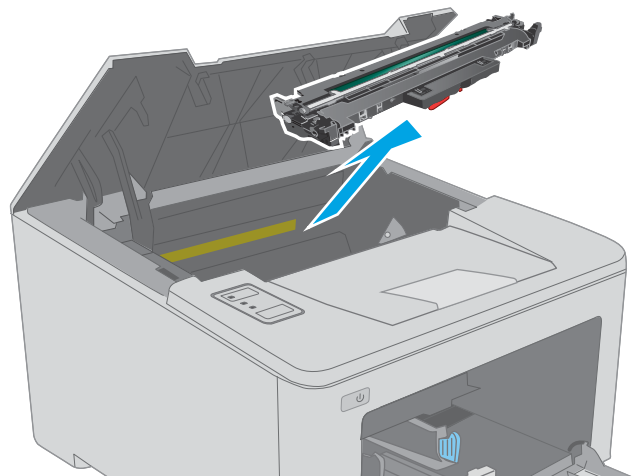

4. Remove the new imaging drum package from the box, and then release the packaging.

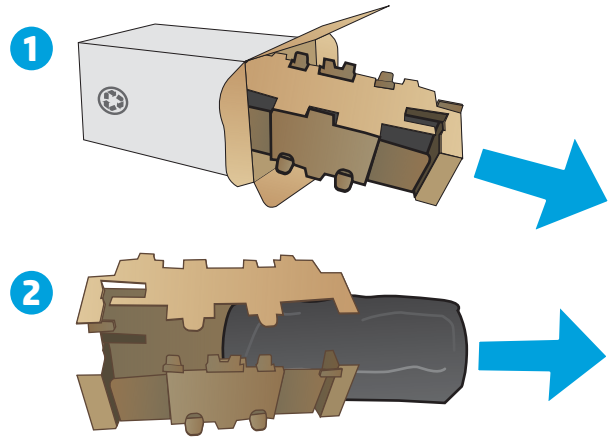

5. Remove the new imaging-drum package from the package.

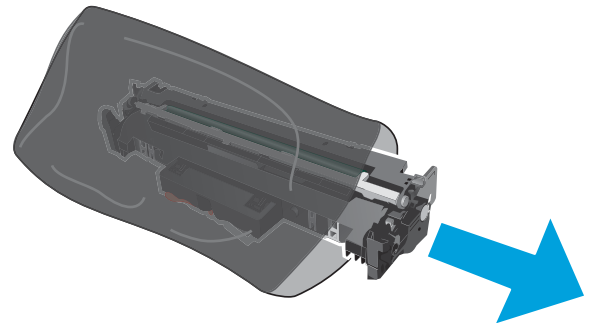

6. Do not touch the imaging drum. Fingerprints on the imaging drum can cause print-quality problems.

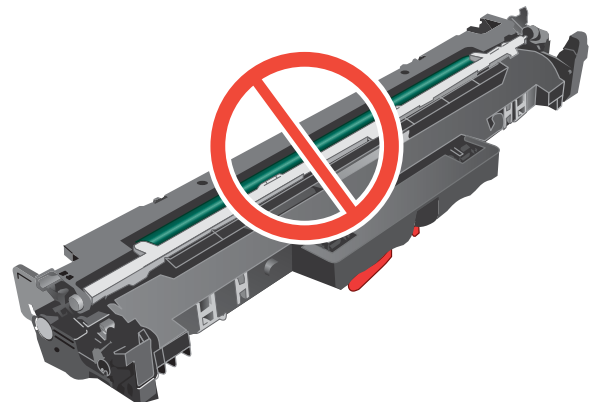

7. Align the new image drum with the tracks inside the printer, and install the new image drum until it is firmly seated.

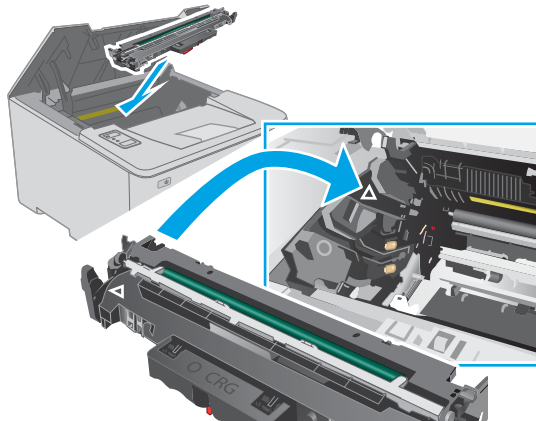

8. Align the toner cartridge with the tracks inside the printer, and install the toner cartridge until it is firmly seated.

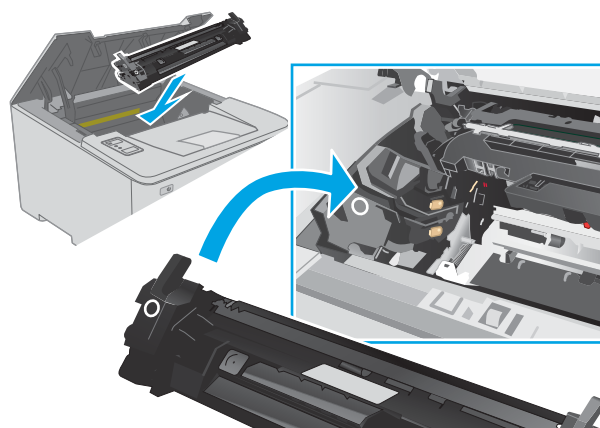

9. Close the cartridge door.

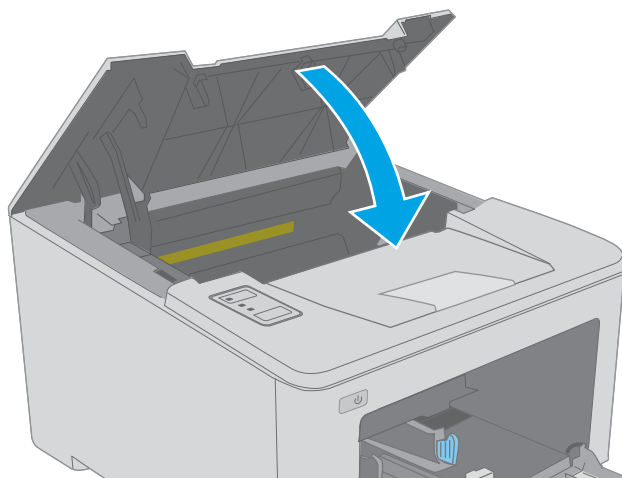

---

# 4 Print

- [Print tasks \(Windows\)](#)
- [Print tasks \(OS X\)](#)
- [Mobile printing](#)

## For more information:

The following information is correct at the time of publication. For current information, see [www.hp.com/support/ljM118](http://www.hp.com/support/ljM118), [www.hp.com/support/ljM203](http://www.hp.com/support/ljM203).

HP's all-inclusive help for the printer includes the following information:

- Install and configure
- Learn and use
- Solve problems
- Download software and firmware updates
- Join support forums
- Find warranty and regulatory information

# Print tasks (Windows)

## How to print (Windows)

The following procedure describes the basic printing process for Windows.

1. From the software program, select the **Print** option.
2. Select the printer from the list of printers. To change settings, click the **Properties** or **Preferences** button to open the print driver.

---

 **NOTE:** The name of the button varies for different software programs.

 **NOTE:** In Windows 10, 8.1, and 8, these applications will have a different layout with different features from what is described below for desktop applications. To access the print feature from a Start screen app, complete the following steps:

- **Windows 10:** Select **Print**, and then select the printer.
- **Windows 8.1 or 8:** Select **Devices**, select **Print**, and then select the printer.

---

 **NOTE:** For more information, click the Help (?) button in the print driver.

3. Click the tabs in the print driver to configure the available options. For example, set the paper orientation on the **Finishing** tab, and set the paper source, paper type, paper size, and quality settings on the **Paper/Quality** tab.
4. Click the **OK** button to return to the **Print** dialog box. Select the number of copies to print from this screen.
5. Click the **Print** button to print the job.

## Automatically print on both sides (Windows)

Use this procedure for printers that have an automatic duplexer installed. If the printer does not have an automatic duplexer installed, or to print on paper types that the duplexer does not support, print on both sides manually.

1. From the software program, select the **Print** option.
2. Select the printer from the list of printers, and then click the **Properties** or **Preferences** button to open the print driver.

---

 **NOTE:** The name of the button varies for different software programs.

 **NOTE:** In Windows 10, 8.1, and 8, these applications will have a different layout with different features from what is described below for desktop applications. To access the print feature from a Start screen app, complete the following steps:

- **Windows 10:** Select **Print**, and then select the printer.
- **Windows 8.1 or 8:** Select **Devices**, select **Print**, and then select the printer.

- 
3. Click the **Finishing** tab.
  4. Select **Print on both sides**. Click **OK** to close the **Document Properties** dialog.
  5. In the **Print** dialog, click **Print** to print the job.



## Manually print on both sides (Windows)

Use this procedure for printers that do not have an automatic duplexer installed or to print on paper that the duplexer does not support.

1. From the software program, select the **Print** option.
2. Select the printer from the list of printers, and then click the **Properties** or **Preferences** button to open the print driver.

---

 **NOTE:** The name of the button varies for different software programs.

 **NOTE:** In Windows 10, 8.1, and 8, these applications will have a different layout with different features from what is described below for desktop applications. To access the print feature from a Start screen app, complete the following steps:

- **Windows 10:** Select **Print**, and then select the printer.
  - **Windows 8.1 or 8:** Select **Devices**, select **Print**, and then select the printer.
- 

3. Click the **Finishing** tab.
4. Select **Print on both sides (manually)**, and then click **OK** to close the **Document Properties** dialog.
5. In the **Print** dialog, click **Print** to print the first side of the job.
6. Retrieve the printed stack from the output bin, and place it in Tray 1.
7. If prompted, select the appropriate control panel button to continue.

## Print multiple pages per sheet (Windows)

1. From the software program, select the **Print** option.
2. Select the printer from the list of printers, and then click the **Properties** or **Preferences** button to open the print driver.

---

 **NOTE:** The name of the button varies for different software programs.

 **NOTE:** In Windows 10, 8.1, and 8, these applications will have a different layout with different features from what is described below for desktop applications. To access the print feature from a Start screen app, complete the following steps:

- **Windows 10:** Select **Print**, and then select the printer.
  - **Windows 8.1 or 8:** Select **Devices**, select **Print**, and then select the printer.
- 

3. Click the **Finishing** tab.
4. Select the number of pages per sheet from the **Pages per sheet** drop-down list.
5. Select the correct **Print page borders**, **Page order**, and **Orientation** options. Click **OK** to close the **Document Properties** dialog.
6. In the **Print** dialog, click **Print** to print the job.

## Select the paper type (Windows)

1. From the software program, select the **Print** option.
2. Select the printer from the list of printers, and then click the **Properties** or **Preferences** button to open the print driver.

---

 **NOTE:** The name of the button varies for different software programs.

 **NOTE:** In Windows 10, 8.1, and 8, these applications will have a different layout with different features from what is described below for desktop applications. To access the print feature from a Start screen app, complete the following steps:

- **Windows 10:** Select **Print**, and then select the printer.
  - **Windows 8.1 or 8:** Select **Devices**, select **Print**, and then select the printer.
- 

3. Click the **Paper/Quality** tab.
4. Select the paper type from the **Paper type** drop-down list.
5. Click **OK** to close the **Document Properties** dialog. In the **Print** dialog, click **Print** to print the job.  
If the tray needs to be configured, a tray configuration message displays on the printer control panel.
6. Load the tray with the specified type and size of paper, and then close the tray.
7. Select the **OK** button to accept the detected type and size, or select the **Modify** button to choose a different paper size or type.
8. Select the correct type and size, and then select the **OK** button.

## Additional print tasks

Go to [www.hp.com/support/ljM118](http://www.hp.com/support/ljM118), [www.hp.com/support/ljM203](http://www.hp.com/support/ljM203).

Instructions are available for performing specific print tasks, such as the following:

- Create and use printing shortcuts or presets
- Select the paper size, or use a custom paper size
- Select the page orientation
- Create a booklet
- Scale a document to fit a specific paper size
- Print the first or last pages of the document on different paper
- Print watermarks on a document

# Print tasks (OS X)

## How to print (OS X)

The following procedure describes the basic printing process for OS X.

1. Click the **File** menu, and then click the **Print** option.
2. Select the printer.
3. Click **Show Details** or **Copies & Pages**, and then select other menus to adjust the print settings.

---

 **NOTE:** The name of the item varies for different software programs.

---

4. Click the **Print** button.

## Automatically print on both sides (OS X)

---

 **NOTE:** This information applies to printers that include an automatic duplexer.

 **NOTE:** This feature is available if you install the HP print driver. It might not be available if you are using AirPrint.

---

1. Click the **File** menu, and then click the **Print** option.
2. Select the printer.
3. Click **Show Details** or **Copies & Pages**, and then click the **Layout** menu.

---

 **NOTE:** The name of the item varies for different software programs.

---

4. Select a binding option from the **Two-Sided** drop-down list.
5. Click the **Print** button.

## Manually print on both sides (OS X)

---

 **NOTE:** This feature is available if you install the HP print driver. It might not be available if you are using AirPrint.

---

1. Click the **File** menu, and then click the **Print** option.
2. Select the printer.
3. Click **Show Details** or **Copies & Pages**, and then click the **Manual Duplex** menu.

---

 **NOTE:** The name of the item varies for different software programs.

---

4. Click the **Manual Duplex** box, and select a binding option.
5. Click the **Print** button.
6. Go to the printer, and remove any blank paper that is in Tray 1.
7. Retrieve the printed stack from the output bin and place it with the printed-side facing down in the input tray.
8. If prompted, touch the appropriate control panel button to continue.

## Print multiple pages per sheet (OS X)

1. Click the **File** menu, and then click the **Print** option.
2. Select the printer.
3. Click **Show Details** or **Copies & Pages**, and then click the **Layout** menu.



---

**NOTE:** The name of the item varies for different software programs.

---

4. From the **Pages per Sheet** drop-down list, select the number of pages that you want to print on each sheet.
5. In the **Layout Direction** area, select the order and placement of the pages on the sheet.
6. From the **Borders** menu, select the type of border to print around each page on the sheet.
7. Click the **Print** button.

## Select the paper type (OS X)

1. Click the **File** menu, and then click the **Print** option.
2. Select the printer.
3. Click **Show Details** or **Copies & Pages**, and then click the **Media & Quality** menu or the **Paper/Quality** menu.



---

**NOTE:** The name of the item varies for different software programs.

---

4. Select from the **Media & Quality** or **Paper/Quality** options.



---

**NOTE:** This list contains the master set of options available. Some options are not available on all printers.

---

- **Media Type:** Select the option for the type of paper for the print job.
  - **Print Quality:** Select the resolution level for the print job.
  - **Edge-To-Edge Printing:** Select this option to print close to the paper edges.
  - **EconoMode:** Select this option to conserve toner when printing drafts of documents.
5. Click the **Print** button.

## Additional print tasks

Go to [www.hp.com/support/ljM118](http://www.hp.com/support/ljM118), [www.hp.com/support/ljM203](http://www.hp.com/support/ljM203).

Instructions are available for performing specific print tasks, such as the following:

- Create and use printing shortcuts or presets
- Select the paper size, or use a custom paper size
- Select the page orientation
- Create a booklet
- Scale a document to fit a specific paper size
- Print the first or last pages of the document on different paper
- Print watermarks on a document

# Mobile printing

## Introduction

HP offers multiple mobile and ePrint solutions to enable easy printing to an HP printer from a laptop, tablet, smartphone, or other mobile device. To see the full list and to determine the best choice, go to [www.hp.com/go/LaserJetMobilePrinting](http://www.hp.com/go/LaserJetMobilePrinting).

---

 **NOTE:** Update the printer firmware to ensure all mobile printing and ePrint capabilities are supported.

---

- [Wi-Fi Direct \(wireless models only\)](#)
- [HP ePrint via email](#)
- [HP ePrint software](#)
- [AirPrint](#)
- [Android embedded printing](#)

## Wi-Fi Direct (wireless models only)

Wi-Fi Direct enables printing from a wireless mobile device without requiring a connection to a network or the Internet.



Wi-Fi Direct does not support all mobile operating systems. If the mobile device does not support Wi-Fi Direct, you must change the wireless network connection of the device to the Wi-Fi Direct connection of the printer before printing.

---

 **NOTE:** For non-Wi-Fi Direct capable mobile devices, the Wi-Fi Direct connection only enables printing. After using Wi-Fi Direct to print, you must reconnect to a local network in order to access the Internet.

---

To access the printer Wi-Fi Direct connection, complete the following steps:

1. Print a configuration page to determine the IP address or host name.
  - a. Press and hold the Resume  button until the Ready  light begins blinking.
  - b. Release the Resume  button.
2. Open a web browser, and in the address line, type the IP address or host name exactly as it displays on the printer configuration page. Press the **Enter** key on the computer keyboard. The EWS opens.

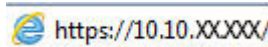

---

 **NOTE:** If the web browser displays a message indicating that accessing the website might not be safe, select the option to continue to the website. Accessing this website will not harm the computer.

---

3. On the **Networking** tab, click the **Wi-Fi Direct Setup** link in the left navigation pane.
4. Choose one of the following connection methods:
  - **Manual**
  - **Advanced**

5. On the mobile device, open the **Wi-Fi** or the **Wi-Fi Direct** menu.
6. From the list of available networks, select the printer name.

---

 **NOTE:** If the printer name does not display, you might be out of range of the Wi-Fi Direct signal. Move the device closer to the printer.

---

7. If prompted, enter the Wi-Fi Direct password.

---

 **NOTE:** For Android devices that support Wi-Fi Direct, if the connection method is set to **Automatic**, the connection will occur automatically, without a password prompt. If the connection method is set to **Manual**, you will need to either press the **OK** button, or provide a personal identification number (PIN) — displayed on the configuration report — as a password on the mobile device.

---

 **NOTE:** To access the Wi-Fi Direct password, from the EWS open the **Networking** tab, and then click **Wi-Fi Direct Setup**.

---

8. Open the document, and then select the **Print** option.

---

 **NOTE:** If the mobile device does not support printing, install the HP ePrint mobile app.

---

9. Select the printer from the list of available printers, and then select **Print**.
10. After the print job is complete, some mobile devices need to be reconnected to the local network.

The following devices and computer operating systems support **Wi-Fi Direct**:

- Android 4.0 and later tablets and phones with the HP Print Service or Mopria mobile printing plugin installed
- Most Windows 8.1 and Windows 10 computers, tablets, and laptops that have the HP print driver installed

The following devices and computer operating systems do not support **Wi-Fi Direct**, but can print to a printer that does:

- Apple iPhone and iPad
- Mac computers running OS X



For more information on Wi-Fi Direct printing, go to [www.hp.com/go/wirelessprinting](http://www.hp.com/go/wirelessprinting).

Wi-Fi Direct capabilities can be enabled or disabled from the HP Embedded Web Server (EWS).

## Enable or disable Wi-Fi Direct

Wi-Fi Direct capabilities must be enabled first from the printer EWS.

### Step one: Open the HP Embedded Web Server

1. Print a configuration page to determine the IP address or host name.
  - a. Press and hold the Resume  button until the Ready  light begins blinking.
  - b. Release the Resume  button.



2. Open a web browser, and in the address line, type the IP address or host name exactly as it displays on the printer configuration page. Press the **Enter** key on the computer keyboard. The EWS opens.

 <https://10.10.XX.XXX/>

 **NOTE:** If the web browser displays a message indicating that accessing the website might not be safe, select the option to continue to the website. Accessing this website will not harm the computer.

### Step two: Enable or disable Wi-Fi Direct



1. On the **Networking** tab, click the **Wi-Fi Direct Setup** link in the left navigation pane.
2. Select the **On** option, and then click **Apply**. Selecting the **Off** option disables Wi-Fi Direct printing.

 **NOTE:** In environments where more than one model of the same printer is installed, it might be helpful to provide each printer a unique Wi-Fi Direct name for easier printer identification for Wi-Fi Direct printing.

## Change the printer Wi-Fi Direct name

Follow this procedure to change the printer Wi-Fi Direct name using the HP Embedded Web Server (EWS):

### Step one: Open the HP Embedded Web Server

1. Print a configuration page to determine the IP address or host name.
  - a. Press and hold the Resume  button until the Ready  light begins blinking.
  - b. Release the Resume  button.
2. Open a web browser, and in the address line, type the IP address or host name exactly as it displays on the printer configuration page. Press the **Enter** key on the computer keyboard. The EWS opens.

 <https://10.10.XX.XXX/>

 **NOTE:** If the web browser displays a message indicating that accessing the website might not be safe, select the option to continue to the website. Accessing this website will not harm the computer.

### Step two: Change the Wi-Fi Direct name

1. On the **Networking** tab, click the **Wi-Fi Direct Setup** link in the left navigation pane.
2. In the **Wi-Fi Direct Name** field, enter the new name.
3. Click **Apply**.

## HP ePrint via email



Use HP ePrint to print documents by sending them as an email attachment to the printer's email address from any email enabled device.

To use HP ePrint, the printer must meet these requirements:

- The printer must be connected to a wired or wireless network and have Internet access.
- HP Web Services must be enabled on the printer, and the printer must be registered with HP Connected.

Follow this procedure to enable HP Web Services and register with HP Connected:

### Step one: Open the HP Embedded Web Server

1. Print a configuration page to determine the IP address or host name.
  - a. Press and hold the Resume  button until the Ready  light begins blinking.
  - b. Release the Resume  button.
2. Open a web browser, and in the address line, type the IP address or host name exactly as it displays on the configuration page. Press the **Enter** key on the computer keyboard. The EWS opens.

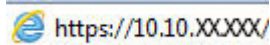
 <https://10.10.XX.XXX/>

 **NOTE:** If the web browser displays a message indicating that accessing the website might not be safe, select the option to continue to the website. Accessing this website will not harm the computer.

### Step two: Enable HP Web Services

1. Click the **HP Web Services** tab, and then click **Enable**. The printer enables Web Services, and then prints an information page.

The information page contains the printer code necessary to register the HP printer at HP Connected.

2. Go to [www.hpconnected.com](http://www.hpconnected.com) to create an HP ePrint account and complete the setup process.

## HP ePrint software

The HP ePrint software makes it easy to print from a Windows desktop or laptop computer to any HP ePrint-capable printer. This software makes it easy to find HP ePrint-enabled printers that are registered to your HP Connected account. The target HP printer can be located in the office or at locations across the globe.

HP ePrint software supports the following types of printing:

- TCP/IP printing to local network printers on the network (LAN or WAN) to products that support UPD PostScript®
- IPP printing to LAN or WAN network-connected products that support ePCL
- Printing PDF documents to public print locations and printing using HP ePrint via email through the cloud

 **NOTE:** HP ePrint Software does not support USB printing.

## How to get started

1. Go to [www.hp.com/go/eprintsoftware](http://www.hp.com/go/eprintsoftware) for drivers and information.



---

**NOTE:** For Windows, the name of the HP ePrint Software print driver is HP ePrint + JetAdvantage.

---

2. After installing the software, open the **Print** option from within your application, and then select **HP ePrint** from the installed printers list. Click the **Properties** button to configure print options.

## AirPrint

Direct printing using Apple's AirPrint is supported for iOS and from Mac computers running macOS 10.13 and newer. Use AirPrint to print directly to the printer from an iPad, iPhone (3GS or later), or iPod touch (third generation or later) in the following mobile applications:

- Mail
- Photos
- Safari
- iBooks
- Select third-party applications

To use AirPrint, the printer must be connected to the same network (sub-net) as the Apple device. For more information about using AirPrint and about which HP printers are compatible with AirPrint, go to [www.hp.com/go/LaserJetMobilePrinting](http://www.hp.com/go/LaserJetMobilePrinting).



---

**NOTE:** Before using AirPrint with a USB connection, verify the version number. AirPrint versions 1.3 and earlier do not support USB connections.

---

## Android embedded printing

HP's built-in print solution for Android and Kindle enables mobile devices to automatically find and print to HP printers that are either on a network or within wireless range for Wi-Fi Direct printing.

The printer must be connected to the same network (sub-net) as the Android device.

The print solution is built into the many versions of the operating system.



---

**NOTE:** If printing is not available on your device, go to the [Google Play > Android apps](#) and install the HP Print Service Plugin.

---

For more information on how to use Android embedded printing and which Android devices are supported, go to [www.hp.com/go/LaserJetMobilePrinting](http://www.hp.com/go/LaserJetMobilePrinting).



---

# 5 Manage the printer

- [Change the printer connection type \(Windows\)](#)
- [Advanced configuration with HP Embedded Web Server \(EWS\) and HP Device Toolbox \(Windows\)](#)
- [Advanced configuration with HP Utility for OS X](#)
- [Configure IP network settings](#)
- [Printer security features](#)
- [Configure the Quiet Print Mode settings](#)
- [Energy-conservation settings](#)
- [Update the firmware](#)

## For more information:

The following information is correct at the time of publication. For current information, see [www.hp.com/support/ljM118](http://www.hp.com/support/ljM118), [www.hp.com/support/ljM203](http://www.hp.com/support/ljM203).

HP's all-inclusive help for the printer includes the following information:

- Install and configure
- Learn and use
- Solve problems
- Download software and firmware updates
- Join support forums
- Find warranty and regulatory information

## Change the printer connection type (Windows)

If you are already using the printer and you wish to change the way it is connected, use **Device Setup & Software** to change the connection. For example, connect the new printer to the computer using a USB or network connection, or change the connection from a USB to a wireless connection.

To open **Device Setup & Software**, complete the following procedure:

1. Open the HP Printer Assistant.
  - **Windows 10:** From the **Start** menu, click **All Apps**, click **HP**, and then select the printer name.
  - **Windows 8.1:** Click the down arrow in lower left corner of the **Start** screen, and then select the printer name.
  - **Windows 8:** Right-click an empty area on the **Start** screen, click **All Apps** on the app bar, and then select the printer name.
  - **Windows 7, Windows Vista, and Windows XP:** From the computer desktop, click **Start**, select **All Programs**, click **HP**, click the folder for the printer, and then select the printer name.
2. In the HP Printer Assistant, select **Tools** from the navigation bar, and then select **Device Setup & Software**.

# Advanced configuration with HP Embedded Web Server (EWS) and HP Device Toolbox (Windows)

Use the HP Embedded Web Server to manage printing functions from a computer instead of the printer control panel.

- View printer status information
- Determine the remaining life for all supplies and order new ones
- View and change tray configurations
- View and change the printer control-panel menu configuration
- View and print internal pages
- Receive notification of printer and supplies events
- View and change network configuration

The HP Embedded Web Server works when the printer is connected to an IP-based network. The HP Embedded Web Server does not support IPX-based printer connections. Internet access is not needed to open and use the HP Embedded Web Server.

When the printer is connected to the network, the HP Embedded Web Server is automatically available.

---

 **NOTE:** HP Device Toolbox is software used to connect to the HP Embedded Web Server when the printer is connected to a computer via USB. It is available only if a full installation was performed when the printer was installed on a computer. Depending on how the printer is connected, some features might not be available.



 **NOTE:** The HP Embedded Web Server is not accessible beyond the network firewall.

---

## Method one: Open the HP Embedded Web Server (EWS) from the software

1. Open the HP Printer Assistant.
  - **Windows 10:** From the **Start** menu, click **All Apps**, click **HP**, and then select the printer name.
  - **Windows 8.1:** Click the down arrow in lower left corner of the **Start** screen, and then select the printer name.
  - **Windows 8:** Right-click an empty area on the **Start** screen, click **All Apps** on the app bar, and then select the printer name.
  - **Windows 7, Windows Vista, and Windows XP:** From the computer desktop, click **Start**, select **All Programs**, click **HP**, click the folder for the printer, and then select the printer name.
2. In the HP Printer Assistant, select **Print**, and then select **HP Device Toolbox**.

## Method two: Open the HP Embedded Web Server (EWS) from a web browser

1. Print a configuration page to determine the IP address or host name.
  - a. Press and hold the Resume  button until the Ready  light begins blinking.
  - b. Release the Resume  button.

- Open a web browser, and in the address line, type the IP address or host name exactly as it displays on the printer configuration page. Press the **Enter** key on the computer keyboard. The EWS opens.

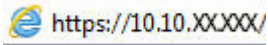

 **NOTE:** If the web browser displays a message indicating that accessing the website might not be safe, select the option to continue to the website. Accessing this website will not harm the computer.

Tab or section	Description
<p><b>Home tab</b></p> <p>Provides printer, status, and configuration information.</p>	<ul style="list-style-type: none"> <li>• <b>Device Status:</b> Shows the printer status and shows the approximate percent life remaining of HP supplies.</li> <li>• <b>Supplies Status:</b> Shows the approximate percent life remaining of HP supplies. Actual supply life remaining can vary. Consider having a replacement supply available to install when print quality is no longer acceptable. The supply does not need to be replaced unless the print quality is no longer acceptable.</li> <li>• <b>Device Configuration:</b> Shows the information found on the printer configuration page.</li> <li>• <b>Network Summary:</b> Shows the information found on the printer network configuration page.</li> <li>• <b>Reports:</b> Print the configuration and supplies status pages that the printer generates.</li> <li>• <b>Job Storage Log:</b> Shows a summary of all jobs stored in the printer memory. (Job storage printers only)</li> <li>• <b>Color Usage Log:</b> Shows a summary of color jobs that the printer has produced. (Color printers only)</li> <li>• <b>Event Log:</b> Shows a list of all printer events and errors.</li> <li>• <b>Open Source Licenses:</b> Shows a summary of the licenses for open source software programs that can be used with the printer.</li> </ul>



Tab or section	Description
<p><b>System tab</b></p> <p>Provides the ability to configure the printer from your computer.</p>	<ul style="list-style-type: none"> <li>• <b>Device Information:</b> Provides basic printer and company information.</li> <li>• <b>Paper Setup:</b> Change the default paper-handling settings for the printer.</li> <li>• <b>Print Quality:</b> Change the default print-quality settings for the printer.</li> <li>• <b>Energy Settings:</b> Change the default times for entering Sleep/Auto Off mode or automatic shut down.</li> <li>• <b>Job Storage Setup:</b> Configure the job storage settings for the printer. (Job storage printers only)</li> <li>• <b>Paper Types:</b> Configure print modes that correspond to the paper types that the printer accepts.</li> <li>• <b>System Setup:</b> Change the system defaults for the printer.</li> <li>• <b>Supply Settings:</b> Change the settings for <b>Cartridge is low</b> alerts and other supplies information.</li> <li>• <b>Service:</b> Perform the cleaning procedure on the printer.</li> <li>• <b>Save and Restore:</b> Save the current settings for the printer to a file on the computer. Use this file to load the same settings onto another printer or to restore these settings to this printer at a later time.</li> <li>• <b>Administration:</b> Set or change the printer password. Enable or disable printer features.</li> </ul> <p><b>NOTE:</b> The <b>System</b> tab can be password-protected. If this printer is on a network, always consult with the administrator before changing settings on this tab.</p>
<p><b>Print tab</b></p> <p>Provides the ability to change default print settings from your computer.</p>	<ul style="list-style-type: none"> <li>• <b>Printing:</b> Change the default printer print settings, such as number of copies and paper orientation. These are the same options that are available on the control panel.</li> <li>• <b>PostScript:</b> Turn off or on the <b>Print PS Errors</b> feature.</li> </ul>
<p><b>Networking tab</b></p> <p>(Network-connected printers only)</p> <p>Provides the ability to change network settings from your computer.</p>	<p>Network administrators can use this tab to control network-related settings for the printer when it is connected to an IP-based network. It also allows the network administrator to set up Wi-Fi Direct functionality. This tab does not appear if the printer is directly connected to a computer.</p>
<p><b>HP Web Services tab</b></p>	<p>Use this tab to set up and use various Web tools with the printer.</p>

# Advanced configuration with HP Utility for OS X

Use the HP Utility to check printer status or to view or change printer settings from a computer.

You can use the HP Utility when the printer is connected with a USB cable or is connected to a TCP/IP-based network.

## Open HP Utility

1. At the computer, open the **Applications** folder.
2. Select **HP**, and then select **HP Utility**.

## HP Utility features

The HP Utility toolbar includes these items:

- **Devices:** Click this button to show or hide Mac products found by the HP Utility.
- **All Settings:** Click this button to return to the HP Utility main view.
- **HP Support:** Click this button to open a browser and go to the HP support website.
- **Supplies:** Click this button to open the HP SureSupply website.
- **Registration:** Click this button to open the HP registration website.
- **Recycling:** Click this button to open the HP Planet Partners Recycling Program website.

HP Utility consists of pages that you open by clicking in the **All Settings** list. The following table describes the tasks that you can perform with HP Utility.

Item	Description
<b>Supplies Status</b>	Show the printer supplies status and provides links for ordering supplies online.
<b>Device Information</b>	Show information about the currently selected printer, including the printer Service ID (if assigned), the firmware version (FW Version), the Serial Number, and the IP address.
<b>Commands</b>	Send special characters or print commands to the printer after the print job.  <b>NOTE:</b> This option is available only after you open the <b>View</b> menu and select the <b>Show Advanced Options</b> item.
<b>Color Usage</b>  (Color printers only)	Show information about color jobs that the printer has produced.
<b>File Upload</b>	Transfer files from the computer to the printer. You can upload the following types of files: <ul style="list-style-type: none"><li>○ HP LaserJet printer command language (.PRN)</li><li>○ Portable document format (.PDF)</li><li>○ Postscript (.PS)</li><li>○ Text (.TXT)</li></ul>
<b>Power Management</b>	Configure the printer economy settings.

Item	Description
Update Firmware	Transfer a firmware update file to the printer.  <b>NOTE:</b> This option is available only after you open the <b>View</b> menu and select the <b>Show Advanced Options</b> item.
HP Connected	Access the HP Connected website.
Message Center	Display error events that have occurred with the printer.
Network Settings (Network-connected printers only)	Configure the network settings, such as the IPv4 settings, IPv6 settings, Bonjour settings, and other settings.
Supplies Management	Configure how the printer should behave when supplies are nearing the end of their estimated life.
Trays Configuration	Change paper size and type for each of the trays.
Additional Settings	Open the HP Embedded Web Server (EWS) for the printer.  <b>NOTE:</b> USB connections are not supported.
Proxy Server Settings	Configure a proxy server for the printer.

# Configure IP network settings

- [Introduction](#)
- [Printer sharing disclaimer](#)
- [View or change network settings](#)
- [Rename the printer on a network](#)
- [Manually configure IPv4 TCP/IP parameters](#)
- [Link speed and duplex settings](#)

## Introduction



Use the following sections to configure the printer network settings.

## Printer sharing disclaimer

HP does not support peer-to-peer networking, as the feature is a function of Microsoft operating systems and not of the HP printer drivers. Go to Microsoft at [www.microsoft.com](http://www.microsoft.com).

## View or change network settings

Use the HP Embedded Web Server to view or change IP configuration settings.

1. Open the HP Embedded Web Server (EWS):
  - a. Print a configuration page to determine the IP address or host name.
    - i. Press and hold the Resume  button until the Ready  light begins blinking.
    - ii. Release the Resume  button.
  - b. Open a web browser, and in the address line, type the IP address or host name exactly as it displays on the printer configuration page. Press the **Enter** key on the computer keyboard. The EWS opens.

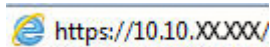



**NOTE:** If the web browser displays a message indicating that accessing the website might not be safe, select the option to continue to the website. Accessing this website will not harm the computer.

2. Click the **Networking** tab to obtain network information. Change settings as needed.

## Rename the printer on a network

To rename the printer on a network so that it can be uniquely identified, use the HP Embedded Web Server.

1. Open the HP Embedded Web Server (EWS):
  - a. Print a configuration page to determine the IP address or host name.

- i. Press and hold the Resume  button until the Ready  light begins blinking.
  - ii. Release the Resume  button.
- b. Open a web browser, and in the address line, type the IP address or host name exactly as it displays on the printer configuration page. Press the **Enter** key on the computer keyboard. The EWS opens.

 <https://10.10.XXXXX/>

 **NOTE:** If the web browser displays a message indicating that accessing the website might not be safe, select the option to continue to the website. Accessing this website will not harm the computer.



2. Open the **System** tab.
3. On the **Device Information** page, the default printer name is in the **Device Description** field. You can change this name to uniquely identify this printer.

 **NOTE:** Completing the other fields on this page is optional.

4. Click the **Apply** button to save the changes.

## Manually configure IPv4 TCP/IP parameters

Use the EWS to manually set an IPv4 address, subnet mask, and default gateway.

1. Open the HP Embedded Web Server (EWS):
  - a. Print a configuration page to determine the IP address or host name.
    - i. Press and hold the Resume  button until the Ready  light begins blinking.
    - ii. Release the Resume  button.
  - b. Open a web browser, and in the address line, type the IP address or host name exactly as it displays on the printer configuration page. Press the **Enter** key on the computer keyboard. The EWS opens.

 <https://10.10.XXXXX/>

 **NOTE:** If the web browser displays a message indicating that accessing the website might not be safe, select the option to continue to the website. Accessing this website will not harm the computer.

2. On the **Networking** tab, click the **IPv4 Config Method** in the left navigation pane.
3. From the **IP Preferred Address Method** drop-down, select **Manual**, and then edit the IPv4 configuration settings.
4. Click the **Apply** button.



## Link speed and duplex settings

 **NOTE:** This information applies only to Ethernet networks. It does not apply to wireless networks.

The link speed and communication mode of the print server must match the network hub. For most situations, leave the printer in automatic mode. Incorrect changes to the link speed and duplex settings might prevent the printer from communicating with other network devices. To make changes, use the printer control panel.

 **NOTE:** The printer setting must match the setting for the network device (a network hub, switch, gateway, router, or computer).

 **NOTE:** Making changes to these settings causes the printer to turn off and then on. Make changes only when the printer is idle.

1. Open the HP Embedded Web Server (EWS):
  - a. Print a configuration page to determine the IP address or host name.
    - i. Press and hold the Resume  button until the Ready  light begins blinking.
    - ii. Release the Resume  button.
  - b. Open a web browser, and in the address line, type the IP address or host name exactly as it displays on the printer configuration page. Press the **Enter** key on the computer keyboard. The EWS opens.

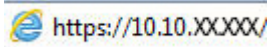
 <https://10.10.XX.XXX/>

 **NOTE:** If the web browser displays a message indicating that accessing the website might not be safe, select the option to continue to the website. Accessing this website will not harm the computer.

2. On the **Networking** tab, click the **Advanced** link in the left navigation pane.
3. In the **Other Settings** area, select one of the following options:
  - **Automatic:** The print server automatically configures itself for the highest link speed and communication mode allowed on the network.
  - **10T Full:** 10 megabytes per second (Mbps), full-duplex operation
  - **10T Half:** 10 Mbps, half-duplex operation
  - **100TX Full:** 100 Mbps, full-duplex operation
  - **100TX Half:** 100 Mbps, half-duplex operation
4. Click the **Apply** button. The printer turns off and then on.

# Printer security features

## Introduction

The printer includes several security features to restrict who has access to configuration settings, to secure data, and to prevent access to valuable hardware components.

- [Assign or change the system password using the HP Embedded Web Server](#)
- [Lock the formatter](#)

## Assign or change the system password using the HP Embedded Web Server



Assign an administrator password for access to the printer and the HP Embedded Web Server so that unauthorized users cannot change the printer settings.

1. Open the HP Embedded Web Server (EWS):

### Direct-connected printers

- a. Open the HP Printer Assistant.
  - **Windows 10:** From the **Start** menu, click **All Apps**, click **HP**, and then select the printer name.
  - **Windows 8.1:** Click the down arrow in lower left corner of the **Start** screen, and then select the printer name.
  - **Windows 8:** Right-click an empty area on the **Start** screen, click **All Apps** on the app bar, and then select the printer name.
  - **Windows 7, Windows Vista, and Windows XP:** From the computer desktop, click **Start**, select **All Programs**, click **HP**, click the folder for the printer, and then select the printer name.
- b. In the HP Printer Assistant, select **Print**, and then select **HP Device Toolbox**.

### Network-connected printers

- a. Print a configuration page to determine the IP address or host name.
  - i. Press and hold the Resume  button until the Ready  light begins blinking.
  - ii. Release the Resume  button.
- b. Open a web browser, and in the address line, type the IP address or host name exactly as it displays on the printer configuration page. Press the **Enter** key on the computer keyboard. The EWS opens.

 <https://10.10.XXXXX/>

 **NOTE:** If the web browser displays a message indicating that accessing the website might not be safe, select the option to continue to the website. Accessing this website will not harm the computer.

2. On the **System** tab, click the **Administration** link in the left navigation pane.
3. In the area labeled **Product Security**, enter the password in the **Password** field.

4. Re-enter the password in the **Confirm Password** field.
5. Click the **Apply** button.



**NOTE:** Make note of the password and store it in a safe place.

---

## Lock the formatter

The formatter has a slot that you can use to attach a security cable. Locking the formatter prevents someone from removing valuable components from it.



# Configure the Quiet Print Mode settings

## Introduction



This printer has a quiet mode that reduces noise during printing. When quiet mode is turned on, the printer prints at a slower speed.

---

 **NOTE:** Quiet Print Mode reduces the printer print speed, which might improve print quality.

---

## Configure the Quiet Print Mode settings from HP Embedded Web Server (EWS)

1. Print a configuration page to determine the IP address or host name.
  - a. Press and hold the Resume  button until the Ready  light begins blinking.
  - b. Release the Resume  button.
2. Open a Web browser, and in the address line, type the IP address or host name exactly as it displays on the printer configuration page. Press the **Enter** key on the computer keyboard. The EWS opens.

 <https://10.10.XX.XX/>

---

 **NOTE:** If the Web browser displays a message indicating that accessing the website might not be safe, select the option to continue to the website. Accessing this website will not harm the computer.

---

3. Click the **System** tab.
4. On the left navigation pane, click the **Paper Types** link.
5. From the **Quiet Print Mode** drop-down, select **On**. Click **Apply**.

# Energy-conservation settings

- [Introduction](#)
- [Print with EconoMode](#)
- [Set the Sleep/Auto Off After Inactivity setting](#)
- [Set the Shut Down After Inactivity delay and configure the printer to use 1 watt or less of power](#)
- [Set the Delay Shut Down setting](#)

## Introduction

The printer includes several economy features to conserve energy and supplies.

## Print with EconoMode

This printer has an EconoMode option for printing drafts of documents. Using EconoMode can use less toner. However, using EconoMode can also reduce print quality.

HP does not recommend the full-time use of EconoMode. If EconoMode is used full-time, the toner supply might outlast the mechanical parts in the toner cartridge. If print quality begins to degrade and is no longer acceptable, consider replacing the toner cartridge.



**NOTE:** If this option is not available in your print driver, you can set it using the HP Embedded Web Server.

1. From the software program, select the **Print** option.
2. Select the printer, and then click the **Properties** or **Preferences** button.
3. Click the **Paper/Quality** tab.
4. Click the **EconoMode** check box.

## Set the Sleep/Auto Off After Inactivity setting

Use the EWS to set the amount of idle time before the printer enters sleep mode.

Complete the following procedure to change the Sleep/Auto Off After setting:

1. Open the HP Embedded Web Server (EWS):



### Direct-connected printers

- a. Open the HP Printer Assistant.
  - **Windows 10:** From the **Start** menu, click **All Apps**, click **HP**, and then select the printer name.
  - **Windows 8.1:** Click the down arrow in lower left corner of the **Start** screen, and then select the printer name.

- **Windows 8:** Right-click an empty area on the **Start** screen, click **All Apps** on the app bar, and then select the printer name.
- **Windows 7, Windows Vista, and Windows XP:** From the computer desktop, click **Start**, select **All Programs**, click **HP**, click the folder for the printer, and then select the printer name.

b. In the HP Printer Assistant, select **Print**, and then select **HP Device Toolbox**.

### Network-connected printers

- Print a configuration page to determine the IP address or host name.
  - Press and hold the Resume  button until the Ready  light begins blinking.
  - Release the Resume  button.
- Open a web browser, and in the address line, type the IP address or host name exactly as it displays on the printer configuration page. Press the **Enter** key on the computer keyboard. The EWS opens.

 <https://10.10.XXXXX/>

 **NOTE:** If the web browser displays a message indicating that accessing the website might not be safe, select the option to continue to the website. Accessing this website will not harm the computer.

- Click the **System** tab, and then select the **Energy Settings** page.
- From the **Sleep/Auto Off After Inactivity** drop-down, select the time for the delay.
- Click the **Apply** button.

## Set the Shut Down After Inactivity delay and configure the printer to use 1 watt or less of power

Use the EWS to set the amount of time before the printer shuts down.

 **NOTE:** After the printer shuts down, the power consumption is 1 watt or less.



Complete the following procedure to change the Shut Down After Delay setting:

- Open the HP Embedded Web Server (EWS):

### Direct-connected printers

- Open the HP Printer Assistant.
  - **Windows 10:** From the **Start** menu, click **All Apps**, click **HP**, and then select the printer name.
  - **Windows 8.1:** Click the down arrow in lower left corner of the **Start** screen, and then select the printer name.
  - **Windows 8:** Right-click an empty area on the **Start** screen, click **All Apps** on the app bar, and then select the printer name.
  - **Windows 7, Windows Vista, and Windows XP:** From the computer desktop, click **Start**, select **All Programs**, click **HP**, click the folder for the printer, and then select the printer name.
- In the HP Printer Assistant, select **Print**, and then select **HP Device Toolbox**.

### Network-connected printers

- a. Print a configuration page to determine the IP address or host name.
  - i. Press and hold the Resume  button until the Ready  light begins blinking.
  - ii. Release the Resume  button.
- b. Open a web browser, and in the address line, type the IP address or host name exactly as it displays on the printer configuration page. Press the **Enter** key on the computer keyboard. The EWS opens.

 <https://10.10.XXXXX/>

 **NOTE:** If the displays a message indicating that accessing the website might not be safe, select the option to continue to the website. Accessing this website will not harm the computer.

2. Click the **System** tab, and then select the **Energy Settings** page.
3. From the **Shut Down After Inactivity** drop-down, select the time for the delay.

 **NOTE:** The default value is **4 hours**.

4. Click the **Apply** button.

## Set the Delay Shut Down setting

Use the EWS to select whether or not the printer delays shutting down after the power button is pressed.



Complete the following procedure to change the Delay Shut Down setting:

1. Open the HP Embedded Web Server (EWS):

### Direct-connected printers

- a. Open the HP Printer Assistant.
  - **Windows 10:** From the **Start** menu, click **All Apps**, click **HP**, and then select the printer name.
  - **Windows 8.1:** Click the down arrow in lower left corner of the **Start** screen, and then select the printer name.
  - **Windows 8:** Right-click an empty area on the **Start** screen, click **All Apps** on the app bar, and then select the printer name.
  - **Windows 7, Windows Vista, and Windows XP:** From the computer desktop, click **Start**, select **All Programs**, click **HP**, click the folder for the printer, and then select the printer name.
- b. In the HP Printer Assistant, select **Print**, and then select **HP Device Toolbox**.

### Network-connected printers

- a. Print a configuration page to determine the IP address or host name.
  - i. Press and hold the Resume  button until the Ready  light begins blinking.
  - ii. Release the Resume  button.

- b. Open a web browser, and in the address line, type the IP address or host name exactly as it displays on the printer configuration page. Press the **Enter** key on the computer keyboard. The EWS opens.

 <https://10.10.XXXXX/>

---

 **NOTE:** If the displays a message indicating that accessing the website might not be safe, select the option to continue to the website. Accessing this website will not harm the computer.

---

2. Click the **System** tab, and then select the **Energy Settings** page.
3. In the **Delay Shut Down** area, select or clear the **Delay when ports are active** option.

---

 **NOTE:** When this option is selected the printer will not shut down unless all ports are inactive. An active network link or fax connection will prevent the printer from shutting down.

---

## Update the firmware

HP offers periodic printer updates, new Web Services apps, and new features to existing Web Services apps. Follow these steps to update the printer firmware for a single printer. When you update the firmware, Web Service apps will update automatically.

### Update the firmware using the Firmware Update Utility

Use these steps to manually download and install the Firmware Update Utility from HP.com.

---

 **NOTE:** This method is the only firmware update option available for printers connected to the computer via a USB cable. It also works for printers connected to a network.

 **NOTE:** You must have a print driver installed in order to use this method.

---

1. Go to [www.hp.com/go/support](http://www.hp.com/go/support), select your country/region or language, and then click the **Get software and drivers** link.
2. Type the printer name in the search field, press the **ENTER** button, and then select the printer from the list of search results.
3. Select the operating system.
4. Under the **Firmware** section, locate the **Firmware Update Utility**.
5. Click **Download**, click **Run**, and then click **Run** again.
6. When the utility launches, select the printer from the drop-down list, and then click **Send Firmware**.

---

 **NOTE:** To print a configuration page to verify the installed firmware version before or after the update process, click **Print Config**.

---

7. Follow the on-screen instructions to complete the installation, and then click the **Exit** button to close the utility.

---

# 6 Solve problems

- [Customer support](#)
- [Interpret control-panel light patterns](#)
- [Restore the factory-set defaults](#)
- [A “Cartridge is low” or “Cartridge is very low” message displays on the printer control panel](#)
- [Printer does not pick up paper or misfeeds](#)
- [Clear paper jams](#)
- [Improve print quality](#)
- [Solve wired network problems](#)
- [Solve wireless network problems](#)

## For more information:

The following information is correct at the time of publication. For current information, see [www.hp.com/support/ljM118](http://www.hp.com/support/ljM118), [www.hp.com/support/ljM203](http://www.hp.com/support/ljM203).

HP's all-inclusive help for the printer includes the following information:

- Install and configure
- Learn and use
- Solve problems
- Download software and firmware updates
- Join support forums
- Find warranty and regulatory information

# Customer support

---

Get telephone support for your country/region	Country/region phone numbers are on the flyer that was in the box with the printer or at <a href="http://support.hp.com">support.hp.com</a> .
Have the printer name, serial number, date of purchase, and problem description ready	
Get 24-hour Internet support, and download software utilities and drivers	<a href="http://www.hp.com/support/ljM118">www.hp.com/support/ljM118</a> , <a href="http://www.hp.com/support/ljM203">www.hp.com/support/ljM203</a>
Order additional HP service or maintenance agreements	<a href="http://www.hp.com/go/carepack">www.hp.com/go/carepack</a>
Register the printer	<a href="http://www.register.hp.com">www.register.hp.com</a>



---









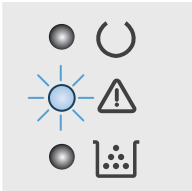

# Interpret control-panel light patterns

If the printer requires attention, an error code appears on the control-panel display.







**Table 6-1 Status-light legend**

	Symbol for "light off"
	Symbol for "light on"
	Symbol for "light blinking"

**Table 6-2 Control-panel light patterns**

Light status	State of the printer	Action
<p>The Attention light is blinking.</p> 	The printer is in manual-feed mode.	Load the correct paper type and size into the input tray. Press the Resume  button to continue.
	The printer is processing a manual duplex job.	Load the pages into the input tray to print the second sides. Press the Resume  button to continue.
	Input tray is empty or loaded with an unexpected paper size.	Load plain paper or press the Resume  button to continue with the paper currently loaded.
	The input tray is empty.	Load the tray.
	A door is open.	Verify that the top cover is fully closed.
	The printer failed to pick a sheet of paper to print.	Press Resume  to continue.
	Paper is jammed in the input tray.	Clear the jam.
	Paper is jammed in the toner cartridge area.	Clear the jam.
	Paper is jammed in the output bin area.	Clear the jam.
	The loaded paper is not the size needed for the print job.	Replace the paper, or press Resume  to continue with the size currently loaded.
	The printer has experienced a general engine error.	Press Resume  to continue.  If the error repeats, turn off the printer. Wait 30 seconds, and then turn on the printer.
	Incorrect firmware has been loaded.	Press Resume  to continue. Load the correct firmware.

**Table 6-2 Control-panel light patterns (continued)**

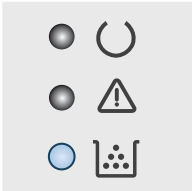
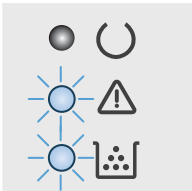
Light status	State of the printer	Action
	The printer has experienced a bad code signature.	Press Resume  to accept the signature, or press Cancel  to stop the upgrade.
	The printer has canceled a bad code signature upgrade.	Press Resume  to continue.
	The printer has experienced an engine cable error.	Press Resume  to continue.  If the error persists, contact HP customer support.
	The printer has experienced a control-panel cable error.	Press Resume  to continue.  If the error persists, contact HP customer support.
The Attention light is blinking and the Toner light is on.  	The toner cartridge is very low.	Consider having a replacement available to install when print quality is no longer acceptable.
	The imaging drum is very low.	Consider having a replacement available to install when print quality is no longer acceptable.
	Multiple supplies are low.	Consider having replacements available to install when print quality is no longer acceptable.
The Toner light is on.  	The toner cartridge has reached its estimated end of life. Once a toner cartridge has reached its estimated end of life, the HP Premium Protection Warranty on that toner cartridge has ended.	Consider having a replacement available to install when print quality is no longer acceptable. The toner cartridge does not need to be replaced now unless the print quality is no longer acceptable.
	The imaging drum has reached its estimated end of life. Once an imaging drum has reached its estimated end of life, the HP Premium Protection Warranty on that imaging drum has ended.	Consider having a replacement available to install when print quality is no longer acceptable. The imaging drum does not need to be replaced now unless the print quality is no longer acceptable.
	Multiple supplies have reached their estimated end of life. Once a supply has reached its estimated end of life, the HP Premium Protection Warranty on that supply has ended.	Consider having replacement supplies available to install when print quality is no longer acceptable. The supplies do not need to be replaced now unless the print quality is no longer acceptable.
The Attention and Toner lights are blinking.  	The toner cartridge or imaging drum is missing or incorrectly installed.	Install or reinstall the toner cartridge and imaging drum.

**Table 6-2 Control-panel light patterns (continued)**

Light status	State of the printer	Action
	The toner cartridge is incompatible with the printer, possibly due to a missing or damaged memory chip.	Replace the toner cartridge.
	The imaging drum is incompatible with the printer, possibly due to a missing or damaged memory chip.	Replace the imaging drum.
	Multiple supplies are incompatible with the printer, possibly due to a missing or damaged memory chip.	Replace the supplies.
	The toner cartridge has been protected on another printer.	Replace the toner cartridge.
	The imaging drum has been protected on another printer.	Replace the imaging drum.
	Multiple supplies have been protected on another printer.	Replace the supplies.
	An unauthorized toner cartridge is installed.	Replace the toner cartridge.
	An unauthorized imaging drum is installed.	Replace the imaging drum.
	Unauthorized supplies are installed.	Replace the supplies.
	The cartridge sensor has experienced an error.	Replace the toner cartridge.
	An MICR toner cartridge must be installed.	Install an MICR toner cartridge.
The Attention and Ready lights are on.	The printer has experienced a fatal error from which it cannot recover.	<ol style="list-style-type: none"> <li>1. Turn off the printer or disconnect the power cord from the printer.</li> <li>2. Wait 30 seconds, and then turn on the printer or reconnect the power cord to the printer.</li> <li>3. Wait for the printer to initialize.</li> </ol> <p>If the error persists, contact HP customer support.</p>

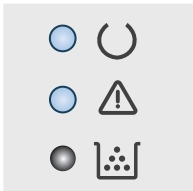

## Restore the factory-set defaults

Restoring the factory-set defaults returns all of the printer and network settings to the factory defaults. It will not reset the page count, tray size, or language. To restore the printer to the factory-default settings, follow these steps.

---

**CAUTION:** Restoring the factory-set defaults returns all of the settings to the factory defaults, and it also deletes any pages that are stored in the memory.



---

### 1.

#### Direct-connected printers

- a. Open the HP Printer Assistant.
  - **Windows 10:** From the **Start** menu, click **All Apps**, click **HP**, and then select the printer name.
  - **Windows 8.1:** Click the down arrow in lower left corner of the **Start** screen, and then select the printer name.
  - **Windows 8:** Right-click an empty area on the **Start** screen, click **All Apps** on the app bar, and then select the printer name.
  - **Windows 7, Windows Vista, and Windows XP:** From the computer desktop, click **Start**, select **All Programs**, click **HP**, click the folder for the printer, and then select the printer name.
- b. In the HP Printer Assistant, select **Print**, and then select **HP Device Toolbox**.

#### Network-connected printers

- a. Print a configuration page to determine the IP address or host name.
  - i. Press and hold the Resume  button until the Ready  light begins blinking.
  - ii. Release the Resume  button.
- b. Open a web browser, and in the address line, type the IP address or host name exactly as it displays on the printer configuration page. Press the **Enter** key on the computer keyboard. The EWS opens.

 <https://10.10.XX.XXX/>

---

 **NOTE:** If the displays a message indicating that accessing the website might not be safe, select the option to continue to the website. Accessing this website will not harm the computer.

---

2. On the **System** tab, click **Save and Restore** in the left navigation pane.
3. In the **Restore Defaults** area, click the **Restore defaults** button.

The printer automatically restarts.

## A “Cartridge is low” or “Cartridge is very low” message displays on the printer control panel

**Cartridge is low:** The printer indicates when a cartridge level is low. Actual cartridge life remaining may vary. Consider having a replacement available to install when print quality is no longer acceptable. The cartridge does not need to be replaced now.

**Cartridge is very low:** The printer indicates when the cartridge level is very low. Actual cartridge life remaining may vary. Consider having a replacement available to install when print quality is no longer acceptable. The cartridge does not need to be replaced now unless the print quality is no longer acceptable.

Once an HP cartridge has reached **Very Low**, HP’s Premium Protection Warranty on that toner cartridge has ended.

### Change the “Very Low” settings



You can change the way the printer reacts when supplies reach the Very Low state. You do not have to re-establish these settings when you install a new cartridge.

1. Open the HP Embedded Web Server (EWS):

#### Direct-connected printers

- a. Open the HP Printer Assistant.
  - **Windows 10:** From the **Start** menu, click **All Apps**, click **HP**, and then select the printer name.
  - **Windows 8.1:** Click the down arrow in lower left corner of the **Start** screen, and then select the printer name.
  - **Windows 8:** Right-click an empty area on the **Start** screen, click **All Apps** on the app bar, and then select the printer name.
  - **Windows 7, Windows Vista, and Windows XP:** From the computer desktop, click **Start**, select **All Programs**, click **HP**, click the folder for the printer, and then select the printer name.
- b. In the HP Printer Assistant, select **Print**, and then select **HP Device Toolbox**.

#### Network-connected printers

- a. Print a configuration page to determine the IP address or host name.
  - i. Press and hold the Resume  button until the Ready  light begins blinking.
  - ii. Release the Resume  button.

- b. Open a web browser, and in the address line, type the IP address or host name exactly as it displays on the printer configuration page. Press the **Enter** key on the computer keyboard. The EWS opens.

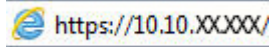

 **NOTE:** If the displays a message indicating that accessing the website might not be safe, select the option to continue to the website. Accessing this website will not harm the computer.

2. Select the **System** tab, and then select **Supply Settings**.
3. Select one of the following options from the **Very Low Setting (Black Cartridge):** or **Very Low Setting (Imaging Drum):** drop-down:
  - Select the **Continue** option to set the printer to alert you that the toner cartridge is very low, but to continue printing.
  - Select the **Stop** option to set the printer to stop printing until you replace the toner cartridge.
  - Select the **Prompt** option to set the printer to stop printing and prompt you to replace the toner cartridge. You can acknowledge the prompt and continue printing.

## Order supplies

Order supplies and paper	<a href="http://www.hp.com/go/suresupply">www.hp.com/go/suresupply</a>
Order through service or support providers	Contact an HP-authorized service or support provider.
Order using the HP Embedded Web Server (EWS)	To access, in a supported on your computer, enter the printer IP address or host name in the address/URL field. The EWS contains a link to the HP SureSupply website, which provides options for purchasing Original HP supplies.

# Printer does not pick up paper or misfeeds

## Introduction

The following solutions can help solve problems if the printer is not picking up paper from the tray or is picking up multiple sheets of paper at one time. Either of these situations can result in paper jams.

- [The printer does not pick up paper](#)
- [The printer picks up multiple sheets of paper](#)

## The printer does not pick up paper

If the printer does not pick up paper from the tray, try these solutions.

1. Open the printer and remove any jammed sheets of paper. Verify that no torn remnants of paper remain inside the printer.
2. Load the tray with the correct size of paper for the job.
3. Make sure the paper size and type are set correctly.
4. Make sure the paper guides in the tray are adjusted correctly for the size of paper. Adjust the guides to the appropriate indentation in the tray. The arrow on the tray guide should line up exactly with the marking on the tray.

---

 **NOTE:** Do not adjust the paper guides tightly against the paper stack. Adjust them to the indentations or markings in the tray.

---

5. Verify that the humidity in the room is within specifications for this printer and that paper is being stored in unopened packages. Most reams of paper are sold in moisture-proof wrapping to keep paper dry.

In high-humidity environments, paper at the top of the stack in the tray can absorb moisture, and it might have a wavy or uneven appearance. If this happens, remove the top 5 to 10 sheets of paper from the stack.

In low-humidity environments, excess static electricity can cause sheets of paper to stick together. If this happens, remove the paper from the tray, and flex the stack by holding it at each end and bringing the ends up to form a U shape. Then, rotate the ends down to reverse the U shape. Next, hold each side of the stack of paper, and repeat this process. This process releases individual sheets without introducing static electricity. Straighten the paper stack against a table before returning it to the tray.

**Figure 6-1** Technique for flexing the paper stack

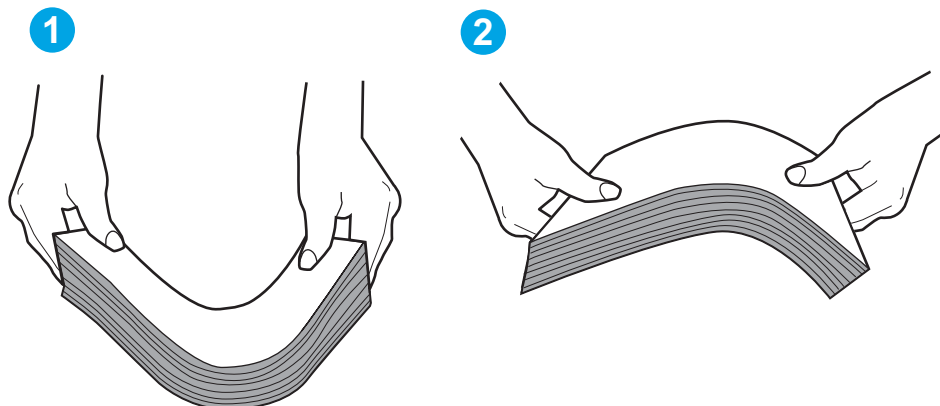

6. Check the printer control panel to see if it is displaying a prompt to feed the paper manually. Load paper, and continue.
7. The rollers above the tray might be contaminated. Clean the rollers with a lint-free cloth dampened with warm water. Use distilled water, if it is available.

**CAUTION:** Do not spray water directly on to the printer. Instead, spray water on the cloth or dab the cloth in water and wring it out before cleaning the rollers.

## The printer picks up multiple sheets of paper

If the printer picks up multiple sheets of paper from the tray, try these solutions.

1. Remove the stack of paper from the tray and flex it, rotate it 180 degrees, and flip it over. *Do not fan the paper.* Return the stack of paper to the tray.

**NOTE:** Fanning the paper introduces static electricity. Instead of fanning the paper, flex the stack by holding it at each end and bringing the ends up to form a U shape. Then, rotate the ends down to reverse the U shape. Next, hold each side of the stack of paper, and repeat this process. This process releases individual sheets without introducing static electricity. Straighten the paper stack against a table before returning it to the tray.

Figure 6-2 Technique for flexing the paper stack

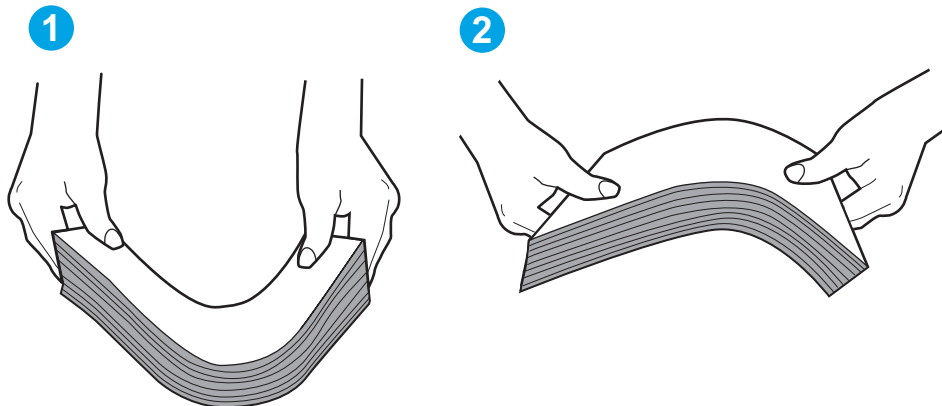

2. Use only paper that meets HP specifications for this printer.
3. Verify that the humidity in the room is within specifications for this printer, and that paper is being stored in unopened packages. Most reams of paper are sold in moisture-proof wrapping to keep paper dry.

In high-humidity environments, paper at the top of the stack in the tray can absorb moisture, and it might have a wavy or uneven appearance. If this happens, remove the top 5 to 10 sheets of paper from the stack.

In low-humidity environments, excess static electricity can cause sheets of paper to stick together. If this happens, remove the paper from the tray, and flex the stack as described above.

4. Use paper that is not wrinkled, folded, or damaged. If necessary, use paper from a different package.
5. Make sure the tray is not overfilled by checking the stack-height markings inside the tray. If it is overfilled, remove the entire stack of paper from the tray, straighten the stack, and then return some of the paper to the tray.

The following images show examples of the stack-height markings in the trays for various printers. Most HP printers have markings similar to these. Also make sure that all sheets of paper are below the tabs near the stack-height marks. These tabs help hold the paper in the correct position as it enters the printer.



6. Make sure the paper guides in the tray are adjusted correctly for the size of paper. Adjust the guides to the appropriate indentation in the tray. The arrow on the tray guide should line up exactly with the marking on the tray.



---

**NOTE:** Do not adjust the paper guides tightly against the paper stack. Adjust them to the indentations or markings in the tray.

---

7. Make sure the printing environment is within recommended specifications.

# Clear paper jams

## Introduction

The following information includes instructions for clearing paper jams from the printer.

- [Jam locations](#)
- [Experiencing frequent or recurring paper jams?](#)
- [Clear jams in the Main input tray](#)
- [Clear jams in the toner-cartridge area](#)
- [Clear jams in the output bin](#)
- [Clear jams in the duplexer](#)

## Jam locations

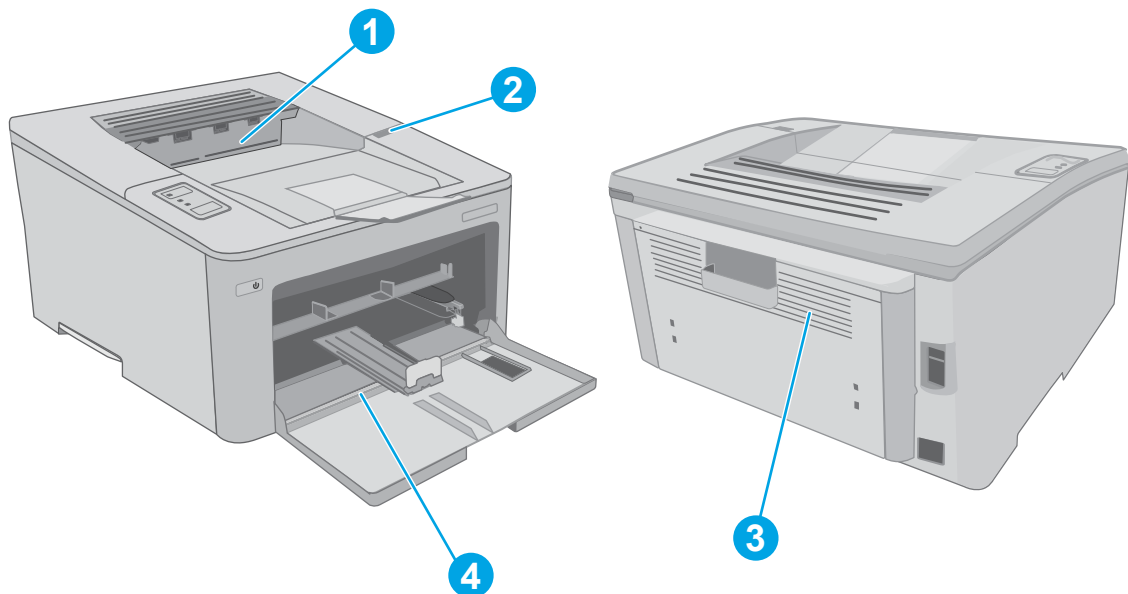



1	Output bin
2	Cartridge area
3	Duplexer
4	Main input tray

## Experiencing frequent or recurring paper jams?

Follow these steps to solve problems with frequent paper jams. If the first step does not resolve the problem continue with the next step until you have resolved the problem.

1. If paper has jammed in the printer, clear the jam and then print a configuration page to test the printer.
2. Check that the tray is configured for the correct paper size and type. Adjust paper settings if necessary.



a. Print a configuration page to determine the IP address or host name.

- i. Press and hold the Resume  button until the Ready  light begins blinking.
- ii. Release the Resume  button.

b. Open a web browser, and in the address line, type the IP address or host name exactly as it displays on the printer configuration page. Press the **Enter** key on the computer keyboard. The EWS opens.

 <https://10.10.XXXX/>

 **NOTE:** If the displays a message indicating that accessing the website might not be safe, select the option to continue to the website. Accessing this website will not harm the computer.

- c. Click the **System** tab, and then click the **Paper Setup** page.
  - d. Select the type of paper that is in the tray.
  - e. Select the size of paper that is in the tray.
3. Turn the printer off, wait 30 seconds, and then turn it on again.
  4. Print a cleaning page to remove excess toner from inside the printer.
    - a. Open the HP Printer Assistant.
      - **Windows 10:** From the **Start** menu, click **All Apps**, click **HP**, and then select the printer name.
      - **Windows 8.1:** Click the down arrow in lower left corner of the **Start** screen, and then select the printer name.
      - **Windows 8:** Right-click an empty area on the **Start** screen, click **All Apps** on the app bar, and then select the printer name.
      - **Windows 7, Windows Vista, and Windows XP:** From the computer desktop, click **Start**, select **All Programs**, click **HP**, click the folder for the printer, and then select the printer name.
    - b. In the HP Printer Assistant, select **Print**, and then select **HP Device Toolbox**.
    - c. On the **Systems** tab, click **Service**.
    - d. In the **Cleaning Mode** area, click **Start** to begin the cleaning process.
  5. Print a configuration page to test the printer.
    - a. Press and hold the Resume  button until the Ready  light begins blinking.
    - b. Release the Resume  button.

If none of these steps resolves the problem, the printer might need service. Contact HP customer support.

## Clear jams in the Main input tray

Use the following procedure to check for paper in all possible jam locations in the Main input tray. When a jam occurs, the Attention  LED flashes.

1. Slowly pull the jammed paper out of the printer.

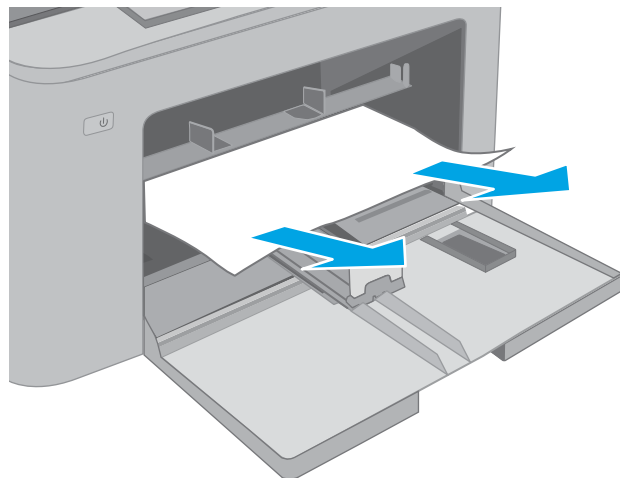

2. Open the cartridge door.

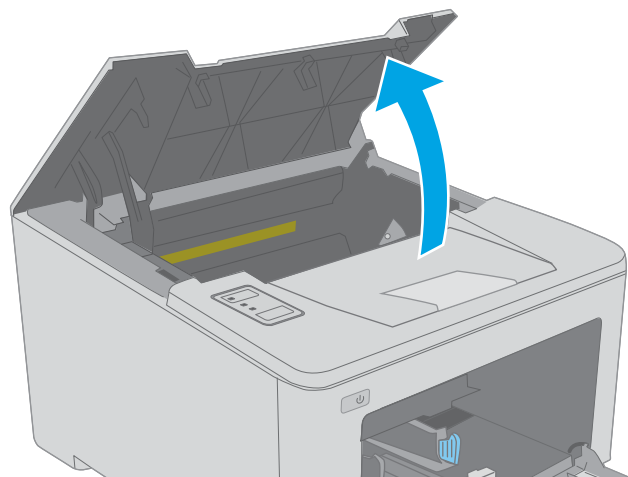

3. Remove the toner cartridge from the printer.

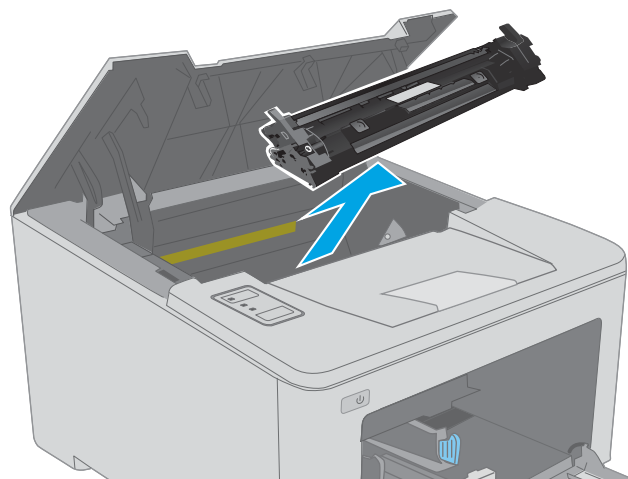

4. Remove the imaging drum from the printer.

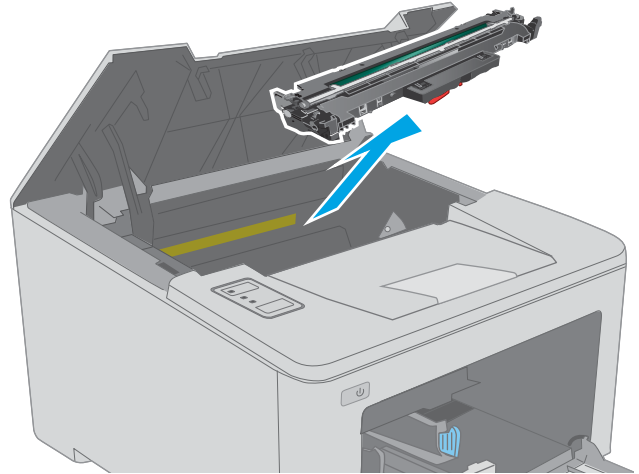

5. Remove any jammed paper from the toner-cartridge area. Use both hands to remove jammed paper to avoid tearing the paper.

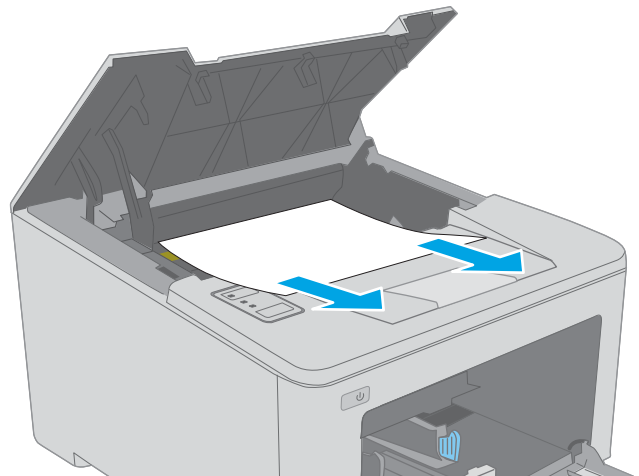

6. Lower the jam-access cover.

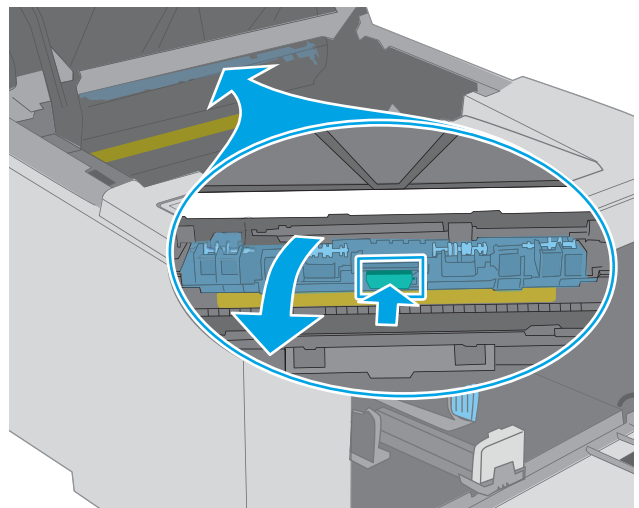

7. Remove any jammed paper.

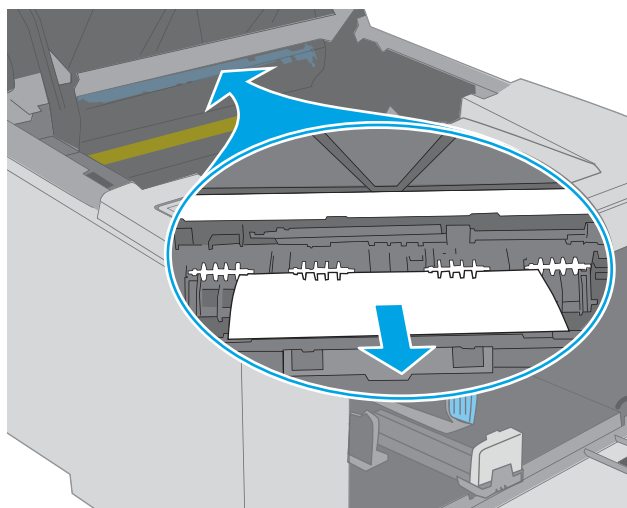

8. Close the jam-access cover.

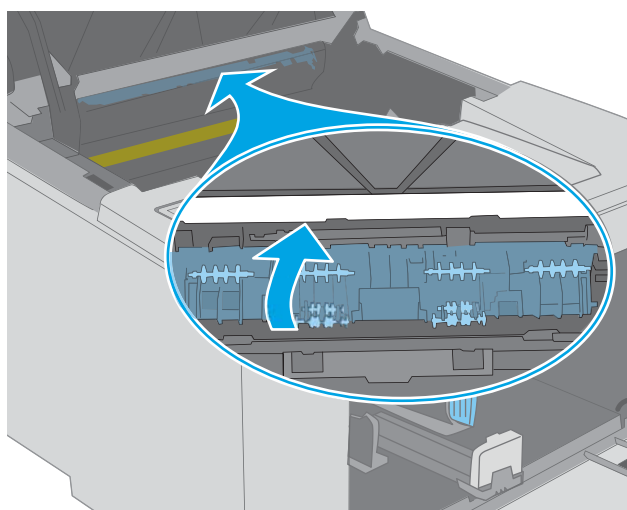

9. Align the imaging drum with the tracks inside the printer, and install the imaging drum until it is firmly seated.

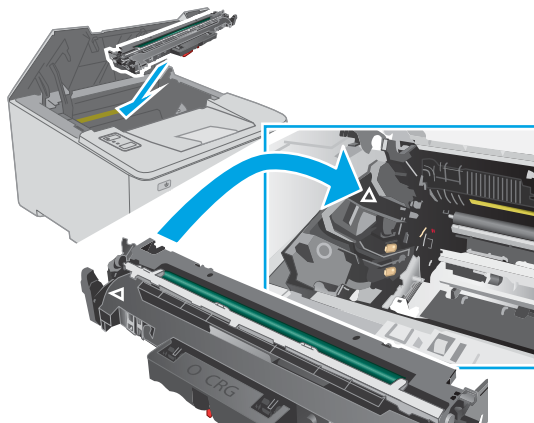

10. Align the toner cartridge with the tracks inside the printer, and install the toner cartridge until it is firmly seated.

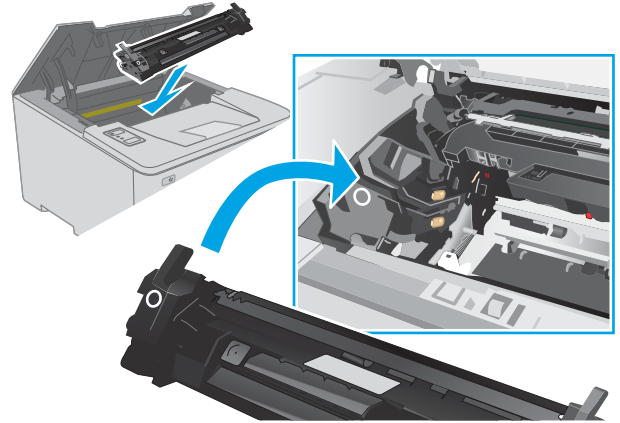

11. Close the cartridge door.

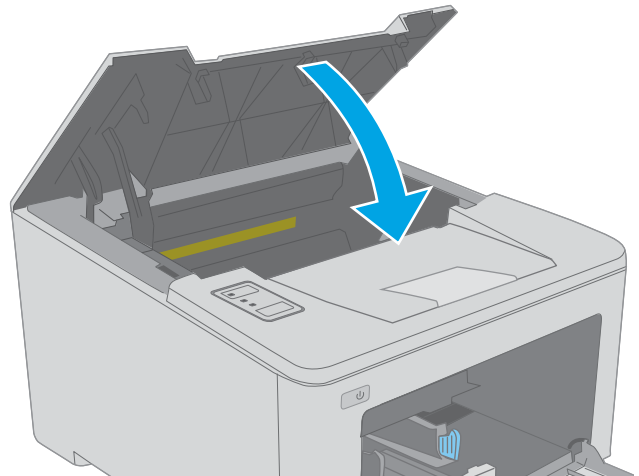



## Clear jams in the toner-cartridge area

The following information describes how to clear paper jams in the toner-cartridge area. When a jam occurs, the Attention  LED flashes.

1. Open the cartridge door.

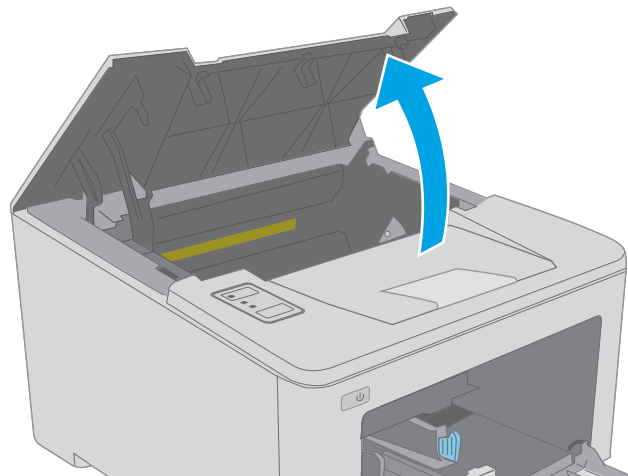

2. Remove the toner cartridge from the printer.

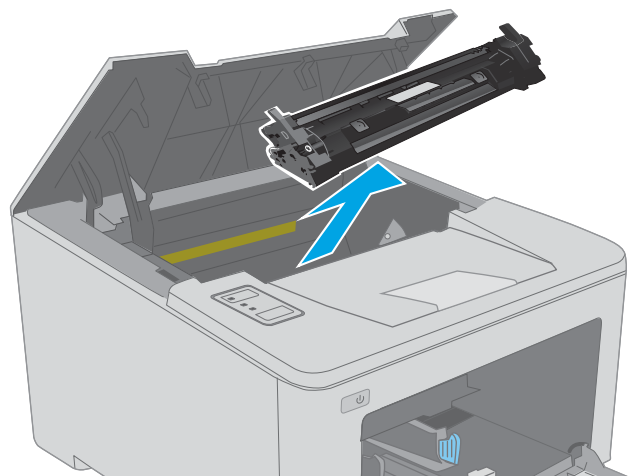

3. Remove the imaging drum from the printer.

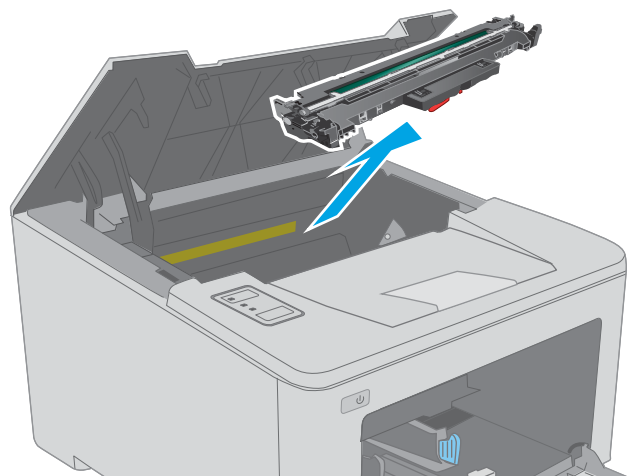

4. Remove any jammed paper from the toner-cartridge area. Use both hands to remove jammed paper to avoid tearing the paper.

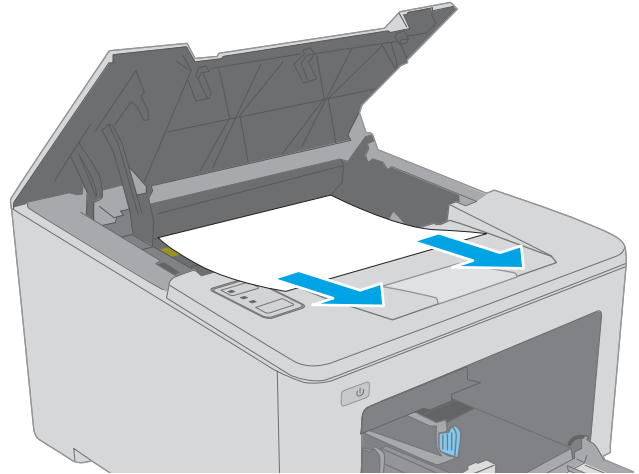

5. Lower the jam-access cover.

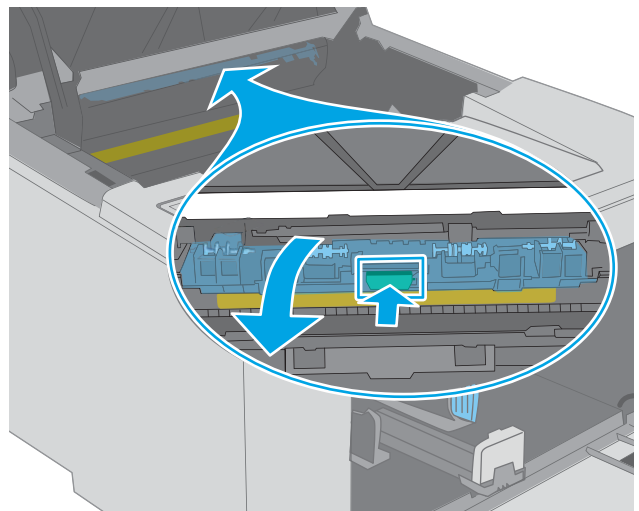

6. Remove any jammed paper.

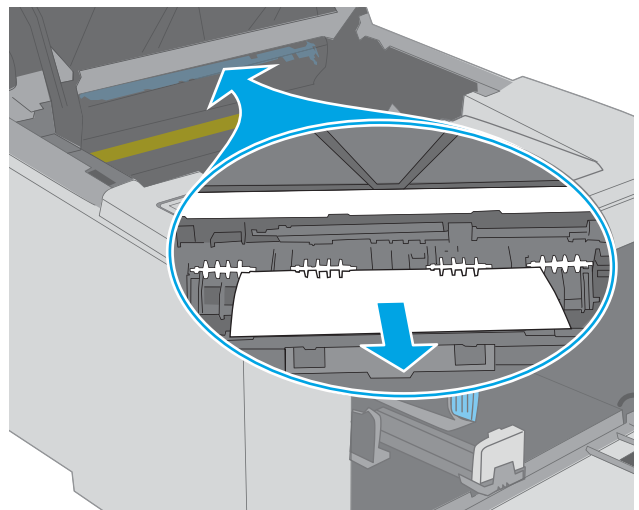

7. Close the jam-access cover.

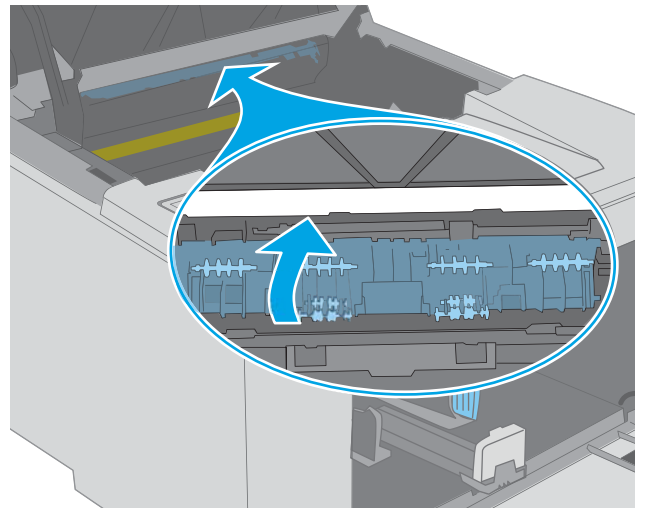

8. Align the imaging drum with the tracks inside the printer, and install the imaging drum until it is firmly seated.

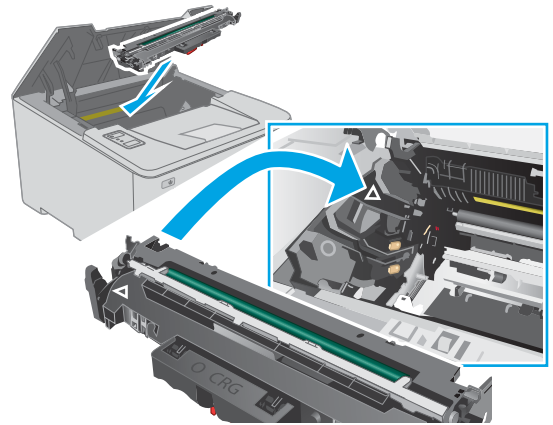

9. Align the toner cartridge with the tracks inside the printer, and install the toner cartridge until it is firmly seated.

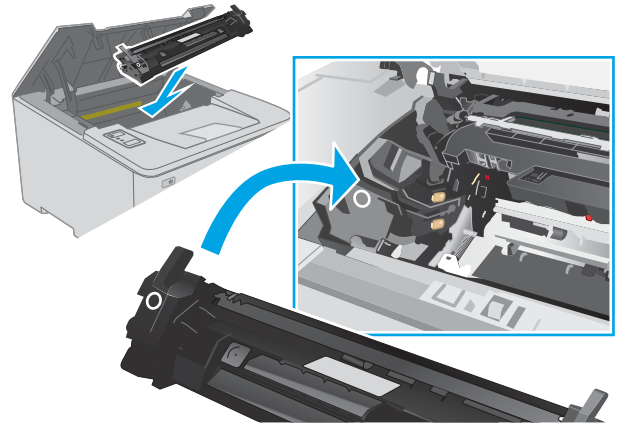

10. Close the cartridge door.

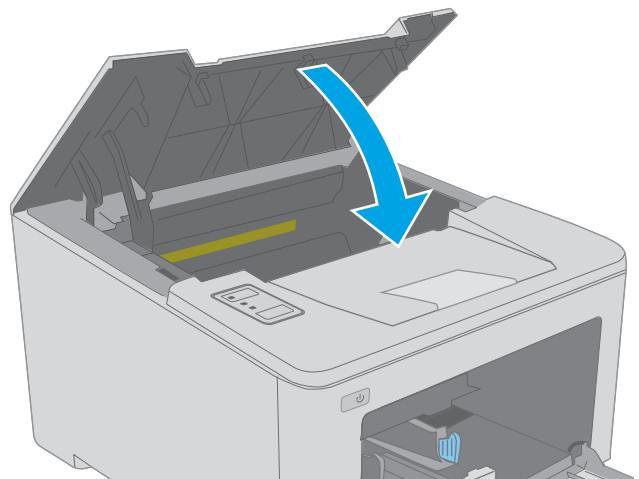

## Clear jams in the output bin

Use the following procedure to check for paper in all possible jam locations in the output bin. When a jam occurs, the Attention  LED flashes.

1. If paper is visible in the output bin, grasp the leading edge and remove it.

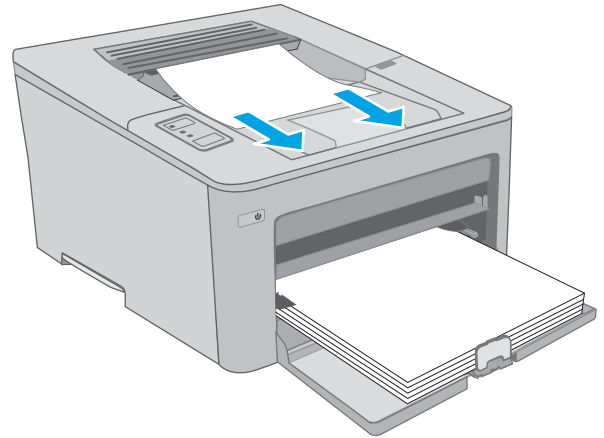

2. Open the cartridge door.

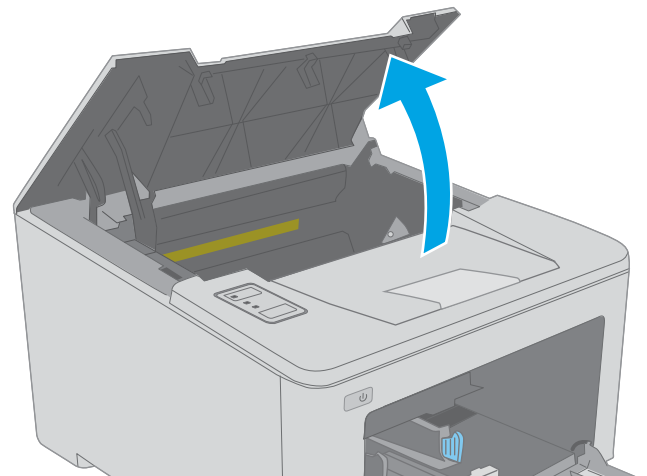

3. Pull out the green tab to release the jam-access cover.

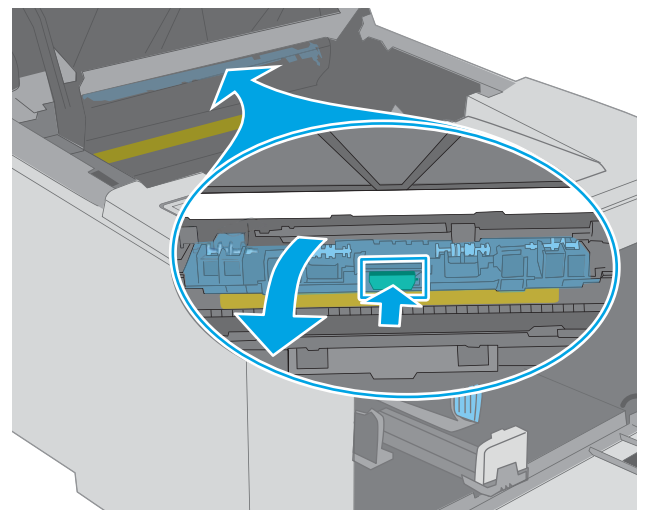

4. Remove any jammed paper.

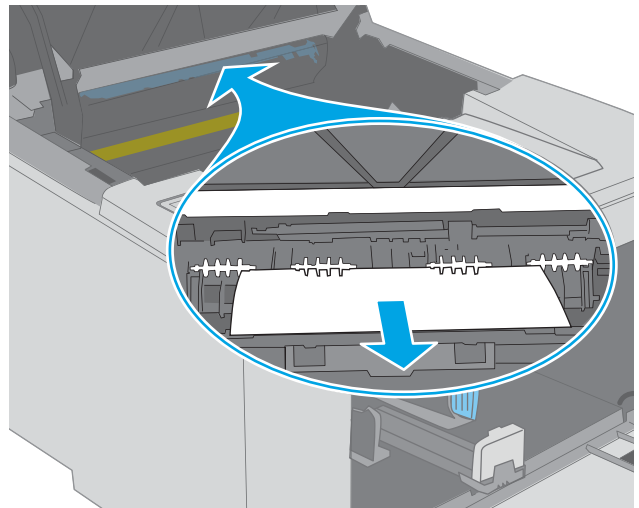

5. Close the jam-access cover.

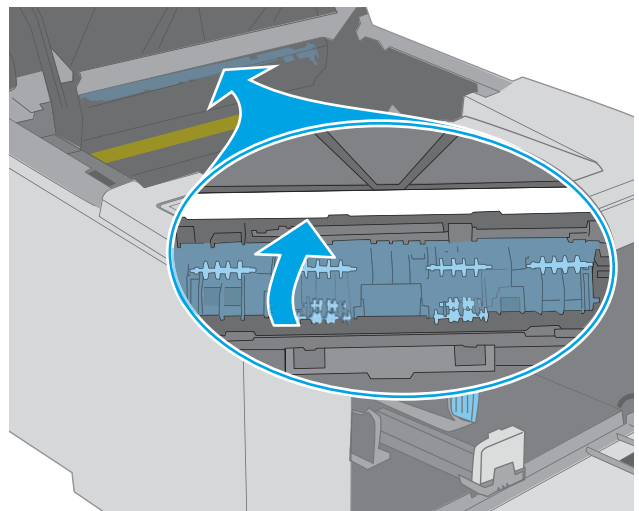

6. Close the cartridge door.

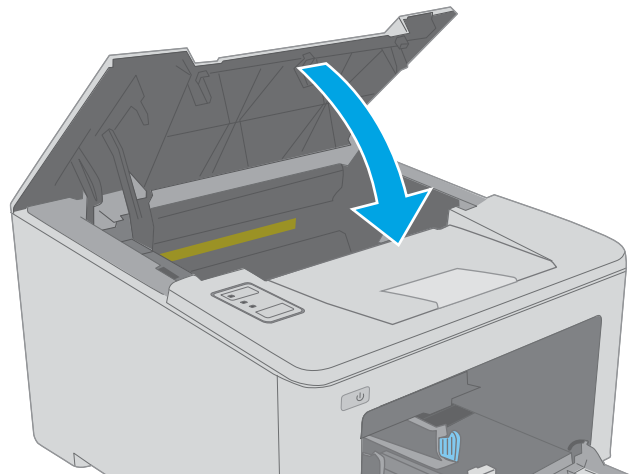

## Clear jams in the duplexer

Use the following procedure to check for paper in all possible jam locations in the duplexer. When a jam occurs, the Attention  LED flashes.

1. Open the rear door.

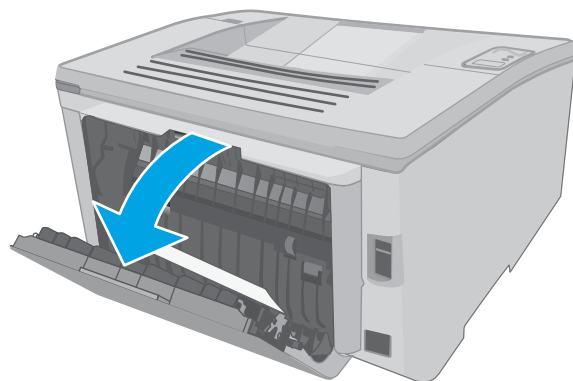

2. Remove any jammed paper from the duplex area. Use both hands to remove jammed paper to avoid tearing the paper.

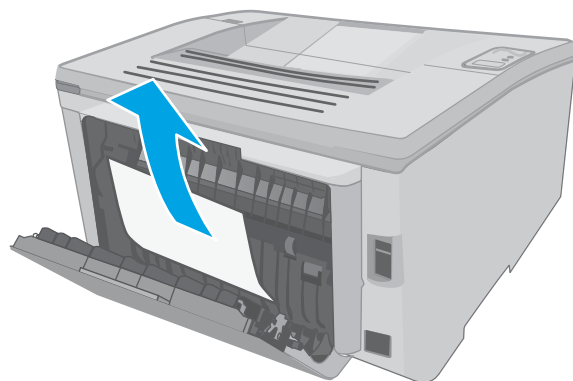

3. Close the rear door.

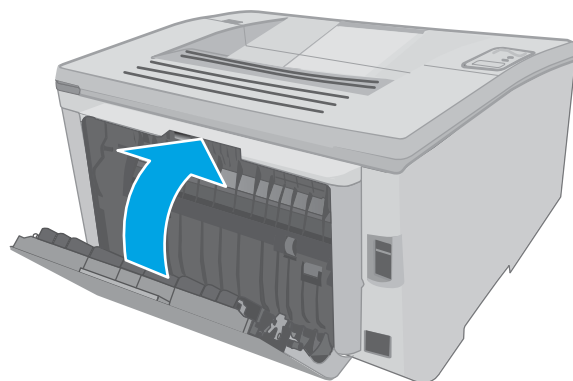

4. Open the cartridge door.

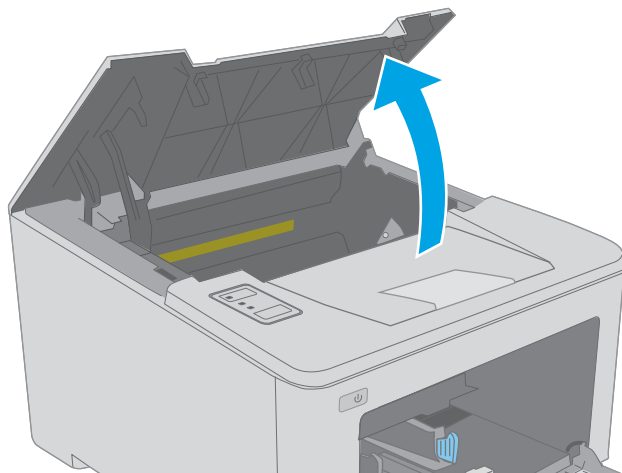

5. Pull out the green tab to release the jam-access cover.

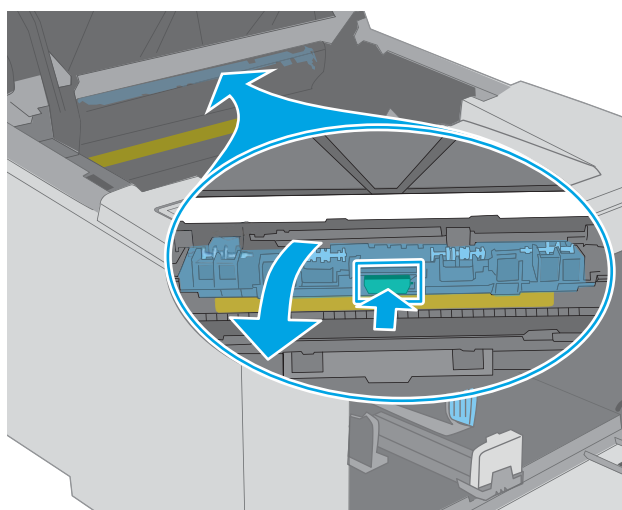

6. Remove any jammed paper.

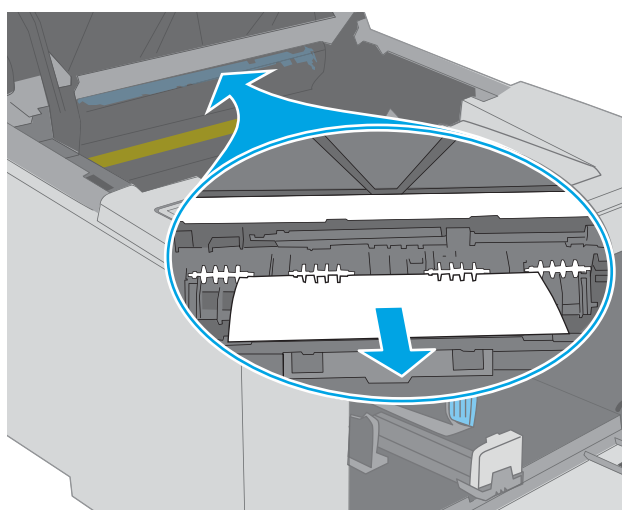



7. Close the jam-access cover.

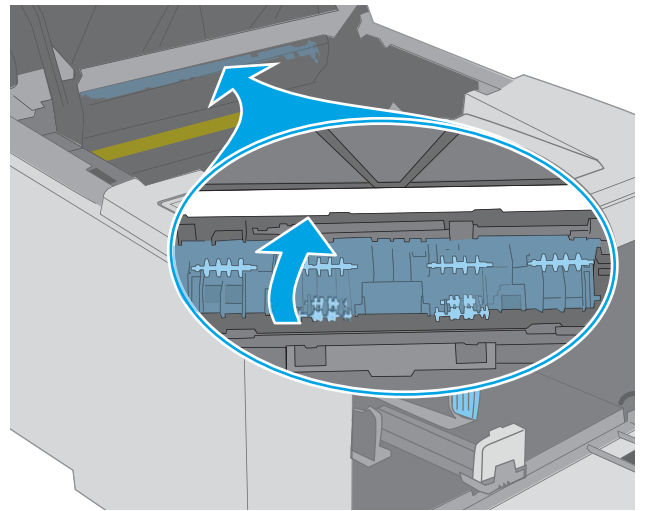

8. Close the cartridge door.

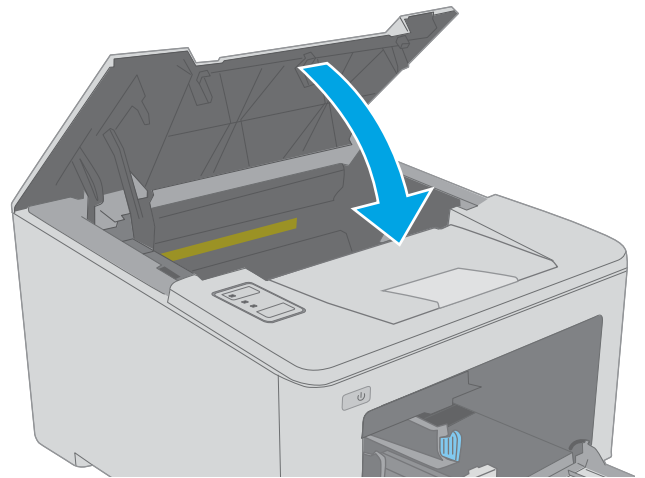

# Improve print quality

- [Introduction](#)
- [Print from a different software program](#)
- [Check the paper-type setting for the print job](#)
- [Check toner-cartridge status](#)
- [Clean the printer](#)
- [Visually inspect the toner cartridge and imaging drum](#)
- [Check paper and the printing environment](#)
- [Try a different print driver](#)
- [Check the EconoMode settings](#)
- [Adjust Print Density](#)

## Introduction

If the printer is having print-quality problems, try the following solutions in the order presented to resolve the issue.

## Print from a different software program

Try printing from a different software program. If the page prints correctly, the problem is with the software program from which you were printing.

## Check the paper-type setting for the print job

Check the paper type setting when printing from a software program and the printed pages have smears, fuzzy or dark print, curled paper, scattered dots of toner, loose toner, or small areas of missing toner.

## Check the paper type setting (Windows)

1. From the software program, select the **Print** option.
2. Select the printer, and then click the **Properties** or **Preferences** button.
3. Click the **Paper/Quality** tab.
4. From the **Paper Type** drop-down list, click the **More...** option.
5. Expand the list of **Type is:** options.
6. Expand the category of paper types that best describes your paper.
7. Select the option for the type of paper you are using, and click the **OK** button.
8. Click the **OK** button to close the **Document Properties** dialog box. In the **Print** dialog box, click the **OK** button to print the job.

## Check the paper type setting (OS X)



1. Click the **File** menu, and then click the **Print** option.
2. In the **Printer** menu, select the printer.
3. By default, the print driver displays the **Copies & Pages** menu. Open the menus drop-down list, and then click the **Finishing** menu.
4. Select a type from the **Media Type** drop-down list.
5. Click the **Print** button.

## Check toner-cartridge status

Check the supplies status page for the following information:

- Estimated percentage of cartridge life remaining
- Approximate pages remaining
- Part numbers for HP toner cartridges
- Number of pages printed

The printer prints the supplies status page when it prints the configuration page.

1. Press and hold the Resume  button until the Ready  light begins blinking.
2. Release the Resume  button.

## Clean the printer

### Print a cleaning page

1. Open the HP Printer Assistant.
  - **Windows 10:** From the **Start** menu, click **All Apps**, click **HP**, and then select the printer name.
  - **Windows 8.1:** Click the down arrow in lower left corner of the **Start** screen, and then select the printer name.
  - **Windows 8:** Right-click an empty area on the **Start** screen, click **All Apps** on the app bar, and then select the printer name.
  - **Windows 7, Windows Vista, and Windows XP:** From the computer desktop, click **Start**, select **All Programs**, click **HP**, click the folder for the printer, and then select the printer name.
2. In the HP Printer Assistant, select **Print**, and then select **HP Device Toolbox**.
3. On the **Systems** tab, click **Service**.
4. In the **Cleaning Mode** area, click **Start** to begin the cleaning process.

## Visually inspect the toner cartridge and imaging drum

Follow these steps to inspect each toner cartridge and imaging drum.

1. Remove the toner cartridge and imaging drum from the printer.
2. Check the memory chip for damage.
3. Examine the surface of the green imaging drum.

---

 **CAUTION:** Do not touch the imaging drum. Fingerprints on the imaging drum can cause print-quality problems.

---

4. If you see any scratches, fingerprints, or other damage on the imaging drum, replace the toner cartridge and imaging drum.
5. Reinstall the toner cartridge and imaging drum, and print a few pages to see if the problem has resolved.

## Check paper and the printing environment

### Step one: Use paper that meets HP specifications

Some print-quality problems arise from using paper that does not meet HP specifications.

- Always use a paper type and weight that this printer supports.
- Use paper that is of good quality and free of cuts, nicks, tears, spots, loose particles, dust, wrinkles, voids, staples, and curled or bent edges.
- Use paper that has not been previously printed on.
- Use paper that does not contain metallic material, such as glitter.
- Use paper that is designed for use in laser printers. Do not use paper that is designed only for use in Inkjet printers.
- Use paper that is not too rough. Using smoother paper generally results in better print quality.

### Step two: Check the environment

The environment can directly affect print quality and is a common cause for print-quality or paper-feeding issues. Try the following solutions:

- Move the printer away from drafty locations, such as open windows or doors, or air-conditioning vents.
- Make sure the printer is not exposed to temperatures or humidity outside of printer specifications.
- Do not place the printer in a confined space, such as a cabinet.
- Place the printer on a sturdy, level surface.
- Remove anything that is blocking the vents on the printer. The printer requires good air flow on all sides, including the top.
- Protect the printer from airborne debris, dust, steam, grease, or other elements that can leave residue inside the printer.

## Step three: Set the individual tray alignment



Follow these steps when text or images are not centered or aligned correctly on the printed page when printing from specific trays.

1. Open the HP Embedded Web Server (EWS):

### Direct-connected printers

- a. Open the HP Printer Assistant.
  - **Windows 10:** From the **Start** menu, click **All Apps**, click **HP**, and then select the printer name.
  - **Windows 8.1:** Click the down arrow in lower left corner of the **Start** screen, and then select the printer name.
  - **Windows 8:** Right-click an empty area on the **Start** screen, click **All Apps** on the app bar, and then select the printer name.
  - **Windows 7, Windows Vista, and Windows XP:** From the computer desktop, click **Start**, select **All Programs**, click **HP**, click the folder for the printer, and then select the printer name.
- b. In the HP Printer Assistant, select **Print**, and then select **HP Device Toolbox**.

### Network-connected printers

- a. Print a configuration page to determine the IP address or host name.
  - i. Press and hold the Resume  button until the Ready  light begins blinking.
  - ii. Release the Resume  button.
- b. Open a web browser, and in the address line, type the IP address or host name exactly as it displays on the printer configuration page. Press the **Enter** key on the computer keyboard. The EWS opens.

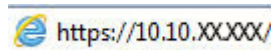

 **NOTE:** If the displays a message indicating that accessing the website might not be safe, select the option to continue to the website. Accessing this website will not harm the computer.

2. Click the **System** tab, and then select the **Service** page.
3. In the **Adjust Alignment** area, select the tray to adjust.
4. Select one of the following options:
  - X1 shift
  - X2 shift
  - Y shift
5. Adjust the alignment settings, and then click **Apply**
6. Click **Print Test Page** to print a test page in order to confirm the new alignment settings.

## Try a different print driver

Try a different print driver when printing from a software program and the printed pages have unexpected lines in graphics, missing text, missing graphics, incorrect formatting, or substituted fonts.

Download any of the following drivers from the HP Web site: [www.hp.com/support/ljM118](http://www.hp.com/support/ljM118), [www.hp.com/support/ljM203](http://www.hp.com/support/ljM203).

<b>HP PCL6 driver</b>	If available, this printer-specific print driver supports older operating systems like Windows® XP and Windows Vista®. For a list of supported operating systems, go to <a href="http://www.hp.com/go/support">www.hp.com/go/support</a> .
<b>HP PCL 6 driver</b>	This printer-specific print driver supports Windows 7 and newer operating systems that support version 3 drivers. For a list of supported operating systems, go to <a href="http://www.hp.com/go/support">www.hp.com/go/support</a> .
<b>HP PCL-6 driver</b>	This product-specific print driver supports Windows 8 and newer operating systems that support version 4 drivers. For a list of supported operating systems, go to <a href="http://www.hp.com/go/support">www.hp.com/go/support</a> .
<b>HP UPD PS driver</b>	<ul style="list-style-type: none"><li>• Recommended for printing with Adobe® software programs or with other highly graphics-intensive software programs</li><li>• Provides support for printing from postscript emulation needs, or for postscript flash font support</li></ul>
<b>HP UPD PCL 6</b>	<ul style="list-style-type: none"><li>• Recommended for printing in all Windows environments</li><li>• Provides the overall best speed, print quality, and printer feature support for most users</li><li>• Developed to align with Windows Graphic Device Interface (GDI) for best speed in Windows environments</li><li>• Might not be fully compatible with third-party and custom software programs that are based on PCL 5</li></ul>

## Check the EconoMode settings

HP does not recommend the full-time use of EconoMode. If EconoMode is used full-time, the toner supply might outlast the mechanical parts in the toner cartridge. If print quality begins to degrade and is no longer acceptable, consider replacing the toner cartridge.

---

 **NOTE:** This feature is available with the PCL 6 print driver for Windows. If you are not using that driver, you can enable the feature by using the HP Embedded Web Server.

---

Follow these steps if the entire page is too dark or too light.



1. From the software program, select the **Print** option.
2. Select the printer, and then click the **Properties** or **Preferences** button.
3. Click the **Paper/Quality** tab, and locate the **Print Quality** area.
4. If the entire page is too dark, use these settings:
  - Select the **600 dpi** option.
  - Select the **EconoMode** check box to enable it.

If the entire page is too light, use these settings:

- Select the **FastRes 1200** option.
  - Clear the **EconoMode** check box to disable it.
5. Click the **OK** button to close the **Document Properties** dialog box. In the **Print** dialog, click the **OK** button to print the job.

## Adjust Print Density

Complete the following steps to adjust the print density.

1. Open the HP Embedded Web Server (EWS):
  - a. Print a configuration page to determine the IP address or host name.
    - i. Press and hold the Resume  button until the Ready  light begins blinking.
    - ii. Release the Resume  button.
  - b. Open a web browser, and in the address line, type the IP address or host name exactly as it displays on the printer configuration page. Press the **Enter** key on the computer keyboard. The EWS opens.

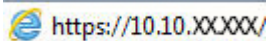

---

 **NOTE:** If the displays a message indicating that accessing the website might not be safe, select the option to continue to the website. Accessing this website will not harm the computer.

---

2. Click the **System** tab, and then click the **Print Quality** page.
3. From the **Print Density**: drop-down, select the correct density setting.

---

 **NOTE:** The default print density setting is **3**.

---

- 1 (Light)
- 2
- 3
- 4
- 5 (Dark)

4. Click **Apply**.



# Solve wired network problems

## Introduction

Check the following items to verify that the printer is communicating with the network. Before beginning, print a configuration page from the printer control panel and locate the printer IP address that is listed on this page.

- [Poor physical connection](#)
- [The computer is using the incorrect IP address for the printer](#)
- [The computer is unable to communicate with the printer](#)
- [The printer is using incorrect link speed and duplex settings for the network](#)
- [New software programs might be causing compatibility problems](#)
- [The computer or workstation might be set up incorrectly](#)
- [The printer is disabled, or other network settings are incorrect](#)



**NOTE:** HP does not support peer-to-peer networking, as the feature is a function of Microsoft operating systems and not of the HP print drivers. For more information, go to Microsoft at [www.microsoft.com](http://www.microsoft.com).

## Poor physical connection

1. Verify that the printer is attached to the correct network port using a cable of the correct length.
2. Verify that cable connections are secure.
3. Look at the network port connection on the back of the printer, and verify that the amber activity light and the green link-status light are lit.
4. If the problem continues, try a different cable or port on the hub.

## The computer is using the incorrect IP address for the printer

1. Open the printer properties and click the **Ports** tab. Verify that the current IP address for the printer is selected. The printer IP address is listed on the printer configuration page.
2. If you installed the printer using the HP standard TCP/IP port, select the box labeled **Always print to this printer, even if its IP address changes**.
3. If you installed the printer using a Microsoft standard TCP/IP port, use the hostname instead of the IP address.
4. If the IP address is correct, delete the printer and then add it again.

## The computer is unable to communicate with the printer

1. Test network communication by pinging the network.
  - a. Open a command-line prompt on your computer.

- For Windows, click **Start**, click **Run**, type `cmd`, and then press **Enter**.
  - For OS X, go to **Applications**, then **Utilities**, and open **Terminal**.
- b. Type `ping` followed by the IP address for your printer.
  - c. If the window displays round-trip times, the network is working.
2. If the ping command failed, verify that the network hubs are on, and then verify that the network settings, the printer, and the computer are all configured for the same network.

## The printer is using incorrect link speed and duplex settings for the network

HP recommends leaving these settings in automatic mode (the default setting). If you change these settings, you must also change them for your network.

## New software programs might be causing compatibility problems

Verify that any new software programs are correctly installed and that they use the correct print driver.

## The computer or workstation might be set up incorrectly

1. Check the network drivers, print drivers, and the network redirection settings.
2. Verify that the operating system is configured correctly.

## The printer is disabled, or other network settings are incorrect

1. Review the configuration page to check the status of the network protocol. Enable it if necessary.
2. Reconfigure the network settings if necessary.

# Solve wireless network problems

- [Introduction](#)
- [Wireless connectivity checklist](#)
- [The printer does not print after the wireless configuration completes](#)
- [The printer does not print, and the computer has a third-party firewall installed](#)
- [The wireless connection does not work after moving the wireless router or printer](#)
- [Cannot connect more computers to the wireless printer](#)
- [The wireless printer loses communication when connected to a VPN](#)
- [The network does not appear in the wireless networks list](#)
- [The wireless network is not functioning](#)
- [Perform a wireless network diagnostic test](#)
- [Reduce interference on a wireless network](#)

## Introduction

Use the troubleshooting information to help resolve issues.

---

 **NOTE:** To determine whether HP NFC and Wi-Fi Direct printing are enabled on your printer, print a configuration page from the printer control panel

---

## Wireless connectivity checklist

- Verify that the network cable is not connected.
- Verify that the printer and the wireless router are turned on and have power. Also make sure that the wireless radio in the printer is turned on.
- Verify that the service set identifier (SSID) is correct. Print a configuration page to determine the SSID. If you are not sure the SSID is correct, run the wireless setup again.
- With secured networks, verify that the security information is correct. If the security information is incorrect, run the wireless setup again.
- If the wireless network is working correctly, try accessing other computers on the wireless network. If the network has Internet access, try connecting to the Internet over a wireless connection.
- Verify that the encryption method (AES or TKIP) is the same for the printer as it is for the wireless access point (on networks using WPA security).
- Verify that the printer is within the range of the wireless network. For most networks, the printer must be within 30 m (100 ft) of the wireless access point (wireless router).
- Verify that obstacles do not block the wireless signal. Remove any large metal objects between the access point and the printer. Make sure poles, walls, or support columns containing metal or concrete do not separate the printer and wireless access point.

- Verify that the printer is located away from electronic devices that might interfere with the wireless signal. Many devices can interfere with the wireless signal including motors, cordless phones, security system cameras, other wireless networks, and some Bluetooth devices.
- Verify that the print driver is installed on the computer.
- Verify that you have selected the correct printer port.
- Verify that the computer and printer connect to the same wireless network.
- For OS X, verify that the wireless router supports Bonjour.

## The printer does not print after the wireless configuration completes

1. Make sure that the printer is turned on and in the ready state.
2. Turn off any third-party firewalls on your computer.
3. Make sure that the wireless network is working correctly.
4. Make sure that your computer is working correctly. If necessary, restart the computer.
5. Verify that you can open the printer HP Embedded Web Server from a computer on the network.

## The printer does not print, and the computer has a third-party firewall installed

1. Update the firewall with the most recent update available from the manufacturer.
2. If programs request firewall access when you install the printer or try to print, make sure you allow the programs to run.
3. Temporarily turn off the firewall, and then install the wireless printer on the computer. Enable the firewall when you have completed the wireless installation.

## The wireless connection does not work after moving the wireless router or printer

1. Make sure that the router or printer connects to the same network that your computer connects to.
2. Print a configuration page.
3. Compare the service set identifier (SSID) on the configuration page to the SSID in the printer configuration for the computer.
4. If the numbers are not the same, the devices are not connecting to the same network. Reconfigure the wireless setup for the printer.

## Cannot connect more computers to the wireless printer

1. Make sure that the other computers are within the wireless range and that no obstacles block the signal. For most networks, the wireless range is within 30 m (100 ft) of the wireless access point.
2. Make sure that the printer is turned on and in the ready state.
3. Make sure there are not more than 5 concurrent Wi-Fi Direct users.
4. Turn off any third-party firewalls on your computer.

5. Make sure that the wireless network is working correctly.
6. Make sure that your computer is working correctly. If necessary, restart the computer.

## The wireless printer loses communication when connected to a VPN

- Typically, you cannot connect to a VPN and other networks at the same time.

## The network does not appear in the wireless networks list



- Make sure the wireless router is turned on and has power.
- The network might be hidden. However, you can still connect to a hidden network.

## The wireless network is not functioning

1. Make sure that the network cable is not connected.
2. To verify if the network has lost communication, try connecting other devices to the network.
3. Test network communication by pinging the network.
  - a. Open a command-line prompt on your computer.
    - For Windows, click **Start**, click **Run**, type `cmd`, and then press [Enter](#).
    - For OS X, go to **Applications**, then **Utilities**, and open **Terminal**.
  - b. Type `ping` followed by the router IP address.
  - c. If the window displays round-trip times, the network is working.
4. Make sure that the router or printer connects to the same network that the computer connects to.
  - a. Print a configuration page.
  - b. Compare the service set identifier (SSID) on the configuration report to the SSID in the printer configuration for the computer.
  - c. If the numbers are not the same, the devices are not connecting to the same network. Reconfigure the wireless setup for the printer.

## Perform a wireless network diagnostic test

From the printer control panel, you can run a diagnostic test that provides information about the wireless network settings.

1. Open the HP Embedded Web Server (EWS):
  - a. Print a configuration page to determine the IP address or host name.
    - i. Press and hold the Resume  button until the Ready  light begins blinking.
    - ii. Release the Resume  button.

- b. Open a web browser, and in the address line, type the IP address or host name exactly as it displays on the printer configuration page. Press the **Enter** key on the computer keyboard. The EWS opens.

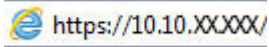

 **NOTE:** If the displays a message indicating that accessing the website might not be safe, select the option to continue to the website. Accessing this website will not harm the computer.

2. Select the **Networking** tab.
3. On the **Wireless Configuration** page, verify that the On option is selected.
4. Click the **Print Test Report** button to print a test page that shows test results.

## Reduce interference on a wireless network

The following tips can reduce interference in a wireless network:

- Keep the wireless devices away from large metal objects, such as filing cabinets, and other electromagnetic devices, such as microwaves and cordless telephones. These objects can disrupt radio signals.
- Keep the wireless devices away from large masonry structures and other building structures. These objects can absorb radio waves and lower signal strength.
- Position the wireless router in a central location in line of sight with the wireless printers on the network.

# Index

## A

- accessories
  - ordering 24
  - part numbers 24
- acoustic specifications 8
- AirPrint 49
- Android devices
  - printing from 49

## B

- bin, output
  - locating 2
- browser requirements
  - HP Embedded Web Server 53

## C

- cartridge policy 25
- checklist
  - wireless connectivity 105
- cleaning
  - paper path 97
- control panel
  - LED light patterns 71
  - locating 2
- customer support
  - online 70

## D

- defaults, restoring 74
- dimensions, printer 7
- double-sided printing
  - Mac 42
  - Windows 39
- drivers, supported 5
- duplex printing
  - Mac 42
- duplex printing (double-sided)
  - settings (Windows) 38
  - Windows 39

- duplexer
  - locating 3
- duplexing
  - manually (Mac) 42
  - manually (Windows) 39

## E

- EconoMode setting 64, 101
- economy settings 64
- electrical specifications 8
- Embedded Web Server
  - changing password 61
  - opening 61
- Embedded Web Server (EWS)
  - features 53
- envelope
  - orientation 19
- envelopes, loading 19
- Explorer, versions supported
  - HP Embedded Web Server 53

## F

- factory-set defaults, restoring 74

## G

- genuine HP cartridges 25

## H

- HP Customer Care 70
- HP Device Toolbox, using 53
- HP Embedded Web Server
  - changing password 61
  - opening 61
- HP Embedded Web Server (EWS)
  - features 53
- HP ePrint 48
- HP ePrint software 48
- HP EWS, using 53
- HP Utility 56

- HP Utility for Mac
  - Bonjour 56
  - features 56
- HP Utility, Mac 56

## I

- interface ports
  - locating 3
- Internet Explorer, versions supported
  - HP Embedded Web Server 53

## J

- jams
  - locating 80

## L

- label
  - orientation 21
- labels
  - printing (Windows) 40
  - printing on 21
- labels, loading 21
- lock
  - formatter 62

## M

- Macintosh
  - HP Utility 56
- Main input tray
  - loading 15
  - loading envelopes 19
  - loading labels 21
  - orientation 15
- manual duplex
  - Mac 42
  - Windows 39
- memory
  - included 5

- mobile printing
  - Android devices 49
- mobile printing solutions 5
- mobile printing, software supported 7
- multiple pages per sheet
  - printing (Mac) 43
  - printing (Windows) 39

**N**

- Netscape Navigator, versions supported
  - HP Embedded Web Server 53
- network
  - password, changing 61
  - password, setting 61
- network duplex settings, changing 60
- network installation 52
- network link speed settings, changing 60
- network port
  - locating 3
- networks
  - installing the printer 52
  - supported 5

**O**

- on/off button, locating 2
- online support 70
- operating systems (OS)
  - supported 5
- operating systems, supported 5
- ordering
  - supplies and accessories 24
- OS (operating system)
  - supported 5
- output bin
  - locating 2

**P**

- pages per minute 5
- pages per sheet
  - selecting (Mac) 43
  - selecting (Windows) 39
- paper
  - selecting 98
- paper pickup problems
  - solving 77, 78
- paper type
  - selecting (Windows) 40

- paper types
  - selecting (Mac) 43
- paper, ordering 24
- part numbers
  - accessories 24
  - supplies 24
  - toner cartridges 24
- power
  - consumption 8
- power connection
  - locating 3
- power switch, locating 2
- power-down delay
  - setting 66
- print drivers, supported 5
- print on both sides
  - Mac 42
  - manually, Windows 39
  - Windows 39
- printing on both sides
  - settings (Windows) 38
- Priority input tray
  - loading 12
  - loading envelopes 19
  - loading labels 21
  - orientation 12

**R**

- rear door
  - locating 3
- restoring factory-set defaults 74

**S**

- settings
  - factory-set defaults, restoring 74
- shut down after delay
  - setting 65
- sleep delay
  - disabling 64
  - enabling 64
- software
  - HP Utility 56
- special paper
  - printing (Windows) 40
- specifications
  - electrical and acoustic 8
- status
  - control panel lights 71
  - HP Utility, Mac 56

- supplies
  - low threshold settings 75
  - ordering 24
  - part numbers 24
  - status, viewing with HP Utility for Mac 56
  - using when low 75
- supplies status 97
- support
  - online 70
- system requirements
  - HP Embedded Web Server 53

**T**

- technical support
  - online 70
- toner cartridge
  - low threshold settings 75
  - using when low 75
- toner cartridges
  - part numbers 24
- toner-cartridge status 97
- transparencies
  - printing (Windows) 40
- trays
  - capacity 5
  - included 5
  - locating 2
- troubleshooting
  - LED, errors 71
  - LED, light patterns 71
  - network problems 103
  - paper feed problems 77
  - wired network 103
  - wireless network 105
- two-sided printing
  - settings (Windows) 38

**U**

- USB port
  - locating 3

**W**

- walk-up USB port
  - locating 2
- web browser requirements
  - HP Embedded Web Server 53
- Web sites
  - customer support 70
- weight, printer 7
- Wi-Fi Direct printing 7, 45



wireless network  
troubleshooting 105  
wireless network interference 108

