

**Nikon**

DIGITAL CAMERA

**D610**

---

User's Manual

En

Thank you for your purchase of a Nikon single-lens reflex (SLR) digital camera. To get the most from your camera, please be sure to read all instructions thoroughly and keep them where they will be read by all who use the product.

### **Symbols and Conventions**

To make it easier to find the information you need, the following symbols and conventions are used:



This icon marks cautions; information that should be read before use to prevent damage to the camera.



This icon marks notes; information that should be read before using the camera.



This icon marks references to other pages in this manual.

Menu items, options, and messages displayed in the camera monitor are shown in **bold**.

### **Camera Settings**

The explanations in this manual assume that default settings are used.

### **Help**

Use the camera's on-board help feature for help on menu items and other topics. See page 18 for details.







































#### **⚠ For Your Safety**

Before using the camera for the first time, read the safety instructions in "For Your Safety" (📖 xviii–xix).

# Where to Find It

Find what you're looking for from:

 The Table of Contents .....  x	 The Index.....  338
 The Q&A Index.....  ii	 Error Messages.....  322
 Menu Options.....  iv	 Troubleshooting .....  316

 <b>Introduction</b>	 1
 <b>Basic Photography and Playback</b>	 35
 <b>Live View Photography</b>	 49
 <b>Movie Live View</b>	 57
 <b>P, S, A, and M Modes</b>	 73
 <b>User Settings: U1 and U2 Modes</b>	 81
 <b>Release Mode</b>	 83
 <b>Image Recording Options</b>	 89
 <b>Focus</b>	 97
 <b>ISO Sensitivity</b>	 105
 <b>Exposure</b>	 109
 <b>White Balance</b>	 115
 <b>Image Enhancement</b>	 129
 <b>Flash Photography</b>	 143
 <b>Other Shooting Options</b>	 151
 <b>More on Playback</b>	 177
 <b>Connections</b>	 193
 <b>Menu Guide</b>	 207
 <b>Technical Notes</b>	 285

# Q&A Index

Find what you're looking for using this "question and answer" index.



## Taking Photographs



### Shooting Modes and Framing Options

Is there a quick and easy way to take snapshots (AUTO mode)?	35–39
How do I quickly adjust settings for different scenes?	40–45
Can I adjust shutter speed to freeze or blur motion (mode S)?	76
Can I adjust aperture to blur backgrounds or bring them into focus (mode A)?	77
How do I make long ("time") exposures (mode M)?	79
Can I frame photos in the monitor (live view photography)?	49
Can I shoot movies (movie live view)?	57
Can I join photographs taken at regular intervals to create a time-lapse movie?	168



### Release Modes

Can I take photos one at a time or in quick succession?	6, 83
How do I take pictures with the self-timer or a remote control?	85
Can I reduce shutter noise in quiet surroundings (quiet shutter-release)?	6, 83



### Focus

Can I choose how the camera focuses?	97–100
Can I choose the focus point?	101



### Exposure

Can I make photos brighter or darker?	112
How do I preserve details in shadows and highlights?	137



### Using the Flash

Can I set the flash to fire automatically when needed?	
How do I keep the flash from firing?	35, 143–147
How do I avoid "red-eye"?	



### Image Quality and Size

How do I take pictures for printing at large sizes?	93–95
How can I get more pictures on the memory card?	



## Viewing Photographs



### Playback

How do I view photographs on the camera?	46, 177
How do I view more information about a photo?	179–184
Can I view photos in an automatic slide show?	213
Can I view photos on a TV?	204–205
Can I protect photos from accidental deletion?	188



### Deletion

How do I delete unwanted photos?	47, 189–191
----------------------------------	-------------





## **Retouching Photographs**



How do I create retouched copies of photos?	261–279
How do I remove “red-eye”?	264
How do I make JPEG copies of RAW (NEF) photos?	271
Can I overlay two NEF (RAW) photos to make a single image?	269–270
Can I create a copy of a photo that looks like a painting?	275
Can I trim movie footage on the camera or save movie stills?	69



## **Menus and Settings**



How do I use the menus?	18–20
How do I display menus in another language?	27, 253
How do I use the command dials?	12–16
How do I keep the displays from turning off?	228
How do I focus the viewfinder?	33
Can I display a framing grid in the viewfinder or the monitor?	55, 62, 229
How do I tell if the camera is level?	258
How do I set the camera clock?	27, 253
How do I format memory cards?	31, 250
How do I restore default settings?	151, 214, 221
How do I get help for a menu or message?	18, 322



## **Connections**



How do I copy photos to a computer?	193–195
How do I print photos?	196–203
Can I print the date of recording on my photos?	198, 203



## **Maintenance and Optional Accessories**



What memory cards can I use?	334
What lenses can I use?	285
What optional flash units (Speedlights) can I use?	292
What other accessories are available for my camera?	297–298
What software is available for my camera?	
What do I do with the supplied eyepiece cap?	86
How do I clean the camera?	
Where should I take my camera for servicing and repairs?	300

# Menu Options

## ▶ PLAYBACK MENU (📖 207)











<b>Delete</b>	Selected
	Select date
	All
<b>Playback folder</b>	ND610 (default)
	All
	Current
<b>Hide image</b>	Select/set
	Select date
	Deselect all?
<b>Playback display options</b> (SD)	Done
	Basic photo info
	Focus point
	Additional photo info
	None (image only)
	Highlights
	RGB histogram
	Shooting data
Overview	
<b>Copy image(s)</b>	Select source
	Select image(s)
	Select destination folder
	Copy image(s)?
<b>Image review</b> (SD)	On
	Off (default)
<b>After delete</b> (SD)	Show next (default)
	Show previous
	Continue as before
<b>Rotate tall</b> (SD)	On (default)
	Off
<b>Slide show</b>	Start
	Image type
	Frame interval
<b>DPOF print order</b>	Select/set
	Deselect all?



## 📷 SHOOTING MENU (📖 214)

<b>Reset shooting menu</b>	Yes
	No
<b>Storage folder</b>	Select folder by number
	Select folder from list
<b>File naming</b> (SD)	File naming
<b>Role played by card in Slot 2</b> (SD)	Overflow (default)
	Backup
	RAW Slot 1 - JPEG Slot 2
<b>Image quality</b> (SD)	NEF (RAW) + JPEG fine
	NEF (RAW) + JPEG normal
	NEF (RAW) + JPEG basic
	NEF (RAW)
	JPEG fine
	JPEG normal (default)
JPEG basic	
<b>Image size</b> (SD)	Large (default)
	Medium
	Small
<b>Image area</b> (SD)	Auto DX crop
	Choose image area
<b>JPEG compression</b> (SD)	Size priority (default)
<b>NEF (RAW) recording</b> (SD)	Type
<b>White balance</b> (SD)	NEF (RAW) bit depth
	Auto (default)
<b>White balance</b> (SD)	Incandescent
	Fluorescent
	Direct sunlight
	Flash
	Cloudy
	Shade
	Choose color temp.
Preset manual	



(SD)

Items marked with a (SD) icon can be saved to the memory card using the **Save/load settings > Save settings** option in the camera setup menu (📖 249). The saved settings can be copied to other D610 cameras by inserting the memory card into the camera and selecting **Save/load settings > Load settings**.

<b>Set Picture Control</b>	Standard (default)
	 Neutral
	Vivid
	Monochrome
	Portrait
<b>Manage Picture Control</b>	Landscape
	Save/edit
	Rename <sup>1</sup>
	Delete <sup>1</sup>
<b>Auto distortion control</b>	Load/save
	On
<b>Color space</b>	 Off (default)
	 sRGB (default)
<b>Active D-Lighting</b> <sup>2</sup>	Adobe RGB
	Auto
	 Extra high
	High
	Normal
<b>HDR (high dynamic range)</b>	Low
	Off
	HDR mode
<b>Vignette control</b>	Exposure differential
	Smoothing
	High
<b>Long exposure NR</b>	 Normal (default)
	Low
	Off
<b>High ISO NR</b>	 Off (default)
	High
	Normal (default)
<b>ISO sensitivity settings</b>	Low
	Off
<b>Remote control mode</b>	ISO sensitivity
	 Auto ISO sensitivity control
<b>Multiple exposure</b>	 + 
	 105
<b>Remote control mode</b>	Delayed remote (default)
	 Quick-response remote
<b>Multiple exposure</b>	Remote mirror-up
	Multiple exposure mode
	Number of shots
<b>Multiple exposure</b>	Auto gain

<b>Interval timer shooting</b>	Choose start time
	Now
	Start time
	Interval
<b>Time-lapse photography</b>	Select no. of times x no. of shots
	Start
<b>Movie settings</b> 	Start
	Interval
<b>Movie settings</b> 	Shooting time
	Frame size/frame rate
	Movie quality
	Microphone
<b>Movie settings</b> 	Destination

1 Not available if no custom Picture Controls are present.

2 Defaults to **Off** (modes **P, S, A, M, , , and **) or **Auto** (other modes).

## CUSTOM SETTING MENU ( 219)

<b>Reset custom settings</b>	Yes
	No
<b>a Autofocus</b> 	
a1 AF-C priority selection	Release (default)
	Focus
a2 AF-S priority selection	Release
	Focus (default)
a3 Focus tracking with lock-on	5 (Long)
	4
	3 (Normal) (default)
	2
	1 (Short)
a4 AF point illumination	Off
	Auto (default)
	On
a5 Focus point wrap-around	Off
	Wrap
a6 Number of focus points	No wrap (default)
	39 points (default)
a7 Built-in AF-assist illuminator	11 points
	On (default)
<b>Multiple exposure</b>	Off

<b>b Metering/exposure</b> <span style="float:right">SD</span>		
b1 ISO sensitivity step value	1/3 step	(default)
	1/2 step	
b2 EV steps for exposure cntrl	1/3 step	(default)
	1/2 step	
b3 Easy exposure compensation	On (Auto reset)	
	On	
	Off	(default)
b4 Center-weighted area	φ 8 mm	
	φ 12 mm	(default)
	φ 15 mm	
	φ 20 mm	
	Average	
b5 Fine-tune optimal exposure	Yes	
	No	(default)
<b>c Timers/AE lock</b> <span style="float:right">SD</span>		
c1 Shutter-release button AE-L	On	
	Off	(default)
c2 Standby timer	4 s	
	6 s	(default)
	10 s	
	30 s	
	1 min	
	5 min	
	10 min	
	30 min	
No limit		
c3 Self-timer	Self-timer delay	
	Number of shots	
	Interval between shots	
c4 Monitor off delay	Playback	
	Menus	
	Information display	
	Image review	
	Live view	
c5 Remote on duration	1 min	(default)
	5 min	
	10 min	
	15 min	



<b>d Shooting/display</b> <span style="float:right">SD</span>		
d1 Beep	Volume	
	Pitch	
d2 Viewfinder grid display	On	
	Off	(default)
d3 ISO display and adjustment	Show ISO sensitivity	
	Show ISO/Easy ISO	
	Show frame count	(default)
d4 Screen tips	On	(default)
	Off	
d5 CL mode shooting speed	5 fps	
	4 fps	
	3 fps	(default)
	2 fps	
	1 fps	
d6 Max. continuous release	1–100	
d7 File number sequence	On	(default)
	Off	
	Reset	
d8 Information display	Auto	(default)
	Manual	
d9 LCD illumination	On	
	Off	(default)
d10 Exposure delay mode	3 s	
	2 s	
	1 s	
	Off	(default)
d11 Flash warning	On	(default)
	Off	
d12 MB-D14 battery type	LR6 (AA alkaline)	(default)
	HR6 (AA Ni-MH)	
	FR6 (AA lithium)	
d13 Battery order	Use MB-D14 batteries first	(default)
	Use camera battery first	

<b>e Bracketing/flash</b>		<b>(SD)</b>
e1 Flash sync speed	1/250 s (Auto FP)	
	1/200 s (Auto FP)	
	1/200 s	(default)
	1/160 s	
	1/125 s	
	1/100 s	
	1/80 s	
e2 Flash shutter speed	1/60 s	(default)
	1/30 s	
	1/15 s	
	1/8 s	
	1/4 s	
	1/2 s	
	1 s	
	2 s	
	4 s	
	8 s	
	15 s	
30 s		
e3 Flash cntrl for built-in flash	TTL	(default)
	Manual	
	Repeating flash	
	Commander mode	
e3 Optional flash*	TTL	(default)
	Manual	
e4 Exposure comp. for flash	Entire frame	(default)
	Background only	
e5 Modeling flash	On	(default)
	Off	
e6 Auto bracketing set	AE & flash	(default)
	AE only	
	Flash only	
	WB bracketing	
	ADL bracketing	
e7 Bracketing order	MTR > under > over	(default)
	Under > MTR > over	

\* Displayed only when optional SB-400 or SB-300 flash unit is attached.

<b>f Controls</b>		<b>(SD)</b>
f1 OK button (shooting mode)	Select center focus point	(default)
	Highlight active focus point	
	Not used	

<b>f Controls</b>		<b>(SD)</b>
f2 Assign Fn button	Preview	
	FV lock	
	AE/AF lock	
	AE lock only	
	AE lock (Hold)	
	AF lock only	
	AF-ON	
	Flash off	
	Bracketing burst	
	Active D-Lighting	
	+ NEF (RAW)	
	Matrix metering	
	Center-weighted metering	
	Spot metering	
	Framing grid	
	Choose image area	(default)
	Viewfinder virtual horizon	
	MY MENU	
	Access top item in MY MENU	
1 step spd/aperture		
Choose non-CPU lens number		
Playback		
None		
f3 Assign preview button	Preview	(default)
	FV lock	
	AE/AF lock	
	AE lock only	
	AE lock (Hold)	
	AF lock only	
	AF-ON	
	Flash off	
	Bracketing burst	
	Active D-Lighting	
	+ NEF (RAW)	
	Matrix metering	
	Center-weighted metering	
	Spot metering	
	Framing grid	
	Choose image area	
	Viewfinder virtual horizon	
	MY MENU	
	Access top item in MY MENU	
1 step spd/aperture		
Choose non-CPU lens number		
Playback		
None		







<b>f Controls</b>		SD
f4 Assign AE-L/ AF-L button	AE/AF lock	(default)
	AE lock only	
	AE lock (Hold)	
	AF lock only	
	AF-ON	
	FV lock	
f5 Customize command dials	Reverse rotation	
	Change main/sub	
	Aperture setting	
	Menus and playback	
f6 Release button to use dial	Yes	
	No	(default)
f7 Slot empty release lock	Release locked	
	Enable release	(default)
f8 Reverse indicators		
		(default)
f9 Assign MB-D14  button	AE/AF lock	(default)
	AE lock only	
	AE lock (Hold)	
	AF lock only	
	AF-ON	
	FV lock	
Same as Fn button		

<b>g Movie</b>		SD
g1 Assign Fn button	Index marking	
	View photo shooting info	
	AE/AF lock	
	AE lock only	
	AE lock (Hold)	
	AF lock only	
	AF-ON	
	None	(default)
	g2 Assign preview button	Index marking
View photo shooting info		
AE/AF lock		
AE lock only		
AE lock (Hold)		
AF lock only		
AF-ON		
None		

<b>g Movie</b>		SD
g3 Assign AE-L/ AF-L button	Index marking	
	View photo shooting info	
	AE/AF lock	(default)
	AE lock only	
	AE lock (Hold)	
	AF lock only	
	AF-ON	
g4 Assign shutter button	Take photos	(default)
	Record movies	

## Y SETUP MENU ( 249)

<b>Format memory card</b>	Slot 1
	Slot 2
<b>Save user settings</b>	Save to U1
	Save to U2
<b>Reset user settings</b>	Reset U1
	Reset U2
<b>Monitor brightness</b>	Auto
	Manual (default)
<b>Clean image sensor</b>	Clean now
	Clean at startup/shutdown
<b>Lock mirror up for cleaning</b> <sup>1</sup>	Start
<b>Image Dust Off ref photo</b>	Start
	Clean sensor and then start
<b>HDMI</b>	Output resolution
	Device control
<b>Flicker reduction</b>	Auto (default)
	50 Hz
	60 Hz
<b>Time zone and date</b>	Time zone
	Date and time
	Date format
	Daylight saving time
<b>Language</b>	Čeština, Dansk, Deutsch, English, Español, Ελληνικά, Français, Indonesia, Italiano, Magyar, Nederlands, Norsk, Polski, Português (BR), Português (PT), Русский, Română, Suomi, Svenska, Türkçe, Українська, عربي, 中文 (繁體), 中文 (简体), 日本語, 한글, ไทย, हिन्दी



<b>Image comment</b>	Done
	 Input comment
	Attach comment
<b>Auto image rotation</b>	On (default)
	 Off
<b>Battery info</b>	–
<b>Copyright information</b>	Done
	 Artist
	Copyright Attach copyright information
<b>Save/load settings</b>	Save settings
	Load settings
<b>GPS</b>	 Standby timer
	Position
	Use GPS to set camera clock
<b>Virtual horizon</b>	–
<b>Non-CPU lens data</b>	Done
	 Lens number
	Focal length (mm)
	Maximum aperture
<b>AF fine-tune</b>	AF fine-tune (On/Off)
	Saved value
	Default
	List saved values
<b>Eye-Fi upload <sup>2</sup></b>	 Slot 1
	Slot 2
<b>Firmware version</b>	–

- 1 Not available at battery levels of  or below.
- 2 Available only with compatible Eye-Fi memory cards.



## RETOUCH MENU (📖 261)

<b>D-Lighting</b>	–
<b>Red-eye correction</b>	–
<b>Trim</b>	–
<b>Monochrome</b>	Black-and-white
	Sepia
	Cyanotype
<b>Filter effects</b>	Skylight
	Warm filter
	Red intensifier
	Green intensifier
	Blue intensifier
	Cross screen
	Soft

<b>Color balance</b>	–
<b>Image overlay <sup>1</sup></b>	–
<b>NEF (RAW) processing</b>	–
<b>Resize</b>	Select image
	Choose destination
	Choose size
<b>Quick retouch</b>	–
<b>Straighten</b>	–
<b>Distortion control</b>	Auto
	Manual
<b>Fisheye</b>	–
<b>Color outline</b>	–
<b>Color sketch</b>	–
<b>Perspective control</b>	–
<b>Miniature effect</b>	–
<b>Selective color</b>	–
<b>Edit movie</b>	Choose start/end point
	Save selected frame
<b>Side-by-side comparison <sup>2</sup></b>	–

- 1 Available only when **MENU** button is pressed and  tab selected in menus.
- 2 Only available when  or  button is pressed to display retouch menu during full-frame playback.

## MY MENU (📖 280)

<b>Add items</b>	 Playback menu
	Shooting menu
	Custom setting menu
	Setup menu
	Retouch menu
<b>Remove items *</b>	–
<b>Rank items</b>	–
<b>Choose tab</b>	 My Menu
	Recent settings

- \* Items can also be deleted by highlighting them in MY MENU and pressing the  (**REMOVE**) button twice.

# Table of Contents

Q&A Index .....	ii
Menu Options .....	iv
For Your Safety .....	xviii
Notices.....	xx
Package Contents.....	xxiv





## **Introduction** **1**

---

Getting to Know the Camera.....	1
The Camera Body .....	1
The Mode Dial.....	5
The Release-Mode Dial .....	6
The Control Panel .....	7
The Viewfinder.....	8
The Information Display.....	9
The Command Dials .....	12
The BM-14 Monitor Cover .....	17
Camera Menus.....	18
Using Camera Menus .....	19
First Steps .....	21
Charge the Battery .....	21
Insert the Battery .....	23
Attach a Lens.....	25
Basic Setup.....	27
Insert a Memory Card.....	29
Format the Memory Card .....	31
Adjust Viewfinder Focus .....	33

## **Basic Photography and Playback** **35**

---

“Point-and-Shoot” Photography (  and  Modes).....	35
Step 1: Turn the Camera On.....	35
Step 2: Select  or  Mode .....	36
Step 3: Frame the Photograph .....	37
Step 4: Focus .....	38
Step 5: Shoot .....	38



Creative Photography (Scene Modes) .....	40
Portrait.....	41
Landscape .....	41
Child.....	41
Sports.....	41
Close Up.....	42
Night Portrait .....	42
Night Landscape.....	42
Party/Indoor .....	42
Beach/Snow .....	43
Sunset.....	43
Dusk/Dawn .....	43
Pet Portrait.....	43
Candlelight.....	44
Blossom.....	44
Autumn Colors .....	44
Food .....	44
Silhouette.....	45
High Key.....	45
Low Key.....	45
Basic Playback.....	46
Deleting Unwanted Photographs.....	47

## **Live View Photography** **49**

---

Focusing in Live View .....	51
The Live View Display: Live View Photography .....	53
The Information Display: Live View Photography .....	55
Manual Focus .....	55

## **Movie Live View** **57**

---

Indices .....	60
The Live View Display: Movie Live View .....	61
The Information Display: Movie Live View.....	62
Image Area .....	63
Movie Settings .....	65
Viewing Movies .....	67
Editing Movies .....	69
Trimming Movies .....	69
Saving Selected Frames.....	72

## **P, S, A, and M Modes** **73**

---

P: Programmed Auto .....	75
S: Shutter-Priority Auto .....	76
A: Aperture-Priority Auto.....	77
M: Manual.....	78
Long Time-Exposures ( <b>M</b> Mode Only).....	79

## **User Settings: U1 and U2 Modes** **81**

---

Saving User Settings.....	81
Recalling User Settings .....	82
Resetting User Settings .....	82

## **Release Mode** **83**

---

Choosing a Release Mode .....	83
Self-Timer and Remote Control Modes .....	85
Mirror up Mode .....	88

## **Image Recording Options** **89**

---

Image Area .....	89
Image Quality and Size .....	93
Image Quality.....	93
Image Size .....	95
Using Two Memory Cards .....	96

## **Focus** **97**

---

Autofocus .....	97
Autofocus Mode .....	97
AF-Area Mode .....	99
Focus Point Selection.....	101
Focus Lock.....	102
Manual Focus .....	103

## **ISO Sensitivity** **105**

---

Auto ISO Sensitivity Control .....	107
------------------------------------	-----

<b>Exposure</b>	<b>109</b>
<hr/>	
Metering.....	109
Autoexposure Lock.....	110
Exposure Compensation.....	112
<b>White Balance</b>	<b>115</b>
<hr/>	
Fine-Tuning White Balance.....	117
Choosing a Color Temperature .....	120
Preset Manual .....	121
<b>Image Enhancement</b>	<b>129</b>
<hr/>	
Picture Controls.....	129
Selecting a Picture Control.....	129
Modifying Picture Controls .....	131
Creating Custom Picture Controls .....	134
Sharing Custom Picture Controls.....	136
Preserving Detail in Highlights and Shadows .....	137
Active D-Lighting.....	137
High Dynamic Range (HDR) .....	139
<b>Flash Photography</b>	<b>143</b>
<hr/>	
Using the Built-in Flash.....	143
Flash Mode.....	144
Flash Compensation.....	148
FV Lock.....	149
<b>Other Shooting Options</b>	<b>151</b>
<hr/>	
Two-Button Reset: Restoring Default Settings.....	151
Bracketing .....	153
Multiple Exposure.....	160
Interval Timer Photography.....	164
Time-Lapse Photography .....	168
Non-CPU Lenses.....	172
The GP-1/GP-1A GPS Unit.....	175

## More on Playback 177

---

Full-Frame Playback.....	177
Photo Information.....	179
Thumbnail Playback .....	185
Calendar Playback .....	186
Taking a Closer Look: Playback Zoom.....	187
Protecting Photographs from Deletion.....	188
Deleting Photographs .....	189
Full-Frame, Thumbnail, and Calendar Playback.....	189
The Playback Menu .....	190

## Connections 193

---



Connecting to a Computer .....	193
Before Connecting the Camera .....	193
Connecting the Camera .....	194
Printing Photographs.....	196
Connecting the Printer .....	196
Printing Pictures One at a Time .....	197
Printing Multiple Pictures .....	199
Creating a DPOF Print Order: Print Set .....	202
Viewing Photographs on TV .....	204



## Menu Guide 207

---

▶ The Playback Menu: <i>Managing Images</i> .....	207
Playback Folder.....	207
Hide Image .....	208
Playback Display Options.....	209
Copy Image(s) .....	209
Image Review .....	212
After Delete .....	212
Rotate Tall .....	212
Slide Show .....	213
📷 The Shooting Menu: <i>Shooting Options</i> .....	214
Reset Shooting Menu .....	214
Storage Folder.....	215
File Naming .....	216
Auto Distortion Control .....	217
Color Space .....	217
Vignette Control.....	218
Long Exposure NR (Long Exposure Noise Reduction).....	218
High ISO NR.....	218

 Custom Settings: <i>Fine-Tuning Camera Settings</i> .....	219
Reset Custom Settings.....	221
a: Autofocus .....	221
a1: AF-C Priority Selection .....	221
a2: AF-S Priority Selection .....	221
a3: Focus Tracking with Lock-On .....	222
a4: AF Point Illumination .....	222
a5: Focus Point Wrap-Around .....	222
a6: Number of Focus Points .....	223
a7: Built-in AF-assist Illuminator .....	223
b: Metering/Exposure .....	224
b1: ISO Sensitivity Step Value .....	224
b2: EV Steps for Exposure Cntrl .....	224
b3: Easy Exposure Compensation .....	225
b4: Center-Weighted Area .....	226
b5: Fine-tune Optimal Exposure .....	226
c: Timers/AE Lock .....	226
c1: Shutter-Release Button AE-L .....	226
c2: Standby timer .....	227
c3: Self-Timer.....	227
c4: Monitor off Delay .....	228
c5: Remote on Duration .....	228
d: Shooting/Display.....	228
d1: Beep .....	228
d2: Viewfinder Grid Display .....	229
d3: ISO Display and Adjustment .....	229
d4: Screen Tips.....	229
d5: CL Mode Shooting Speed .....	229
d6: Max. Continuous Release .....	230
d7: File Number Sequence.....	230
d8: Information Display.....	231
d9: LCD Illumination.....	231
d10: Exposure Delay Mode .....	231
d11: Flash Warning .....	231
d12: MB-D14 Battery Type .....	232
d13: Battery Order .....	233
e: Bracketing/Flash .....	234
e1: Flash Sync Speed .....	234
e2: Flash Shutter Speed.....	235
e3: Flash Cntrl for Built-in Flash .....	236
e4: Exposure Comp. for Flash.....	240
e5: Modeling Flash.....	241
e6: Auto Bracketing Set.....	241
e7: Bracketing Order.....	241

f: Controls .....	241
f1: OK Button (Shooting Mode).....	241
f2: Assign Fn Button .....	242
f3: Assign Preview Button .....	244
f4: Assign AE-L/AF-L Button .....	244
f5: Customize Command Dials .....	245
f6: Release Button to Use Dial.....	246
f7: Slot Empty Release Lock.....	246
f8: Reverse Indicators.....	246
f9: Assign MB-D14  Button .....	247
g: Movie.....	247
g1: Assign Fn Button .....	247
g2: Assign Preview Button .....	248
g3: Assign AE-L/AF-L Button .....	248
g4: Assign Shutter Button .....	248
 The Setup Menu: <i>Camera Setup</i> .....	249
Format Memory Card .....	250
Monitor Brightness.....	250
Image Dust Off Ref Photo .....	251
Flicker Reduction.....	252
Time Zone and Date .....	253
Language .....	253
Image Comment .....	253
Auto Image Rotation .....	254
Battery Info.....	255
Copyright Information .....	256
Save/Load Settings.....	257
Virtual Horizon .....	258
AF Fine-tune .....	259
Eye-Fi Upload .....	260
Firmware Version .....	260
 The Retouch Menu: <i>Creating Retouched Copies</i> .....	261
Creating Retouched Copies .....	262
D-Lighting.....	264
Red-Eye Correction.....	264
Trim .....	265
Monochrome .....	266
Filter Effects.....	267
Color Balance.....	268
Image Overlay .....	269
NEF (RAW) Processing .....	271
Resize.....	272
Quick Retouch.....	273
Straighten .....	274
Distortion Control.....	274
Fisheye .....	274
Color Outline .....	275

Color Sketch .....	275
Perspective Control .....	275
Miniature Effect .....	276
Selective Color .....	277
Side-by-side Comparison .....	279
 My Menu/  Recent Settings .....	280
Recent Settings .....	283

## Technical Notes

**285**

---

Compatible Lenses .....	285
Optional Flash Units (Speedlights) .....	292
The Nikon Creative Lighting System (CLS) .....	293
Other Accessories .....	297
Attaching a Power Connector and AC Adapter .....	299
Caring for the Camera .....	300
Storage .....	300
Cleaning .....	300
The Low-Pass Filter .....	301
“Clean Now” .....	301
“Clean at Startup/Shutdown” .....	302
Manual Cleaning .....	303
Caring for the Camera and Battery: Cautions .....	306
Available Settings .....	309
Defaults .....	312
Exposure Program (Mode <b>P</b> ) .....	315
Troubleshooting .....	316
Battery/Display .....	316
Shooting (All Modes) .....	317
Shooting ( <b>P, S, A, M</b> ) .....	319
Playback .....	320
Miscellaneous .....	321
Error Messages .....	322
Specifications .....	326
Approved Memory Cards .....	334
Memory Card Capacity .....	335
Battery Life .....	337
Index .....	338

# For Your Safety

To prevent damage to your Nikon product or injury to yourself or to others, read the following safety precautions in their entirety before using this equipment. Keep these safety instructions where all those who use the product will read them.

The consequences that could result from failure to observe the precautions listed in this section are indicated by the following symbol:



This icon marks warnings. To prevent possible injury, read all warnings before using this Nikon product.

## ■ ■ WARNINGS

### **Keep the sun out of the frame**

Keep the sun well out of the frame when shooting backlit subjects. Sunlight focused into the camera when the sun is in or close to the frame could cause a fire.

### **Do not look at the sun through the viewfinder**

Viewing the sun or other strong light source through the viewfinder could cause permanent visual impairment.

### **Using the viewfinder diopter adjustment control**

When operating the viewfinder diopter adjustment control with your eye to the viewfinder, care should be taken not to put your finger in your eye accidentally.

### **Turn off immediately in the event of malfunction**

Should you notice smoke or an unusual smell coming from the equipment or AC adapter (available separately), unplug the AC adapter and remove the battery immediately, taking care to avoid burns. Continued operation could result in injury. After removing the battery, take the equipment to a Nikon-authorized service center for inspection.

### **Do not use in the presence of flammable gas**

Do not use electronic equipment in the presence of flammable gas, as this could result in explosion or fire.

### **Do not place the strap around the neck of an infant or child**

Placing the camera strap around the neck of an infant or child could result in strangulation.

### **Keep out of reach of children**

Failure to observe this precaution could result in injury. In addition, note that small parts constitute a choking hazard. Should a child swallow any part of this equipment, consult a physician immediately.

### **Do not disassemble**

Touching the product's internal parts could result in injury. In the event of malfunction, the product should be repaired only by a qualified technician. Should the product break open as the result of a fall or other accident, remove the battery and/or AC adapter and then take the product to a Nikon-authorized service center for inspection.

### **Do not remain in contact with the camera, battery, or charger for extended periods while the devices are on or in use**

Parts of the device become hot. Leaving the device in direct contact with the skin for extended periods may result in low-temperature burns.

### **Do not leave the product where it will be exposed to extremely high temperatures, such as in an enclosed automobile or in direct sunlight**

Failure to observe this precaution could cause damage or fire.

### **Do not aim a flash at the operator of a motor vehicle**

Failure to observe this precaution could result in accidents.

### **Avoid contact with liquid crystal**

Should the monitor break, care should be taken to avoid injury due to broken glass and to prevent the liquid crystal from the monitor touching the skin or entering the eyes or mouth.



**⚠ Observe caution when using the flash**

- Using the camera with the flash in close contact with the skin or other objects could cause burns.
- Using the flash close to the subject's eyes could cause temporary visual impairment. The flash should be no less than one meter (3 ft 4 in.) from the subject. Particular care should be observed when photographing infants.

**⚠ Observe proper precautions when handling batteries**

Batteries may leak or explode if improperly handled. Observe the following precautions when handling batteries for use in this product:

- Use only batteries approved for use in this equipment.
- Do not short or disassemble the battery.
- Be sure the product is off before replacing the battery. If you are using an AC adapter, be sure it is unplugged.
- Do not attempt to insert the battery upside down or backwards.
- Do not expose the battery to flame or to excessive heat.
- Do not immerse in or expose to water.
- Replace the terminal cover when transporting the battery. Do not transport or store the battery with metal objects such as necklaces or hairpins.
- Batteries are prone to leakage when fully discharged. To avoid damage to the product, be sure to remove the battery when no charge remains.
- When the battery is not in use, attach the terminal cover and store in a cool, dry place.
- The battery may be hot immediately after use or when the product has been used on battery power for an extended period. Before removing the battery turn the camera off and allow the battery to cool.
- Discontinue use immediately should you notice any changes in the battery, such as discoloration or deformation.

**⚠ Observe proper precautions when handling the charger**

- Keep dry. Failure to observe this precaution could result in injury or product malfunction due to fire or electric shock.
- Dust on or near the metal parts of the plug should be removed with a dry cloth. Continued use could result in fire.

- Do not handle the power cable or go near the charger during thunderstorms. Failure to observe this precaution could result in electric shock.
- Do not damage, modify, or forcibly tug or bend the power cable. Do not place it under heavy objects or expose it to heat or flame. Should the insulation be damaged and the wires become exposed, take the power cable to a Nikon-authorized service representative for inspection. Failure to observe this precaution could result in fire or electric shock.
- Do not handle the plug or charger with wet hands. Failure to observe this precaution could result in injury or product malfunction due to fire or electric shock.
- Do not use with travel converters or adapters designed to convert from one voltage to another or with DC-to-AC inverters. Failure to observe this precaution could damage the product or cause overheating or fire.

**⚠ Use appropriate cables**

When connecting cables to the input and output jacks, use only the cables provided or sold by Nikon for the purpose to maintain compliance with product regulations.

**⚠ CD-ROMs**

CD-ROMs containing software or manuals should not be played back on audio CD equipment. Playing CD-ROMs on an audio CD player could cause hearing loss or damage the equipment.

**⚠ Do not carry tripods with a lens or camera attached**

You could trip or accidentally strike others, resulting in injury.

**⚠ Follow the instructions of airline and hospital personnel**

This camera transmits radio frequencies that could interfere with medical equipment or aircraft navigation. Disable the wireless network feature and remove all wireless accessories from the camera before boarding an aircraft, and turn the camera off during take off and landing. In medical facilities, follow staff instructions regarding the use of wireless devices.

# Notices

- No part of the manuals included with this product may be reproduced, transmitted, transcribed, stored in a retrieval system, or translated into any language in any form, by any means, without Nikon's prior written permission.
- Nikon reserves the right to change the specifications of the hardware and software described in these manuals at any time and without prior notice.
- Nikon will not be held liable for any damages resulting from the use of this product.
- While every effort has been made to ensure that the information in these manuals is accurate and complete, we would appreciate it were you to bring any errors or omissions to the attention of the Nikon representative in your area (address provided separately).

## **Notices for Customers in Canada**

CAN ICES-3 B / NMB-3 B

## **Notices for Customers in Europe**

### **CAUTION**

RISK OF EXPLOSION IF BATTERY IS REPLACED BY AN INCORRECT TYPE. DISPOSE OF USED BATTERIES ACCORDING TO THE INSTRUCTIONS.

This symbol indicates that electrical and electronic equipment is to be collected separately.



The following apply only to users in European countries:

- This product is designated for separate collection at an appropriate collection point. Do not dispose of as household waste.
- Separate collection and recycling helps conserve natural resources and prevent negative consequences for human health and the environment that might result from incorrect disposal.
- For more information, contact the retailer or the local authorities in charge of waste management.

This symbol on the battery indicates that the battery is to be collected separately.



The following apply only to users in European countries:

- All batteries, whether marked with this symbol or not, are designated for separate collection at an appropriate collection point. Do not dispose of as household waste.
- For more information, contact the retailer or the local authorities in charge of waste management.

## **Notices for Customers in the U.S.A.**

### **Power Cable**

**At voltages over AC 125 V (U.S.A. only):** The power cable must be rated for the voltage in use, be at least AWG no. 18 gauge, and have SVG insulation or better with a NEMA 6P-15 plug rated for AC 250 V 15 A.

### **Federal Communications Commission (FCC) Radio Frequency Interference Statement**

This equipment has been tested and found to comply with the limits for a Class B digital device, pursuant to Part 15 of the FCC rules. These limits are designed to provide reasonable protection against harmful interference in a residential installation. This equipment generates, uses, and can radiate radio frequency energy and, if not installed and used in accordance with the instructions, may cause harmful interference to radio communications. However, there is no guarantee that interference will not occur in a particular installation. If this equipment does cause harmful interference to radio or television reception, which can be determined by turning the equipment off and on, the user is encouraged to try to correct the interference by one or more of the following measures:

- Reorient or relocate the receiving antenna.
- Increase the separation between the equipment and receiver.
- Connect the equipment into an outlet on a circuit different from that to which the receiver is connected.
- Consult the dealer or an experienced radio/television technician for help.



### **CAUTIONS**

#### ***Modifications***

The FCC requires the user be notified that any changes or modifications made to this device that are not expressly approved by Nikon Corporation may void the user's authority to operate the equipment.

#### ***Interface Cables***

Use the interface cables sold or provided by Nikon for your equipment. Using other interface cables may exceed the limits of Class B Part 15 of the FCC rules.

#### **Notice for Customers in the State of California**

**WARNING:** Handling the cord on this product may expose you to lead, a chemical known to the State of California to cause birth defects or other reproductive harm. *Wash hands after handling.*

Nikon Inc., 1300 Walt Whitman Road,  
Melville, New York 11747-3064, U.S.A.  
Tel.: 631-547-4200

### **Notice Concerning Prohibition of Copying or Reproduction**

Note that simply being in possession of material that has been digitally copied or reproduced by means of a scanner, digital camera, or other device may be punishable by law.

- **Items prohibited by law from being copied or reproduced**

Do not copy or reproduce paper money, coins, securities, government bonds, or local government bonds, even if such copies or reproductions are stamped "Sample."

The copying or reproduction of paper money, coins, or securities which are circulated in a foreign country is prohibited.

Unless the prior permission of the government has been obtained, the copying or reproduction of unused postage stamps or post cards issued by the government is prohibited.

The copying or reproduction of stamps issued by the government and of certified documents stipulated by law is prohibited.

- **Cautions on certain copies and reproductions**

The government has issued cautions on copies or reproductions of securities issued by private companies (shares, bills, checks, gift certificates, etc.), commuter passes, or coupon tickets, except when a minimum of necessary copies are to be provided for business use by a company. Also, do not copy or reproduce passports issued by the government, licenses issued by public agencies and private groups, ID cards, and tickets, such as passes and meal coupons.

- **Comply with copyright notices**

The copying or reproduction of copyrighted creative works such as books, music, paintings, woodcuts, prints, maps, drawings, movies, and photographs is governed by national and international copyright laws. Do not use this product for the purpose of making illegal copies or to infringe copyright laws.

### **Disposing of Data Storage Devices**

Please note that deleting images or formatting memory cards or other data storage devices does not completely erase the original image data. Deleted files can sometimes be recovered from discarded storage devices using commercially available software, potentially resulting in the malicious use of personal image data. Ensuring the privacy of such data is the user's responsibility.

Before discarding a data storage device or transferring ownership to another person, erase all data using commercial deletion software, or format the device and then completely refill it with images containing no private information (for example, pictures of empty sky). Be sure to also replace any pictures selected for preset manual (☐ 121). Care should be taken to avoid injury when physically destroying data storage devices.

### **AVC Patent Portfolio License**

THIS PRODUCT IS LICENSED UNDER THE AVC PATENT PORTFOLIO LICENSE FOR THE PERSONAL AND NON-COMMERCIAL USE OF A CONSUMER TO (i) ENCODE VIDEO IN COMPLIANCE WITH THE AVC STANDARD ("AVC VIDEO") AND/OR (ii) DECODE AVC VIDEO THAT WAS ENCODED BY A CONSUMER ENGAGED IN A PERSONAL AND NON-COMMERCIAL ACTIVITY AND/OR WAS OBTAINED FROM A VIDEO PROVIDER LICENSED TO PROVIDE AVC VIDEO. NO LICENSE IS GRANTED OR SHALL BE IMPLIED FOR ANY OTHER USE. ADDITIONAL INFORMATION MAY BE OBTAINED FROM MPEG LA, L.L.C. SEE <http://www.mpegla.com>

### **Use Only Nikon Brand Electronic Accessories**

Nikon cameras are designed to the highest standards and include complex electronic circuitry. Only Nikon brand electronic accessories (including chargers, batteries, AC adapters, and flash accessories) certified by Nikon specifically for use with this Nikon digital camera are engineered and proven to operate within the operational and safety requirements of this electronic circuitry.

The use of non-Nikon electronic accessories could damage the camera and may void your Nikon warranty. The use of third-party rechargeable Li-ion batteries not bearing the Nikon holographic seal shown at right could interfere with normal operation of the camera or result in the batteries overheating, igniting, rupturing, or leaking.

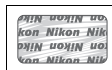

For more information about Nikon brand accessories, contact a local authorized Nikon dealer.

#### **✔ Use Only Nikon Brand Accessories**

Only Nikon brand accessories certified by Nikon specifically for use with your Nikon digital camera are engineered and proven to operate within its operational and safety requirements. THE USE OF NON-NIKON ACCESSORIES COULD DAMAGE YOUR CAMERA AND MAY VOID YOUR NIKON WARRANTY.

#### **✔ Servicing the Camera and Accessories**

The camera is a precision device and requires regular servicing. Nikon recommends that the camera be inspected by the original retailer or a Nikon-authorized service representative once every one to two years, and that it be serviced once every three to five years (note that fees apply to these services). Frequent inspection and servicing are particularly recommended if the camera is used professionally. Any accessories regularly used with the camera, such as lenses or optional flash units, should be included when the camera is inspected or serviced.

#### **✍ Before Taking Important Pictures**

Before taking pictures on important occasions (such as at weddings or before taking the camera on a trip), take a test shot to ensure that the camera is functioning normally. Nikon will not be held liable for damages or lost profits that may result from product malfunction.

#### **✍ Life-Long Learning**

As part of Nikon's "Life-Long Learning" commitment to ongoing product support and education, continually-updated information is available on-line at the following sites:

- **For users in the U.S.A.:** <http://www.nikonusa.com/>
- **For users in Europe and Africa:** <http://www.europe-nikon.com/support/>
- **For users in Asia, Oceania, and the Middle East:** <http://www.nikon-asia.com/>

Visit these sites to keep up-to-date with the latest product information, tips, answers to frequently-asked questions (FAQs), and general advice on digital imaging and photography. Additional information may be available from the Nikon representative in your area. See the following URL for contact information: <http://imaging.nikon.com/>

# Package Contents

Be sure all items listed here were included with your camera.

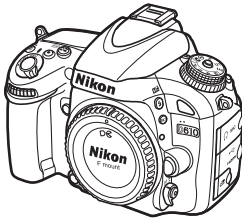

- D610 camera



- BS-1 accessory shoe cover



- DK-21 rubber eyecup



- BM-14 monitor cover



- BF-1B body cap

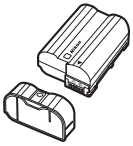

- EN-EL15 rechargeable Li-ion battery (with terminal cover)

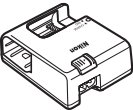

- MH-25 battery charger (AC wall adapter supplied only in countries or regions where required. Shape of power cable depends on country of sale.)

- AN-DC10 strap
- UC-E15 USB cable
- ViewNX 2 CD
- *User's Manual* (this guide)
- Warranty

*Memory cards are sold separately.*



- DK-5 eyepiece cap

## The Camera Strap

Attach the strap securely to the two eyelets on the camera body as shown below.

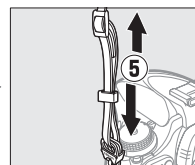
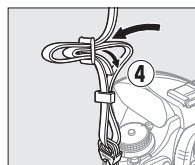
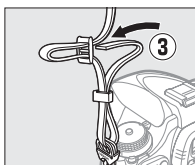
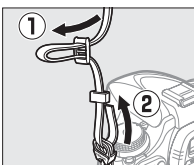



# Introduction

## Getting to Know the Camera

Take a few moments to familiarize yourself with camera controls and displays. You may find it helpful to bookmark this section and refer to it as you read through the rest of the manual.

### The Camera Body

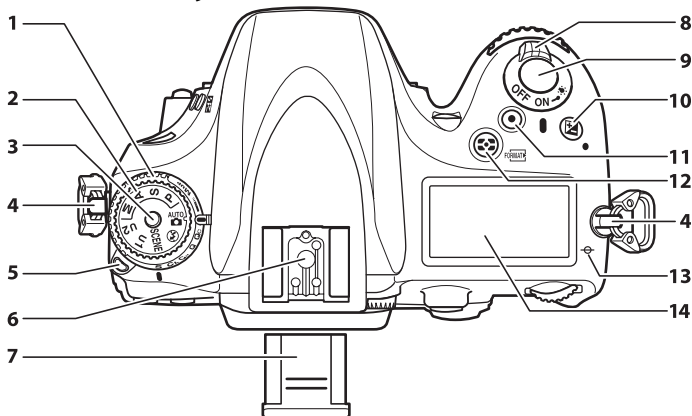

<b>1</b> Release mode dial .....6, 83	<b>10</b> button
<b>2</b> Mode dial .....5	Exposure compensation ..... 112
<b>3</b> Mode dial lock release .....5	Two-button reset ..... 151
<b>4</b> Eyelet for camera strap	<b>11</b> Movie-record button .....58
<b>5</b> Release mode dial lock release .....6, 83	<b>12</b> button
<b>6</b> Accessory shoe (for optional flash unit) .....292	Metering ..... 109
<b>7</b> Accessory shoe cover .....292	Formatting memory cards .....31
<b>8</b> Power switch .....1	<b>13</b> Focal plane mark (⊖) ..... 103
<b>9</b> Shutter-release button .....38, 39	<b>14</b> Control panel .....7

#### The Power Switch

Rotate the power switch as shown to turn the camera on.

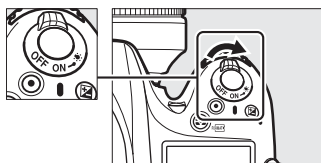

Rotate the power switch as shown to turn the camera off.

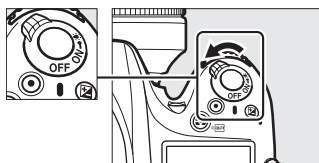

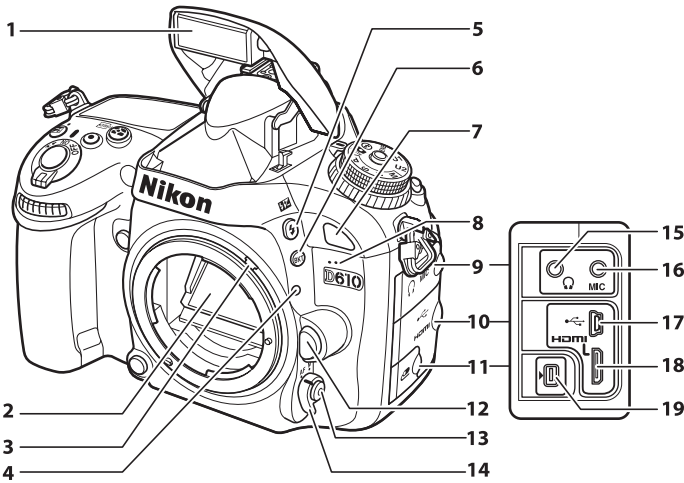

<b>1</b> Built-in flash ..... 143	<b>10</b> HDMI/USB connector cover ..... 194, 196, 204
<b>2</b> Mirror ..... 88, 303	<b>11</b> Cover for accessory terminal ..... 298
<b>3</b> Meter coupling lever ..... 328	<b>12</b> Lens release button ..... 26
<b>4</b> Lens mounting mark ..... 26	<b>13</b> AF-mode button ..... 51, 98, 100
<b>5</b> button	<b>14</b> Focus-mode selector ..... 97, 103
Flash mode ..... 143	<b>15</b> Headphone connector ..... 61
Flash compensation ..... 148	<b>16</b> Connector for external microphone ..... 61
<b>6</b> <b>BKT</b> button	<b>17</b> USB connector
Bracketing ..... 153, 156, 158	Connecting to a computer ..... 194
<b>7</b> Infrared receiver (front) ..... 86	Connecting to a printer ..... 196
<b>8</b> Built-in microphone ..... 58, 65	<b>18</b> HDMI mini-pin connector ..... 204
<b>9</b> Audio connector cover ..... 61, 298	<b>19</b> Accessory terminal ..... 175, 298

**LCD Illuminators**

Rotating the power switch toward activates the standby timer and control panel backlight (LCD illuminator), allowing the display to be read in the dark. After the power switch is released and returns to the **ON** position, the illuminators will remain lit for six seconds while the standby timer is active or until the shutter is released or the power switch is rotated toward again.

*Power switch*

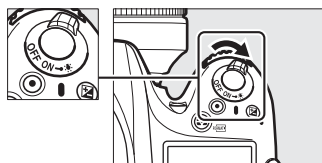



## The Camera Body (Continued)

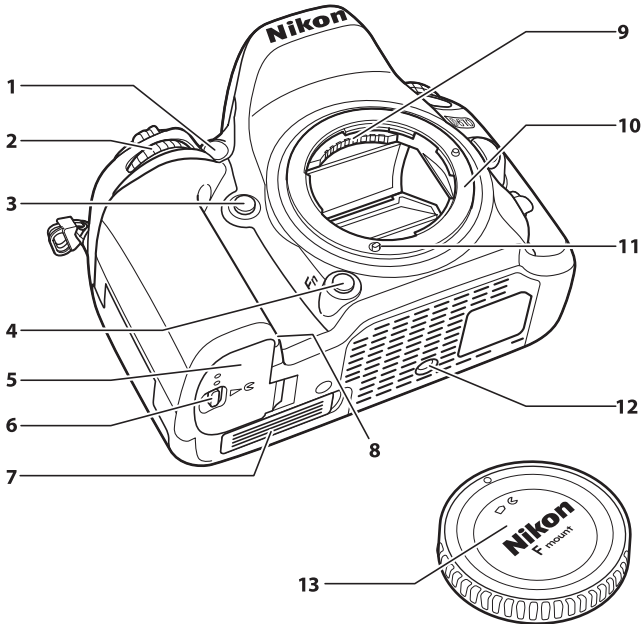

<b>1</b> AF-assist illuminator .....	223	<b>7</b> Contact cover for optional MB-D14 battery pack .....	297
Self-timer lamp .....	86	<b>8</b> Power connector cover .....	299
Red-eye reduction lamp .....	145	<b>9</b> CPU contacts .....	
<b>2</b> Sub-command dial.....	12, 245	<b>10</b> Lens mount.....	26, 103
<b>3</b> Depth-of-field preview button...	60, 77, 244, 248	<b>11</b> AF coupling .....	
<b>4</b> Fn (function) button .....	92, 149, 174, 242	<b>12</b> Tripod socket .....	
<b>5</b> Battery-chamber cover .....	23	<b>13</b> Body cap.....	25, 298
<b>6</b> Battery-chamber cover latch .....	23		

### The Microphone and Speaker

Do not place the microphone or speaker in close proximity to magnetic devices. Failure to observe this precaution could affect the data recorded on the magnetic devices.

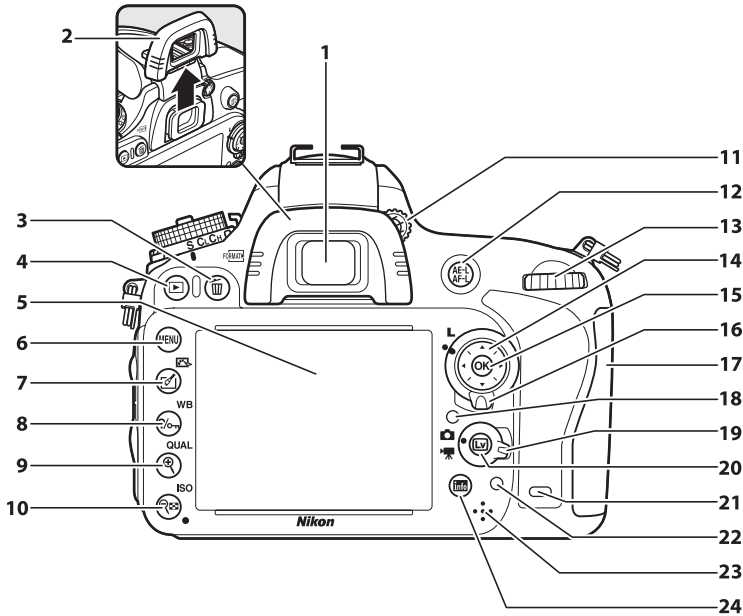

<b>1</b>	Viewfinder eyepiece.....	33	<b>10</b>	Q/ISO button	
<b>2</b>	Rubber eyecup .....	86		Playback zoom out/thumbnails.....	185, 186
<b>3</b>	DELETE/FORMAT button			ISO sensitivity .....	105
	Delete .....	47, 189		Auto ISO sensitivity control.....	107
	Formatting memory cards.....	31		Two-button reset.....	151
<b>4</b>	PLAYBACK button		<b>11</b>	Diopter adjustment control .....	33
	Playback .....	46, 177	<b>12</b>	AE/AF lock button	
<b>5</b>	Monitor			Using the AE/AF lock button .....	102, 110, 244
	Viewing settings.....	9	<b>13</b>	Main command dial .....	12, 245
	Live view .....	49, 57	<b>14</b>	Multi selector.....	19
	Viewing pictures .....	46	<b>15</b>	OK (OK) button .....	19, 241
	Full-frame playback.....	177	<b>16</b>	Focus selector lock .....	101
<b>6</b>	MENU button		<b>17</b>	Memory card slot cover .....	29
	Menu.....	18, 207	<b>18</b>	Ambient brightness sensor for automatic monitor brightness control.....	53, 250
<b>7</b>	RET/OK button		<b>19</b>	Live view selector	
	Retouch .....	69, 261		Live view photography .....	49
	Picture Control.....	50, 129		Movie live view .....	57
<b>8</b>	HELP/WB button		<b>20</b>	LV button.....	49, 57
	Help.....	18	<b>21</b>	Infrared receiver.....	86
	Protect .....	188	<b>22</b>	Memory card access lamp .....	29, 38
	White balance.....	115, 117, 120	<b>23</b>	Speaker .....	67
<b>9</b>	Q/QUAL button		<b>24</b>	Info (info) button.....	9, 11
	Playback zoom in.....	187			
	Image quality/size .....	93, 95			

# The Mode Dial

The camera offers the modes listed below. To choose a mode, press the mode dial lock release and rotate the mode dial.

Mode dial

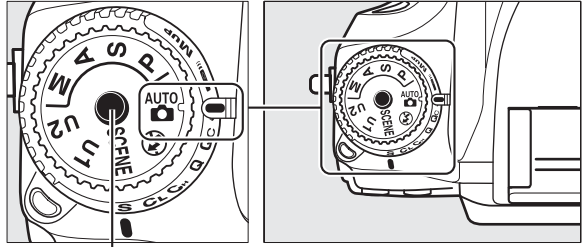

Mode dial lock release

## P, S, A, and M Modes

Select these modes for full control over camera settings.

- **P—Programmed auto** (☐ 75)
- **S—Shutter-priority auto** (☐ 76)
- **A—Aperture-priority auto** (☐ 77)
- **M—Manual** (☐ 78)

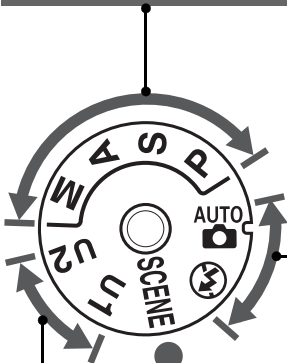

## Auto Modes

Select these modes for simple, point-and-shoot photography.

- **Auto** (☐ 35)
- **Auto (flash off)** (☐ 35)

## Scene Modes (☐ 40)

The camera automatically optimizes settings to suit the selected scene. Match your selection to the scene being photographed.

## U1 and U2 Modes (☐ 81)

Store and recall customized shooting settings.

## Non-CPU Lenses

Non-CPU (☐ 285) lenses can be used only in modes **A** and **M**. Selecting another mode when a non-CPU lens is attached disables the shutter release.



# The Release-Mode Dial

To choose a release mode, press the release mode dial lock release and turn the release mode dial to the desired setting (☞ 83).

Release mode dial lock release

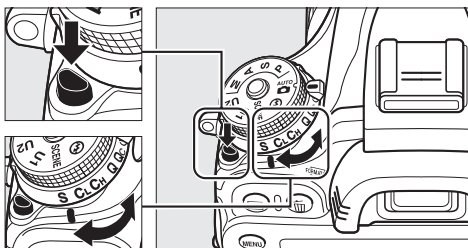

Release mode dial

Mode	Description
<b>S</b> <b>Single frame</b>	One photograph is taken each time the shutter-release button is pressed.
<b>CL</b> <b>Continuous low speed</b>	The camera takes photographs at a slow rate while the shutter-release button is pressed.
<b>CH</b> <b>Continuous high speed</b>	The camera takes photographs at a fast rate while the shutter-release button is pressed.
<b>Q</b> <b>Quiet shutter-release</b>	As for single-frame, except that camera noise is reduced.
<b>Qc</b> <b>Qc (quiet continuous) shutter-release</b>	The camera takes photographs while the shutter-release button is pressed; camera noise is reduced.
<b>Self-timer</b>	Take pictures with the self-timer.
<b>Remote control</b>	Take pictures with an optional ML-L3 remote control.
<b>MUP</b> <b>Mirror up</b>	Raise the mirror before taking photographs.

# The Control Panel

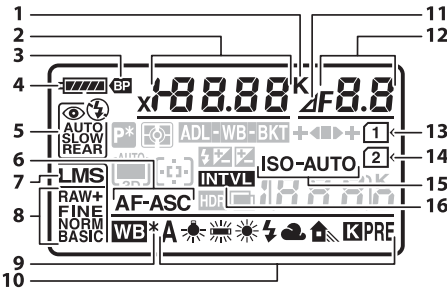

1	Color temperature indicator .....	120
2	Shutter speed .....	76, 78
	Exposure compensation value .....	112
	Flash compensation value .....	148
	White balance fine-tuning .....	118
	Color temperature .....	115, 120
	White balance preset number .....	121
	Number of shots in exposure and flash bracketing sequence .....	153
	Number of shots in WB bracketing sequence .....	156
	Number of intervals for interval timer photography .....	165
	Focal length (non-CPU lenses) .....	172

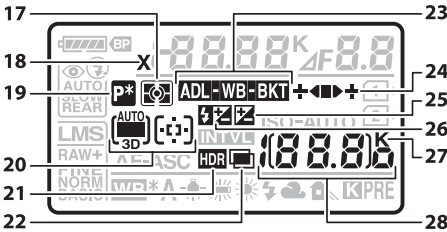

17	Metering .....	109
18	Flash sync indicator .....	234
19	Flexible program indicator .....	75
20	Auto-area AF indicator .....	99
	AF-area mode indicator .....	100
	3D-tracking indicator .....	99
21	HDR indicator .....	140
22	Multiple exposure indicator .....	161

3	MB-D14 battery indicator .....	233
4	Battery indicator .....	35
5	Flash mode .....	144
6	Autofocus mode .....	97
7	Image size .....	95
8	Image quality .....	93
9	White balance fine-tuning indicator .....	118
10	White balance .....	115
11	Aperture stop indicator .....	73, 288
12	Aperture (f-number) .....	77, 78
	Aperture (number of stops) .....	73, 288
	Bracketing increment .....	154, 156
	Number of shots in ADL bracketing sequence .....	158
	Number of shots per interval .....	165
	Maximum aperture (non-CPU lenses) .....	174
	PC mode indicator .....	195
13	Memory card indicator (Slot 1) .....	30, 96
14	Memory card indicator (Slot 2) .....	30, 96
15	ISO sensitivity indicator .....	105
	Auto ISO sensitivity indicator .....	108
16	Interval timer indicator .....	166
	Time-lapse indicator .....	170

23	Exposure and flash bracketing indicator .....	153
	WB bracketing indicator .....	156
	ADL bracketing indicator .....	158
24	Bracketing progress indicator .....	153, 156, 158
25	Exposure compensation indicator .....	112
26	Flash compensation indicator .....	148
27	"K" (appears when memory remains for over 1000 exposures) .....	36
28	Number of exposures remaining .....	36
	Number of shots remaining before memory buffer fills .....	38, 84, 335
	ISO sensitivity .....	105
	Preset white balance recording indicator .....	122
	Active D-Lighting amount .....	138
	Time-lapse recording indicator .....	170
	Manual lens number .....	174
	Capture mode indicator .....	195
	HDMI-CEC connection indicator .....	205



# The Viewfinder

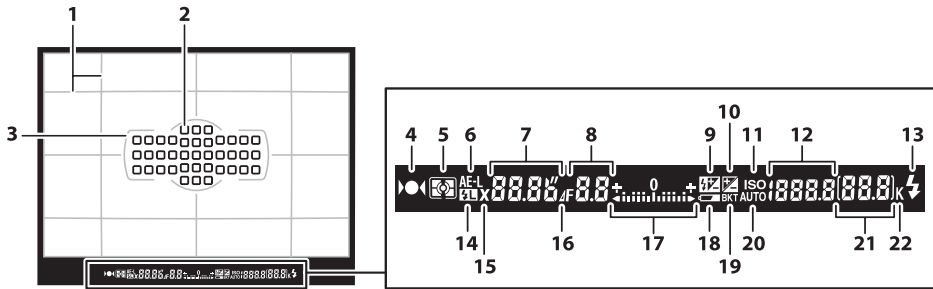

<b>1</b> Framing grid (displayed when <b>On</b> is selected for Custom Setting d2) .....	229	<b>14</b> FV lock indicator .....	149
<b>2</b> Focus points ..... 38, 101, 222		<b>15</b> Flash sync indicator.....	234
AF-area mode .....	99	<b>16</b> Aperture stop indicator.....	73, 288
<b>3</b> AF area brackets.....	33, 37, 179	<b>17</b> Exposure indicator .....	78
<b>4</b> Focus indicator .....	38, 102, 103	Exposure compensation display .....	112
<b>5</b> Metering.....	109	Roll indicator.....	243
<b>6</b> Autoexposure (AE) lock.....	110	<b>18</b> Low battery warning .....	35
<b>7</b> Shutter speed .....	76, 78	<b>19</b> Exposure and flash bracketing indicator .....	153
Autofocus mode.....	97	WB bracketing indicator .....	156
<b>8</b> Aperture (f-number) .....	77, 78	ADL bracketing indicator.....	158
Aperture (number of stops) .....	73, 288	<b>20</b> Auto ISO sensitivity indicator .....	108
<b>9</b> Flash compensation indicator .....	148	<b>21</b> Number of exposures remaining.....	36
<b>10</b> Exposure compensation indicator.....	112	Number of shots remaining before memory	
<b>11</b> ISO sensitivity indicator.....	105	buffer fills .....	38, 84, 335
<b>12</b> ISO sensitivity.....	105	Preset white balance recording indicator.....	122
Active D-Lighting amount.....	138	Exposure compensation value .....	112
AF-area mode .....	99	Flash compensation value.....	148
<b>13</b> Flash-ready indicator .....	39, 231	<b>22</b> "K" (appears when memory remains for over	
		1000 exposures) .....	36

## No Battery

When the battery is totally exhausted or no battery is inserted, the display in the viewfinder will dim. This is normal and does not indicate a malfunction. The viewfinder display will return to normal when a fully-charged battery is inserted.

## The Control Panel and Viewfinder Displays

The brightness of the control panel and viewfinder displays varies with temperature, and the response times of the displays may drop at low temperatures. This is normal and does not indicate a malfunction.

# The Information Display

Press the **Info** button to display shutter speed, aperture, the number of exposures remaining, AF-area mode, and other shooting information in the monitor.

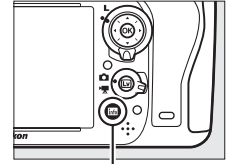

**Info** button

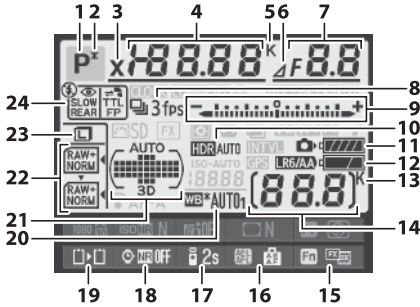

<b>1</b>	Shooting mode .....	35, 40, 73
<b>2</b>	Flexible program indicator .....	75
<b>3</b>	Flash sync indicator .....	234
<b>4</b>	Shutter speed .....	76, 78
	Exposure compensation value .....	112
	Flash compensation value .....	148
	Number of shots in exposure and flash bracketing sequence .....	153
	Number of shots in WB bracketing sequence .....	156
	Focal length (non-CPU lenses) .....	172
	Color temperature .....	115, 120
<b>5</b>	Color temperature indicator .....	120
<b>6</b>	Aperture stop indicator .....	73, 288
<b>7</b>	Aperture (f-number) .....	77, 78
	Aperture (number of stops) .....	73, 288
	Bracketing increment .....	154, 155
	Number of shots in ADL bracketing sequence .....	158
	Maximum aperture (non-CPU lenses) .....	174

<b>8</b>	Release mode .....	6, 83
	Continuous shooting speed .....	229
<b>9</b>	Exposure indicator .....	78
	Exposure compensation display .....	112
	Bracketing progress indicator Exposure and flash bracketing .....	153
	WB bracketing .....	156
<b>10</b>	HDR indicator .....	140
	HDR exposure differential .....	140
<b>11</b>	Camera battery indicator .....	35
<b>12</b>	MB-D14 battery type display .....	232
	MB-D14 battery indicator .....	232
<b>13</b>	"K" (appears when memory remains for over 1000 exposures) .....	36
<b>14</b>	Number of exposures remaining .....	36
	Time-lapse recording indicator .....	170
	Manual lens number .....	174
<b>15</b>	<b>Fn</b> button assignment .....	242
<b>16</b>	<b>AE-L/AF-L</b> button assignment .....	244
<b>17</b>	Remote control mode .....	85
<b>18</b>	Long exposure noise reduction indicator .....	218
<b>19</b>	Role played by card in slot 2 .....	96
<b>20</b>	White balance .....	115
	White balance fine-tuning indicator .....	118
<b>21</b>	Auto-area AF indicator .....	100
	Focus points indicator .....	101
	AF-area mode indicator .....	100
	3D-tracking indicator .....	100
<b>22</b>	Image quality .....	93
<b>23</b>	Image size .....	95
<b>24</b>	Flash mode .....	144



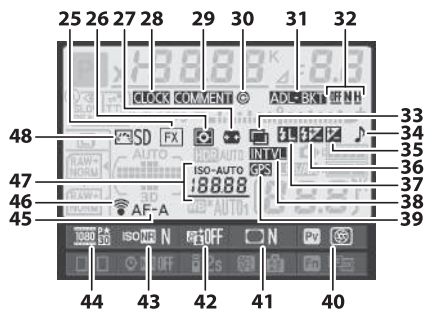



25	Image area indicator .....	90
26	Metering .....	109
27	Auto distortion control .....	217
28	"Clock not set" indicator .....	28, 253
29	Image comment indicator .....	253
30	Copyright information .....	256
31	Exposure and flash bracketing indicator .....	153
	WB bracketing indicator .....	156
	ADL bracketing indicator .....	158

32	ADL bracketing amount .....	138
33	Multiple exposure indicator .....	162
34	"Beep" indicator .....	228
35	Exposure compensation indicator .....	112
36	Flash compensation indicator .....	148
37	FV lock indicator .....	149
38	Interval timer indicator .....	166
	Time-lapse indicator .....	170
39	GPS connection indicator .....	175
40	Depth-of-field preview button assignment .....	244
41	Vignette control indicator .....	218
42	Active D-Lighting indicator .....	138
43	High ISO noise reduction indicator .....	218
44	Movie settings .....	65
45	Autofocus mode .....	97
46	Eye-Fi connection indicator .....	260
47	ISO sensitivity indicator .....	105
	ISO sensitivity .....	105
	Auto ISO sensitivity indicator .....	108
48	Picture Control indicator .....	130

**Turning the Monitor Off**

To clear shooting information from the monitor, press the  button twice more or press the shutter-release button halfway. The monitor will turn off automatically if no operations are performed for about 10 seconds.

**See Also**

For information on choosing how long the monitor stays on, see Custom Setting c4 (**Monitor off delay**,  228). For information on changing the color of the lettering in the information display, see Custom Setting d8 (**Information display**,  231).



## ■ Changing Settings in the Information Display

To change settings for the items listed below, press the **Info** button in the information display. Highlight items using the multi selector and press **OK** to view options for the highlighted item.

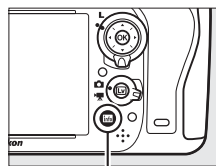

**Info** button

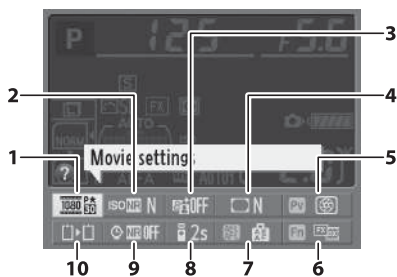

1	Movie settings .....	65
2	High ISO noise reduction .....	218
3	Active D-Lighting .....	137
4	Vignette control .....	218
5	Depth-of-field preview button assignment .....	244
6	<b>Fn</b> button assignment .....	242
7	<b>AE-L/AF-L</b> button assignment .....	244
8	Remote control mode .....	85
9	Long exposure noise reduction .....	218
10	Role played by card in Slot 2.....	96

### Tool Tips

A tool tip giving the name of the selected item appears in the information display. Tool tips can be turned off using Custom Setting d4 (**Screen Tips**;  229).



# The Command Dials

The main- and sub-command dials are used alone or in combination with other controls to adjust a variety of settings.

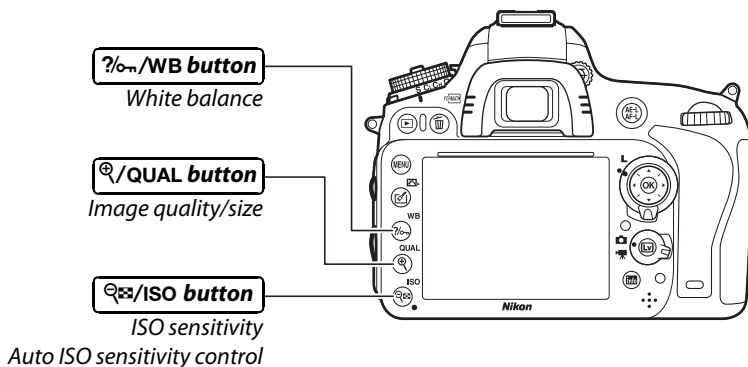
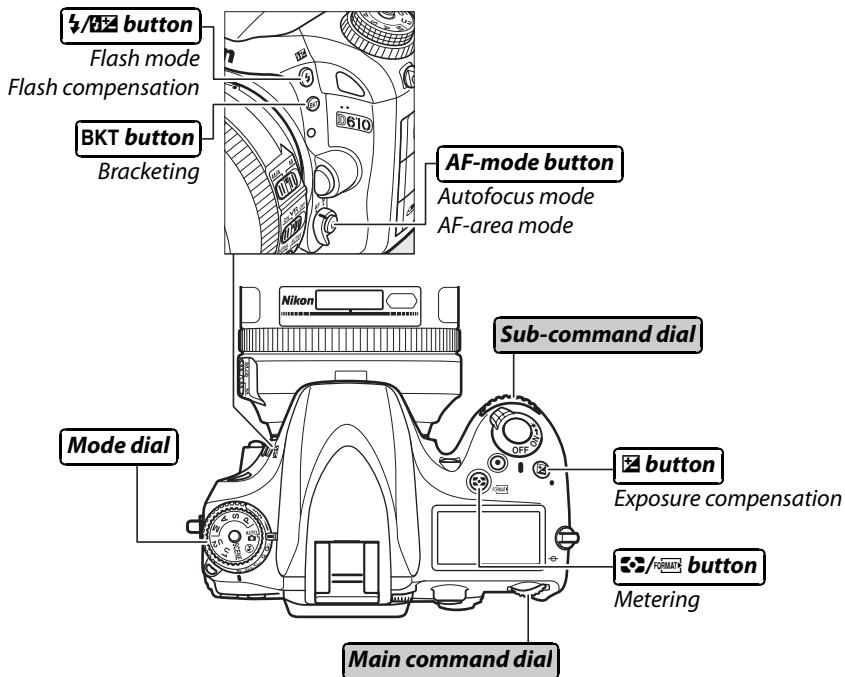

## ■ Scene Mode

Choose a scene (SCENE; 40).

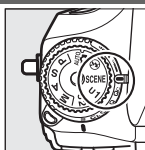

SCENE mode



Main command dial



Monitor

## ■ Image Quality and Size

Set image quality (93).

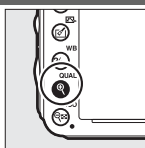

(QUAL) button



Main command dial



Control panel

Choose an image size (95).

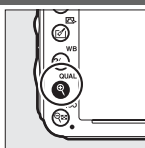

(QUAL) button



Sub-command dial

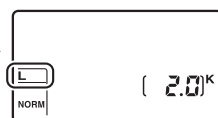

Control panel

## ■ Autofocus

Choose an autofocus mode (98).

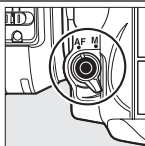

AF-mode button



Main command dial

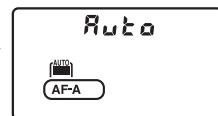

Control panel

Choose an AF-area mode (100).

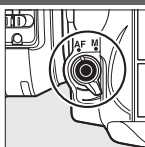

AF-mode button

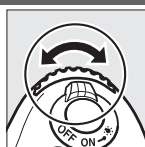

Sub-command dial

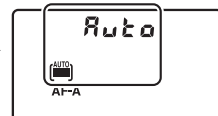

Control panel



## ISO Sensitivity

Set ISO sensitivity (☞ 105).

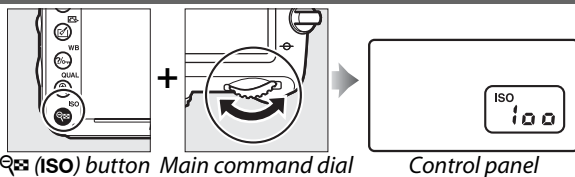

Set auto ISO sensitivity control (☞ 107).

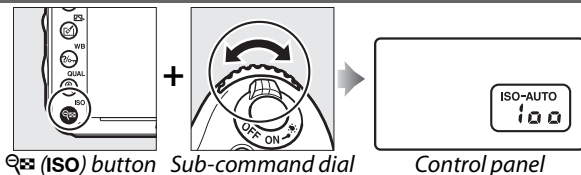

## Exposure

Choose a combination of aperture and shutter speed (mode P; ☞ 75).

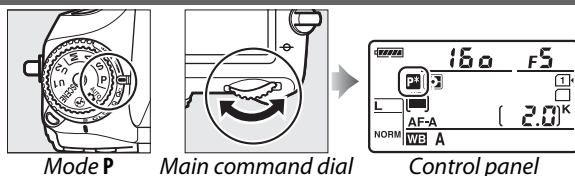

Choose a shutter speed (mode S or M; ☞ 76, 78).

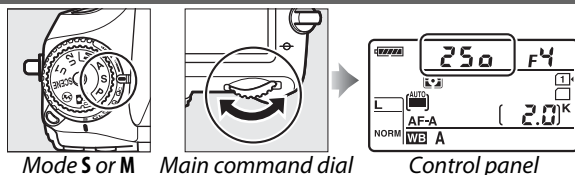

Choose an aperture (mode A or M; ☞ 77, 78).

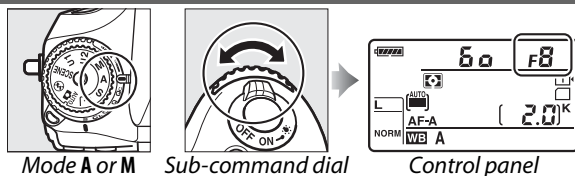

Choose a metering option (mode P, S, A, or M; ☞ 109).

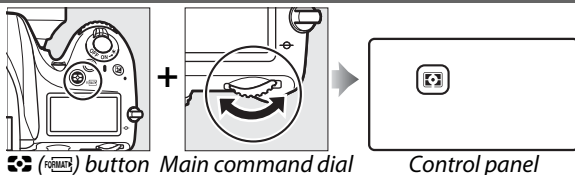

Set exposure compensation  
(mode **P**, **S**, **A**, or **M**; 112).

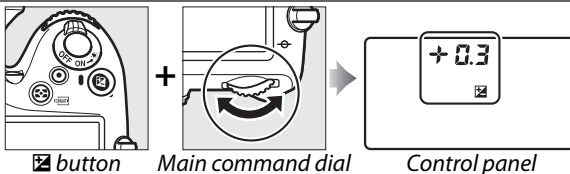

button

Main command dial

Control panel

Activate or cancel bracketing/  
select number of shots in  
bracketing sequence (mode **P**, **S**,  
**A**, or **M**; 153).

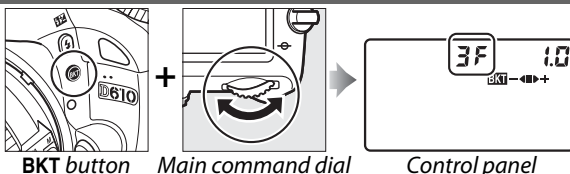

**BKT** button

Main command dial

Control panel

Select bracketing increment  
(mode **P**, **S**, **A**, or **M**; 154).

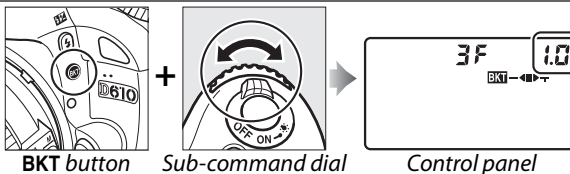

**BKT** button

Sub-command dial

Control panel

## ■ ■ White Balance

Choose a white balance option  
(mode **P**, **S**, **A**, or **M**; 115).

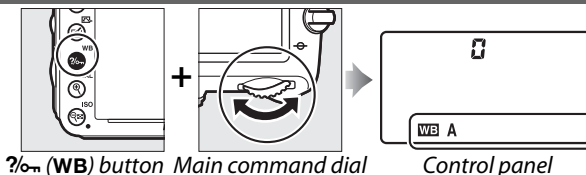

(WB) button

Main command dial

Control panel

Fine-tune white balance  
( 117), set color temperature  
( 120), or choose a white  
balance preset ( 121) in mode  
**P**, **S**, **A**, or **M**.



(WB) button

Sub-command dial

Control panel



## Flash Settings

Choose a flash mode (□ 144).

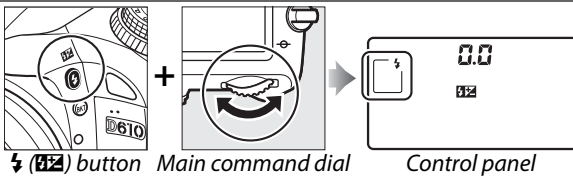

Set flash compensation (mode P, S, A, or M; □ 148).

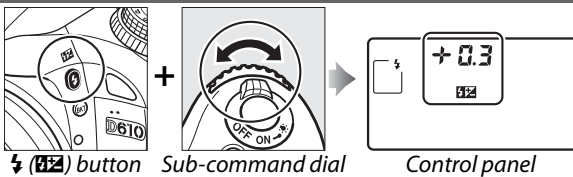

# The BM-14 Monitor Cover

A clear plastic cover is provided with the camera to keep the monitor clean and protect it when the camera is not in use. To attach the cover, insert the projection on the top of the cover into the matching indentation above the camera monitor (①) and press the bottom of the cover until it clicks into place (②).

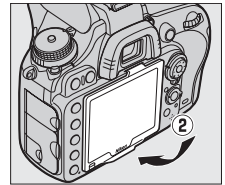
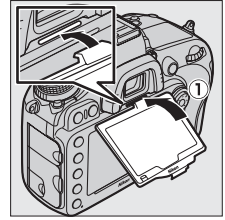

To remove the cover, hold the camera firmly and pull the bottom of the cover gently outwards as shown at right.

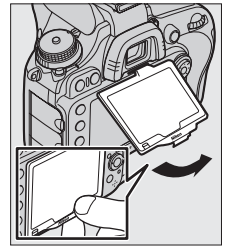

# Camera Menus

Most shooting, playback, and setup options can be accessed from the camera menus. To view the menus, press the **MENU** button.

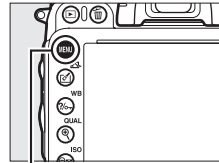

MENU button

## Tabs

Choose from the following menus:

- : **Playback** (book 207)
- : **Shooting** (book 214)
- : **Custom Settings** (book 219)
- : **Setup** (book 249)
- : **Retouch** (book 261)
- : **My Menu** or **Recent settings** (defaults to **My Menu**; book 280)

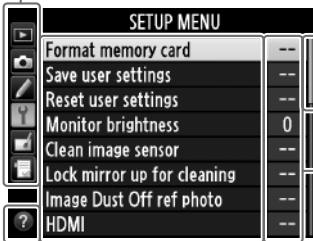

Slider shows position in current menu.

Current settings are shown by icons.

### Menu options

Options in current menu.



If a icon is displayed at the bottom left corner of the monitor, help can be displayed by pressing the (**WB**) button. A description of the currently selected option or menu will be displayed while the button is pressed. Press or to scroll through the display.

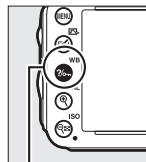

(**WB**) button

### ? Multiple exposure

Record the specified number of shots as a single image. The standby timer is extended by 30 s. If the timer expires, shooting will end and a multiple exposure will be created from any shots that have been taken.



# Using Camera Menus

The multi selector and **OK** button are used to navigate the camera menus.

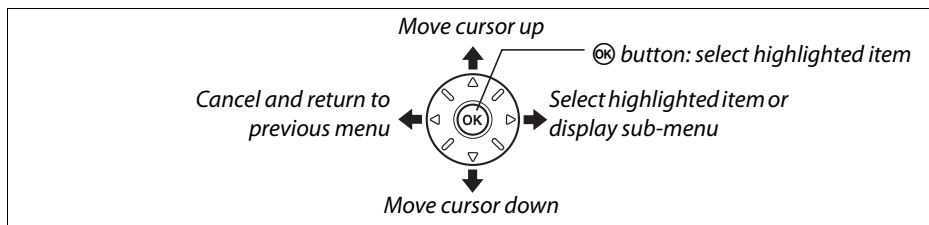

Follow the steps below to navigate the menus.

## 1 Display the menus.

Press the **MENU** button to display the menus.

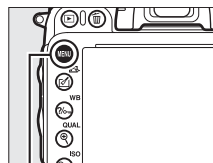

**MENU** button

## 2 Highlight the icon for the current menu.

Press **◀** to highlight the icon for the current menu.



## 3 Select a menu.

Press **▲** or **▼** to select the desired menu.



## 4 Position the cursor in the selected menu.

Press **▶** to position the cursor in the selected menu.



---

## 5 Highlight a menu item.

Press ▲ or ▼ to highlight a menu item.

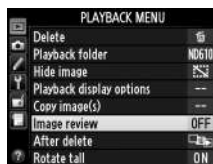

---

## 6 Display options.

Press ► to display options for the selected menu item.



---

## 7 Highlight an option.

Press ▲ or ▼ to highlight an option.



---

## 8 Select the highlighted item.

Press **OK** to select the highlighted item. To exit without making a selection, press the **MENU** button.



Note the following:

- Menu items that are displayed in gray are not currently available.
- While pressing ► generally has the same effect as pressing **OK**, there are some cases in which selection can only be made by pressing **OK**.
- To exit the menus and return to shooting mode, press the shutter-release button halfway (☐ 39).

# First Steps

## Charge the Battery

The camera is powered by an EN-EL15 rechargeable Li-ion battery (supplied). To maximize shooting time, charge the battery in the supplied MH-25 battery charger before use. About 2 hours and 35 minutes are required to fully recharge the battery when no charge remains.

### 1 Connect the AC power cable.

Connect the power cable. The AC adapter plug should be in the position shown at right; do not rotate.

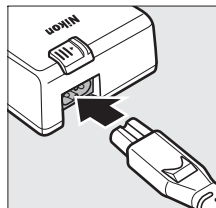

### 2 Remove the terminal cover.

Remove the terminal cover from the battery.

### 3 Insert the battery.

Place the battery in the battery bay as shown in the illustration on the charger.

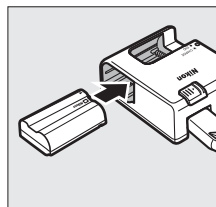

### 4 Plug the charger in.

The **CHARGE** lamp will flash slowly while the battery charges.

#### Charging the Battery

Charge the battery indoors at ambient temperatures between 5°C–35°C (41°F–95°F). The battery will not charge if its temperature is below 0°C (32°F) or above 60°C (140°F).

*Battery charging*      *Charging complete*

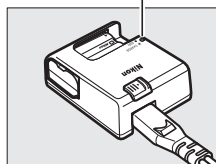
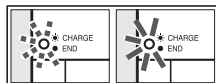

### 5 Remove the battery when charging is complete.

Charging is complete when the **CHARGE** lamp stops flashing. Unplug the charger and remove the battery.



### **The AC Wall Adapter**

Depending on the country or region of purchase, an AC wall adapter may also be supplied with the charger. To use the adapter, insert it into the charger AC inlet (1). Slide the AC wall adapter latch in the direction shown (2) and rotate the adapter 90° to fix it in the position shown (3). Reverse these steps to remove the adapter.

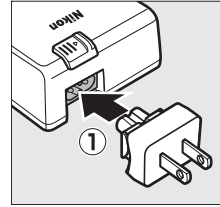

*AC wall adapter  
latch*

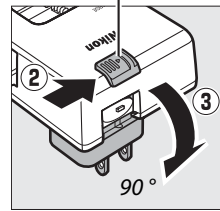

# Insert the Battery

Before inserting the battery, rotate the power switch to **OFF**.

## ✔ Inserting and Removing Batteries

Always turn the camera off before inserting or removing batteries.

### 1 Open the battery-chamber cover.

Unlatch (①) and open (②) the battery-chamber cover.

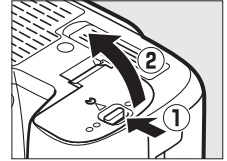

### 2 Insert the battery.

Insert the battery in the orientation shown (①), using the battery to keep the orange battery latch pressed to one side. The latch locks the battery in place when the battery is fully inserted (②).

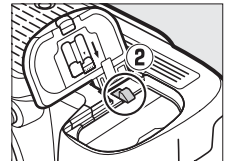
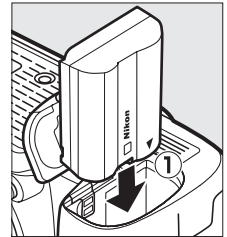

Battery latch

### 3 Close the battery-chamber cover.

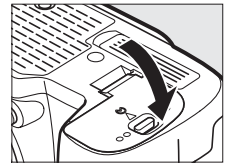

## ✎ Removing the Battery

Turn the camera off and open the battery-chamber cover. Press the battery latch in the direction shown by the arrow to release the battery and then remove the battery by hand.

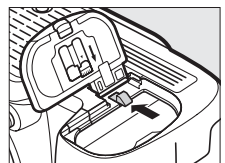

## **The Battery and Charger**

*Read and follow the warnings and cautions on pages xviii–xix and 306–308 of this manual. Do not use the battery at ambient temperatures below 0°C (32°F) or above 40°C (104°F); failure to observe this precaution could damage the battery or impair its performance. Capacity may be reduced and charging times may increase at battery temperatures from 0°C (32°F) to 15°C (59°F) and from 45°C (113°F) to 60°C (140°F).*

If the **CHARGE** lamp flashes quickly (about eight times a second) during charging, confirm that the temperature is in the correct range and then unplug the charger and remove and reinsert the battery. If the problem persists, cease use immediately and take battery and charger to your retailer or a Nikon-authorized service representative.

Do not short the charger terminals; failure to observe this precaution could result in overheating and damage to the charger. Do not move the charger or touch the battery during charging. Failure to observe this precaution could in very rare instances result in the charger showing that charging is complete when the battery is only partially charged. Remove and reinsert the battery to begin charging again. Battery capacity may temporarily drop if the battery is charged at low temperatures or used at a temperature below the temperature at which it was charged. If the battery is charged at a temperature below 5 °C (41 °F), the battery life indicator in the **Battery info** (☐ 255) display may show a temporary decrease.

The battery may be hot immediately after use. Wait for the battery to cool before recharging.

The supplied power cable and AC wall adapter are for use with the MH-25 only. Use the charger with compatible batteries only. Unplug when not in use.

A marked drop in the time a fully charged battery retains its charge when used at room temperature indicates that it requires replacement. Purchase a new EN-EL15 battery.

### **EN-EL15 Rechargeable Li-ion Batteries**

The supplied EN-EL15 shares information with compatible devices, enabling the camera to show battery charge state in six levels (☐ 35). The **Battery info** option in the setup menu details battery charge, battery life, and the number of pictures taken since the battery was last charged (☐ 255).

# Attach a Lens

Care should be taken to prevent dust from entering the camera when the lens is removed. The lens generally used in this manual for illustrative purposes is an AF-S NIKKOR 24-120mm f/4G ED VR.

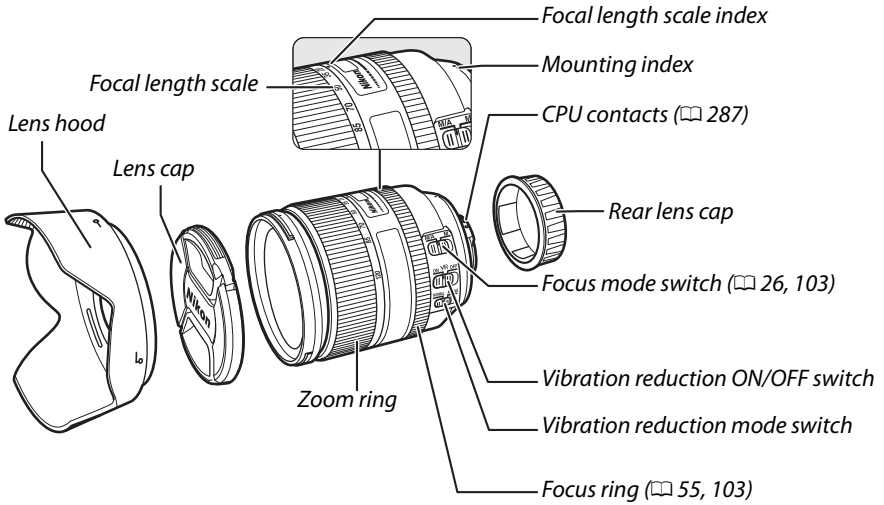

---

**1** Turn the camera off.

---

**2** Remove the rear lens cap and the camera body cap.

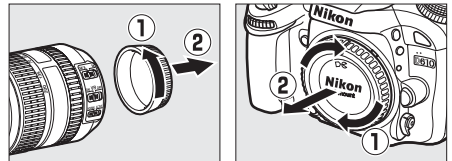

### 3 Attach the lens.

Keeping the mounting index on the lens aligned with the mounting index on the camera body, position the lens in the camera's bayonet mount (1). Being careful not to press the lens-release button, rotate the lens counter-clockwise until it clicks into place (2).

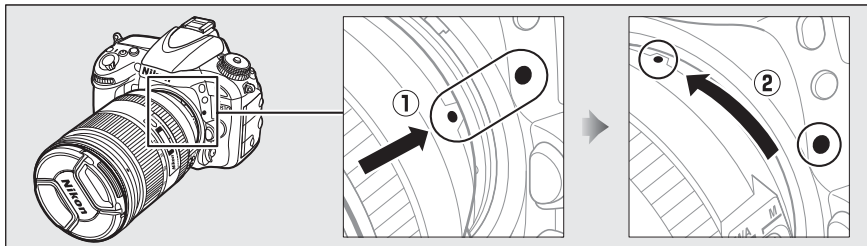

If the lens is equipped with a focus mode switch, select autofocus mode (A, M/A, or A/M).



#### Detaching the Lens

Be sure the camera is off when removing or exchanging lenses. To remove the lens, press and hold the lens release button (1) while turning the lens clockwise (2). After removing the lens, replace the lens caps and camera body cap.

#### CPU Lenses with Aperture Rings

In the case of CPU lenses equipped with an aperture ring (□ 287), lock aperture at the minimum setting (highest f-number).

#### Image Area

The DX format image area is automatically selected when a DX lens is attached (□ 89).

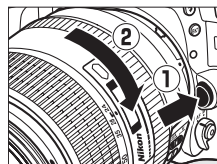

Image area



# Basic Setup

A language-selection dialog will be displayed the first time the camera is turned on. Choose a language and set the time and date. Photographs can not be taken until you have set the time and date.

## 1 Turn the camera on.

A language-selection dialog will be displayed.

## 2 Select a language.

Press ▲ or ▼ to highlight the desired language and press **OK**.



## 3 Choose a time zone.

A time-zone selection dialog will be displayed. Press ◀ or ▶ to highlight the local time zone (the **UTC** field shows the difference between the selected time zone and Coordinated Universal Time, or UTC, in hours) and press **OK**.



## 4 Choose a date format.

Press ▲ or ▼ to choose the order in which the year, month, and day will be displayed. Press **OK** to proceed to the next step.

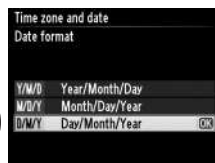

## 5 Turn daylight saving time on or off.

Daylight saving time options will be displayed. Daylight saving time is off by default; if daylight saving time is in effect in the local time zone, press ▲ to highlight **On** and press **OK**.

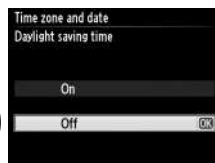

## 6 Set the date and time.

The dialog shown at right will be displayed. Press ◀ or ▶ to select an item, ▲ or ▼ to change. Press **OK** to set the clock and exit to shooting mode.

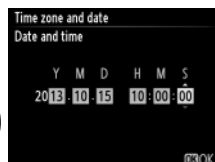

### **Setting the Clock**

Language and date/time settings can be changed at any time using the **Language** (☞ 253) and **Time zone and date** (☞ 253) options in the setup menu. The camera clock can also be synchronized with GPS devices (☞ 175).

### **The Clock Battery**

The camera clock is powered by an independent, rechargeable power source, which is charged as necessary when the main battery is installed or the camera is powered by an optional EP-5B power connector and EH-5b AC adapter (☞ 297). Two days of charging will power the clock for about three months. If the camera displays a warning at startup stating that the clock is not set and a  icon flashes in the information display, the clock battery is exhausted and the clock has been reset. Set the clock to the correct time and date.

### **The Camera Clock**

The camera clock is less accurate than most watches and household clocks. Check the clock regularly against more accurate time pieces and reset as necessary.

# Insert a Memory Card

The camera stores pictures on Secure Digital (SD) memory cards (available separately; □ 334). The camera has two memory card slots (Slot 1 and Slot 2); if you will be using only one memory card, insert it in Slot 1 (□ 30).

## 1 Turn the camera off.

### Inserting and Removing Memory Cards

Always turn the camera off before inserting or removing memory cards.

## 2 Open the card slot cover.

Slide the card slot cover out (①) and open the card slot (②).

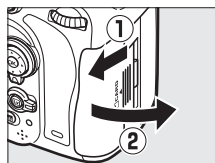

## 3 Insert the memory card.

Holding the memory card as shown at right, slide it in until it clicks into place. The memory card access lamp will light for a few seconds.

### Inserting Memory Cards

Inserting memory cards upside down or backwards could damage the camera or the card. Check to be sure the card is in the correct orientation. The card slot cover will not close if the card is not correctly inserted.

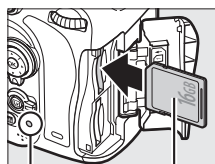

Front

Memory card access lamp

Close the memory card slot cover. If this is the first time the memory card will be used in the camera or the card has been formatted in another device, format the card as described on page 31.

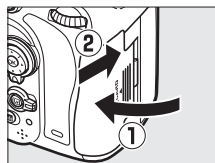

### Removing Memory Cards

After confirming that the memory card access lamp is off, turn the camera off, open the memory card slot cover, and press the card in to eject it (①). The card can then be removed by hand (②).

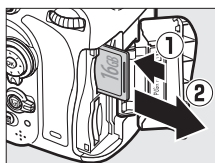

## No Memory Card

If the camera is turned off with a charged EN-EL15 battery and no memory card inserted, (- E -) will be displayed in the control panel and viewfinder.

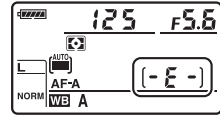

## Using Two Memory Cards

Slot 1 is for the main card; the card in slot 2 plays a backup or secondary role. If the default setting of **Overflow** is selected for **Role played by card in Slot 2** (☐ 96) when two memory cards are inserted, the card in slot 2 will only be used when the card in slot 1 is full.

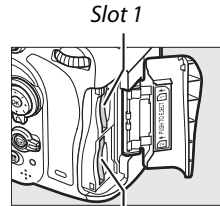

Slot 2

The control panel shows the slot or slots that currently hold a memory card (the example at right shows the icons displayed when a card is inserted in each slot). If the memory card is full or locked or an error has occurred, the icon for the affected card will flash (☐ 324).

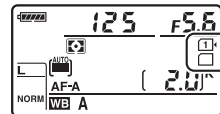

Control panel



Information display

## Memory Cards

- Memory cards may be hot after use. Observe due caution when removing memory cards from the camera.
- Turn the power off before inserting or removing memory cards. Do not remove memory cards from the camera, turn the camera off, or remove or disconnect the power source during formatting or while data are being recorded, deleted, or copied to a computer. Failure to observe these precautions could result in loss of data or in damage to the camera or card.
- Do not touch the card terminals with your fingers or metal objects.
- Do not bend, drop, or subject to strong physical shocks.
- Do not apply force to the card casing. Failure to observe this precaution could damage the card.
- Do not expose to water, heat, high levels of humidity, or direct sunlight.
- Do not format memory cards in a computer.

# Format the Memory Card





Memory cards must be formatted before first use or after being used or formatted in other devices.

## Formatting Memory Cards



Formatting memory cards permanently deletes any data they may contain. Be sure to copy any photographs and other data you wish to keep to a computer before proceeding (193).

### 1 Turn the camera on.

### 2 Press the (FORMAT) and (FORMAT) buttons.

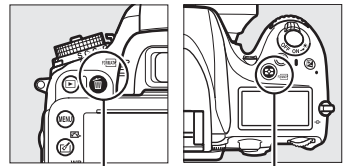

Hold the  (FORMAT) and  (FORMAT) buttons down simultaneously until a flashing **F o r** (format) appears in the shutter-speed displays in the control panel and viewfinder. If two memory cards are inserted, the card in Slot 1 (130) will be selected; you can choose the card in Slot 2 by rotating the main command dial. To exit without formatting the memory card, wait until **F o r** stops flashing (about six seconds) or press any button other than the  (FORMAT) and  (FORMAT) buttons.

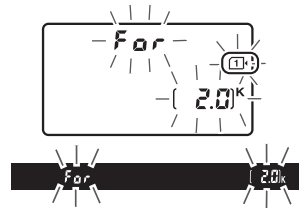

 (FORMAT) button  (FORMAT) button



### 3 Press the (FORMAT) and (FORMAT) buttons again.

Press the  (FORMAT) and  (FORMAT) buttons together a second time while **F o r** is flashing to format the memory card. *Do not remove the memory card or remove or disconnect the power source during formatting.*

When formatting is complete, the control panel and viewfinder will show the number of photographs that can be recorded at current settings.



### **The Write Protect Switch**

SD memory cards are equipped with a write protect switch to prevent accidental loss of data. When this switch is in the “lock” position, the memory card can not be formatted and photos can not be deleted or recorded (a warning will be displayed in the monitor if you attempt to release the shutter). To unlock the memory card, slide the switch to the “write” position.

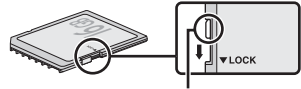

*Write-protect switch*

### **See Also**

See page 250 for information on formatting memory cards using the **Format memory card** option in the setup menu.



# Adjust Viewfinder Focus

The camera is equipped with diopter adjustment to accommodate individual differences in vision. Check that the display in the viewfinder is in focus before framing pictures in the viewfinder.

## 1 Turn the camera on.

Remove the lens cap and turn the camera on.



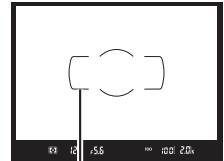
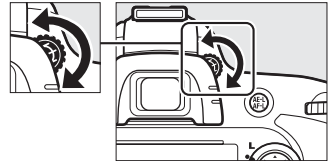

## 2 Focus the viewfinder.

Rotate the diopter adjustment control until the AF area brackets are in sharp focus. When operating the diopter adjustment control with your eye to the viewfinder, be careful not to put your fingers or fingernails in your eye.



*AF area brackets*

### Adjusting Viewfinder Focus

If you are unable to focus the viewfinder as described above, select single-servo autofocus (**AF-S**; ) 97), single-point AF () 99), and the center focus point () 101), and then frame a high-contrast subject in the center focus point and press the shutter-release button halfway to focus the camera. With the camera in focus, use the diopter adjustment control to bring the subject into clear focus in the viewfinder. If necessary, viewfinder focus can be further adjusted using optional corrective lenses () 297).







# Basic Photography and Playback

## “Point-and-Shoot” Photography

### ( and Modes)

This section describes how to take photographs in (auto) mode, an automatic “point-and-shoot” mode in which the majority of settings are controlled by the camera in response to shooting conditions, and in which the flash will fire automatically if the subject is poorly lit. To take photographs with the flash off while leaving the camera in control of other settings, rotate the mode dial to to select auto (flash off) mode.



## Step 1: Turn the Camera On

### 1 Turn the camera on.

Remove the lens cap and turn the camera on. The control panel will turn on and the display in the viewfinder will light.

### 2 Check the battery level.

Check the battery level in the control panel or viewfinder.

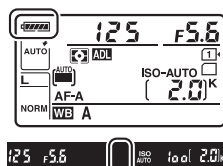

Control panel*	Viewfinder*	Description
	—	Battery fully charged.
	—	Battery partially discharged.
	—	
		Low battery. Charge battery or ready spare battery.
(flashes)	(flashes)	Shutter release disabled. Charge or exchange battery.

\* No icon displayed when camera is powered by optional EP-5B power connector and EH-5b AC adapter. appears in information display.

### Image Sensor Cleaning

The camera vibrates the low-pass filter covering the image sensor to remove dust when the camera is turned on or off (☐ 301).

### 3 Check the number of exposures remaining.

The control panel and viewfinder show the number of photographs that can be taken at current settings (values over 1,000 are rounded down to the nearest hundred; e.g., values between 2,000 and 2,099 are shown as 2.0 K). If two memory cards are inserted, the displays show the space available on the card in Slot 1 (📄 30). When the number of exposures remaining reaches 0, the number will flash, **FULL** or **FuL** will flash in the shutter-speed displays, and the icon for the affected card will flash. Insert another memory card (📄 29) or delete some photos (📄 47, 189).

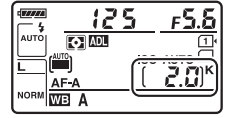

## Step 2: Select <sup>AUTO</sup> or ⚡ Mode

To shoot where use of a flash is prohibited, photograph infants, or capture natural lighting under low light conditions, rotate the mode dial to ⚡. Otherwise, rotate the mode dial to <sup>AUTO</sup>.

Mode dial

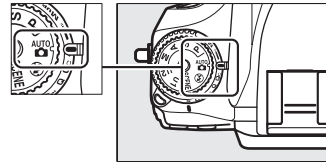

⚡ mode



<sup>AUTO</sup> mode

### 🔪 Camera Off Display

If the camera is turned off with a battery and memory card inserted, the memory card icon and number of exposures remaining will be displayed (some memory cards may in rare cases only display this information when the camera is on).

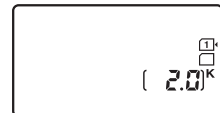

Control panel

# Step 3: Frame the Photograph

## 1 Ready the camera.

When framing photographs in the viewfinder, hold the handgrip in your right hand and cradle the camera body or lens with your left. Keep your elbows propped lightly against your torso for support and place one foot half a pace ahead of the other to keep your upper body stable. When framing photographs in portrait (tall) orientation, hold the camera as shown in the bottom of the three illustrations at right.

In  $\text{Ⓢ}$  mode, shutter speeds slow when lighting is poor; use of a tripod is recommended.

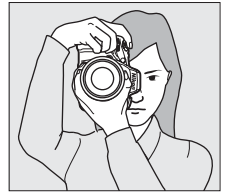
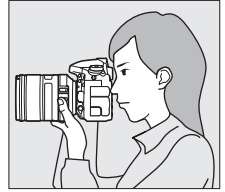
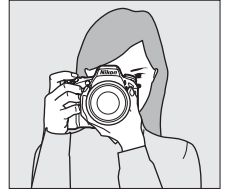

## 2 Frame the photograph.

Frame a photograph in the viewfinder with the main subject in the AF area brackets.

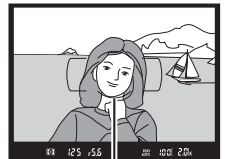

AF area brackets

### Using a Zoom Lens

Use the zoom ring to zoom in on the subject so that it fills a larger area of the frame, or zoom out to increase the area visible in the final photograph (select longer focal lengths on the lens focal length scale to zoom in, shorter focal lengths to zoom out).

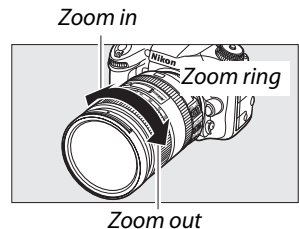

## Step 4: Focus

### 1 Press the shutter-release button halfway.

Press the shutter-release button halfway to focus. The active focus point will be displayed. If the subject is poorly lit, the flash may pop up and the AF-assist illuminator may light.



### 2 Check the indicators in the viewfinder.

When the focus operation is complete, the in-focus indicator (●) will appear in the viewfinder.

In-focus indicator	Description
●	Subject in focus.
▶	Focus point is between camera and subject.
◀	Focus point is behind subject.
▶◀ (flashes)	Camera unable to focus using autofocus. See page 98.

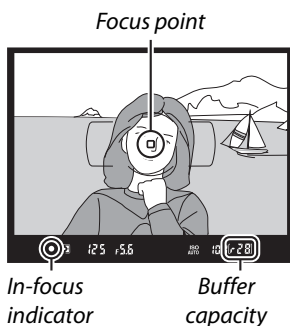

While the shutter-release button is pressed halfway, the number of exposures that can be stored in the memory buffer ("84") will be displayed in the viewfinder.

## Step 5: Shoot

Smoothly press the shutter-release button the rest of the way down to release the shutter and record the photograph. The memory card access lamp next to the memory card slot cover will light while the photograph is being recorded to the memory card. *Do not eject the memory card or remove or disconnect the power source until the lamp has gone out and recording is complete.*

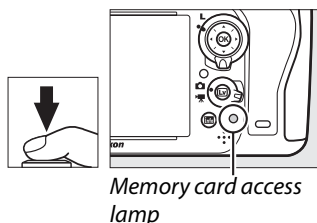

## The Shutter-Release Button

The camera has a two-stage shutter-release button. The camera focuses when the shutter-release button is pressed halfway. To take the photograph, press the shutter-release button the rest of the way down.



*Focus: press halfway*



*Shoot: press all the way down*

## The Standby Timer

The viewfinder and the control panel shutter speed and aperture displays will turn off if no operations are performed for about 6 seconds, reducing the drain on the battery. Press the shutter-release button halfway to reactivate the display. The length of time before the standby timer expires automatically can be selected using Custom Setting c2 (**Standby timer**,  227).

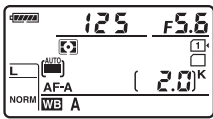

*Exposure meters on*

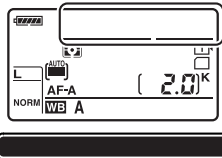

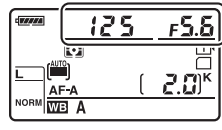

*Exposure meters off*



*Exposure meters on*

## The Built-in Flash

If additional lighting is required for correct exposure in  mode, the built-in flash will pop up automatically when the shutter-release button is pressed halfway. If the flash is raised, photographs can only be taken when the flash-ready indicator () is displayed. If the flash-ready indicator is not displayed, the flash is charging; remove your finger briefly from the shutter-release button and try again.

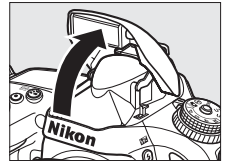

To save power when the flash is not in use, press it gently downward until the latch clicks into place.

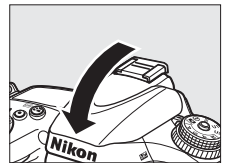

# Creative Photography (Scene Modes)

The camera offers a choice of “scene” modes. Choosing a scene mode automatically optimizes settings to suit the selected scene, making creative photography as simple as selecting a mode, framing a picture, and shooting as described on pages 35–39.



## ■■ SCENE Mode

To view the currently selected scene, rotate the mode dial to **SCENE** and press the **info** button. To choose another scene, rotate the main command dial.



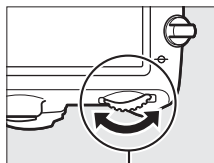
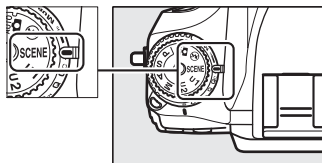















Mode dial



Main command dial



Monitor

Portrait 	Landscape 	Child 	Sports 	Close up 	Night portrait 	Night landscape 
Party/indoor 	Beach/snow 	Sunset 	Dusk/dawn 	Pet portrait 	Candlelight 	Blossom 
Autumn colors 	Food 	Silhouette 	High key 	Low key 		

## ■ Scene Modes

### Portrait



Use for portraits with soft, natural-looking skin tones. If the subject is far from the background or a telephoto lens is used, background details will be softened to lend the composition a sense of depth.

### Landscape



Use for vivid landscape shots in daylight. The built-in flash and AF-assist illuminator turn off; use of a tripod is recommended to prevent blur when lighting is poor.

### Child



Use for snapshots of children. Clothing and background details are vividly rendered, while skin tones remain soft and natural.

### Sports



Fast shutter speeds freeze motion for dynamic sports shots in which the main subject stands out clearly. The built-in flash and AF-assist illuminator turn off. To take a sequence of shots, select continuous release mode ( 6, 83).



### **Close Up**



 Use for close-up shots of flowers, insects, and other small objects (a macro lens can be used to focus at very close ranges). Use of a tripod is recommended to prevent blur.

### **Night Portrait**



Use for a natural balance between the main subject and the background in portraits taken under low light. Use of a tripod is recommended to prevent blur when lighting is poor.

### **Night Landscape**



Reduce noise and unnatural colors when photographing night landscapes, including street lighting and neon signs. The built-in flash and AF-assist illuminator turn off; use of a tripod is recommended to prevent blur.

### **Party/Indoor**



Capture the effects of indoor background lighting. Use for parties and other indoor scenes.



### **Beach/Snow**



Capture the brightness of sunlight expanses of water, snow, or sand. The built-in flash and AF-assist illuminator turn off.

### **Sunset**



Preserves the deep hues seen in sunsets and sunrises. The built-in flash and AF-assist illuminator turn off; use of a tripod is recommended to prevent blur when lighting is poor.

### **Dusk/Dawn**



Preserves the colors seen in the weak natural light before dawn or after sunset. The built-in flash and AF-assist illuminator turn off; use of a tripod is recommended to prevent blur when lighting is poor.

### **Pet Portrait**



Use for portraits of active pets. The AF-assist illuminator turns off.



## **Candlelight**



 For photographs taken by candlelight. The built-in flash turns off; use of a tripod is recommended to prevent blur when lighting is poor.

## **Blossom**



Use for fields of flowers, orchards in bloom, and other landscapes featuring expanses of blossoms. The built-in flash turns off; use of a tripod is recommended to prevent blur when lighting is poor.

## **Autumn Colors**



Captures the brilliant reds and yellows in autumn leaves. The built-in flash turns off; use of a tripod is recommended to prevent blur when lighting is poor.

## **Food**



Use for vivid photographs of food. Use of a tripod is recommended to prevent blur; the flash can also be used (☞ 143).

## **Silhouette**



Silhouette subjects against bright backgrounds. The built-in flash turns off; use of a tripod is recommended to prevent blur when lighting is poor.

## **Low Key**



Use when shooting dark scenes to create dark, somber images that bring out highlights. The built-in flash turns off; use of a tripod is recommended to prevent blur when lighting is poor.

## **High Key**



Use when shooting bright scenes to create bright images that seem filled with light. The built-in flash turns off.



# Basic Playback





## 1 Press the button.

A photograph will be displayed in the monitor. The memory card containing the picture currently displayed is shown by an icon.



 button

## 2 View additional pictures.

Additional pictures can be displayed by pressing  or . To view additional information on the current photograph, press  and  (□ 179).

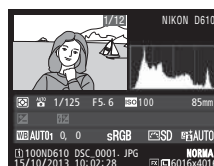

To end playback and return to shooting mode, press the shutter-release button halfway.



### **Image Review**

When **On** is selected for **Image review** in the playback menu (□ 212), photographs are automatically displayed in the monitor for a few seconds after shooting.

### **See Also**

See page 178 for information on choosing a memory card slot.

# Deleting Unwanted Photographs



To delete the photograph currently displayed in the monitor, press the  (**FORMAT**) button. *Note that photographs can not be recovered once deleted.*

## 1 Display the photograph.

Display the photograph you wish to delete as described on the preceding page. The location of the current image is shown by an icon at the bottom left corner of the display.





## 2 Delete the photograph.

Press the  (**FORMAT**) button. A confirmation dialog will be displayed; press the  (**FORMAT**) button again to delete the image and return to playback. To exit without deleting the picture, press .



 (**FORMAT**) button

### Delete

To delete selected images (, 190), all images taken on a selected date (, 191), or all images in a chosen location on a selected memory card (, 190), use the **Delete** option in the playback menu.





# Live View Photography

Follow the steps below to take photographs in live view.

## 1 Rotate the live view selector to (live view photography).

### Cover the Viewfinder

To prevent light entering via the viewfinder from interfering with exposure, remove the rubber eyecup and cover the viewfinder with the supplied DK-5 eyepiece cap before shooting ( 86).

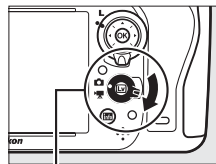

Live view selector

## 2 Press the button.

The mirror will be raised and the view through the lens will be displayed in the camera monitor. The subject will no longer be visible in the viewfinder.

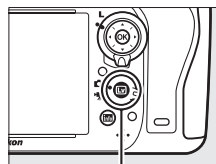

 button



## 3 Position the focus point.

Position the focus point over your subject as described on page 51.

## 4 Focus.

Press the shutter-release button halfway to focus.



The focus point will flash green while the camera focuses. If the camera is able to focus, the focus point will be displayed in green; if the camera is unable to focus, the focus point will flash red (note that pictures can be taken even when the focus point flashes red; check focus in the monitor before shooting). Exposure can be locked by pressing the  **AE-L/AF-L** button ( 110); focus locks while the shutter-release button is pressed halfway. In mode **M**, exposure can be adjusted with the assistance of an exposure indicator ( 78).

 **AE-L/AF-L** button

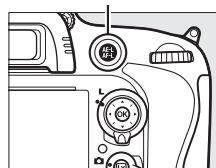

## 5 Take the picture.

Press the shutter-release button the rest of the way down to shoot. The monitor will turn off.



## 6 Exit live view mode.

Press the  button to exit live view mode.

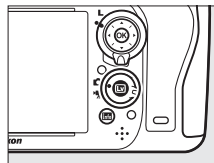





### Ending Live View

Live view ends automatically if the lens is removed. Live view may also end automatically to prevent damage to the camera's internal circuits; exit live view when the camera is not in use. Note that the temperature of the camera's internal circuits may rise and noise (bright spots, randomly-spaced bright pixels, or fog) may be displayed in the following instances (the camera may also become noticeably warm, but this does not indicate a malfunction):



- The ambient temperature is high
- The camera has been used for extended periods in live view or to record movies
- The camera has been used in continuous release mode for extended periods

If live view does not start when you press the  button, wait for the internal circuits to cool and then try again.

### Choosing a Picture Control (P, S, A, and M Modes Only)

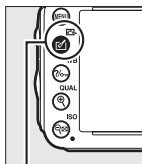
Pressing  () during live view displays a list of Picture Controls. Highlight the desired Picture Control and press  to adjust Picture Control settings ( 129).



 () button

### Movies

Movie recording is not available during live view photography and pressing the movie-record button has no effect. Select movie live view ( 57) to shoot movies.

Lv



# Focusing in Live View

To focus using autofocus, rotate the focus-mode selector to **AF** and follow the steps below to choose autofocus and AF-area modes. For information on focusing manually, see page 55.

Focus-mode selector

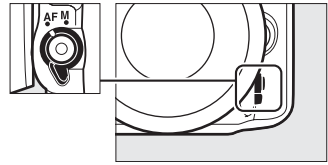

## ■ Choosing a Focus Mode

The following autofocus modes are available in live view:

Mode	Description
AF-S	<b>Single-servo AF:</b> For stationary subjects. Focus locks when shutter-release button is pressed halfway.
AF-F	<b>Full-time servo AF:</b> For moving subjects. Camera focuses continuously until shutter-release button is pressed. Focus locks when shutter-release button is pressed halfway.



To choose an autofocus mode, press the AF-mode button and rotate the main command dial until the desired mode is displayed in the monitor.

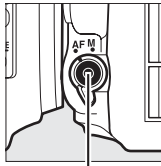

AF-mode button



Main command dial

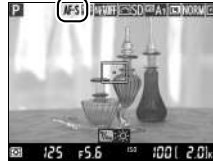

Monitor





### ✓ Using Autofocus in Live View

Use an AF-S lens. The desired results may not be achieved with other lenses or teleconverters. Note that in live view, autofocus is slower and the monitor may brighten or darken while the camera focuses. The focus point may sometimes be displayed in green when the camera is unable to focus. The camera may be unable to focus in the following situations:

- The subject contains lines parallel to the long edge of the frame
- The subject lacks contrast
- The subject in the focus point contains areas of sharply contrasting brightness, or includes spot lighting or a neon sign or other light source that changes in brightness
- Flicker or banding appears under fluorescent, mercury-vapor, sodium-vapor, or similar lighting
- A cross (star) filter or other special filter is used
- The subject appears smaller than the focus point
- The subject is dominated by regular geometric patterns (e.g., blinds or a row of windows in a skyscraper)
- The subject is moving

## ■ ■ Choosing an AF-Area Mode

The following AF-area modes can be selected in live view:

Mode	Description
	<b>Face-priority AF:</b> Use for portraits. The camera automatically detects and focuses on portrait subjects; the selected subject is indicated by a double yellow border (if multiple faces, up to a maximum of 35, are detected, the camera will focus on the closest subject; to choose a different subject, use the multi selector). If the camera can no longer detect the subject (because, for example, the subject has turned to face away from the camera), the border will no longer be displayed.
	<b>Wide-area AF:</b> Use for hand-held shots of landscapes and other non-portrait subjects. Use the multi selector to move the focus point anywhere in the frame, or press <b>OK</b> to position the focus point in the center of the frame.
	<b>Normal-area AF:</b> Use for pin-point focus on a selected spot in the frame. Use the multi selector to move the focus point anywhere in the frame, or press <b>OK</b> to position the focus point in the center of the frame. A tripod is recommended.
	<b>Subject-tracking AF:</b> Position the focus point over your subject and press <b>OK</b> . The focus point will track the selected subject as it moves through the frame. To end tracking, press <b>OK</b> again. Note that the camera may be unable to track subjects if they move quickly, leave the frame or are obscured by other objects, change visibly in size, color, or brightness, or are too small, too large, too bright, too dark, or similar in color or brightness to the background.

To choose an AF-area mode, press the AF-mode button and rotate the sub-command dial until the desired mode is displayed in the monitor.

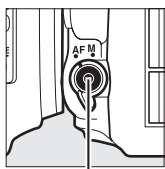

AF-mode button

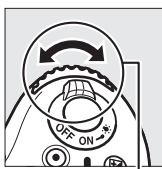

Sub-command dial

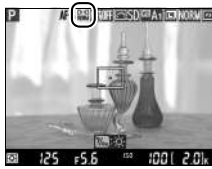

Monitor

# The Live View Display: Live View Photography

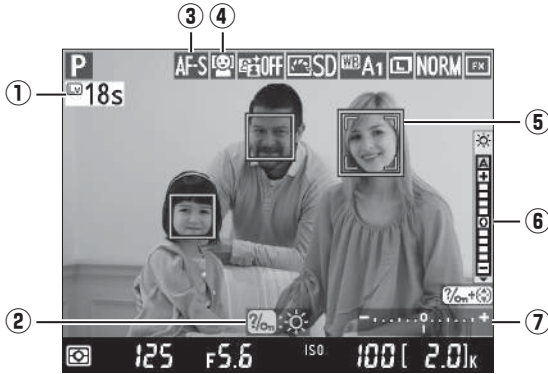

Item	Description	
① Time remaining	The amount of time remaining before live view ends automatically. Displayed if shooting will end in 30 s or less.	56
② Guide	A guide to the options available during live view photography.	—
③ Autofocus mode	The current autofocus mode.	51
④ AF-area mode	The current AF-area mode.	52
⑤ Focus point	The current focus point. The display varies with the option selected for AF-area mode.	49
⑥ Monitor brightness indicator	Keeping the $\frac{1}{6}$ (WB) button pressed, press $\blacktriangle$ or $\blacktriangledown$ to adjust monitor brightness (note that monitor brightness has no effect on photographs taken with the camera). If A (auto) is selected, the camera will automatically adjust brightness in response to ambient lighting conditions as measured by the ambient brightness sensor when the monitor is on (📖 4).	—
⑦ Exposure indicator	Indicates whether the photograph would be under- or overexposed at current settings (mode M only).	78



### ✓ **The Live View Display**

Although they will not appear in the final picture, jagged edges, color fringing, moire, and bright spots may appear in the monitor, while bright bands may appear in some areas with flashing signs and other intermittent light sources or if the subject is briefly illuminated by a strobe or other bright, momentary light source. In addition, distortion may occur if the camera is panned horizontally or an object moves at high speed through the frame. Flicker and banding visible in the monitor under fluorescent, mercury vapor, or sodium lamps can be reduced using **Flicker reduction** (☞ 252), although they may still be visible in the final photograph at some shutter speeds. When shooting in live view mode, avoid pointing the camera at the sun or other strong light sources. Failure to observe this precaution could result in damage to the camera's internal circuitry.

### ✍ **Exposure**

Depending on the scene, exposure may differ from that which would be obtained when live view is not used. Metering in live view is adjusted to suit the live view display, producing photographs with exposure close to what is seen in the monitor. In **P**, **S**, **A**, and **M** modes, exposure can be adjusted by  $\pm 5$  EV (☞ 112). Note that the effects of values over +3 EV or under -3 EV can not be previewed in the monitor.

LV

# The Information Display: Live View Photography

To hide or display indicators in the monitor during live view photography, press the **info** button.

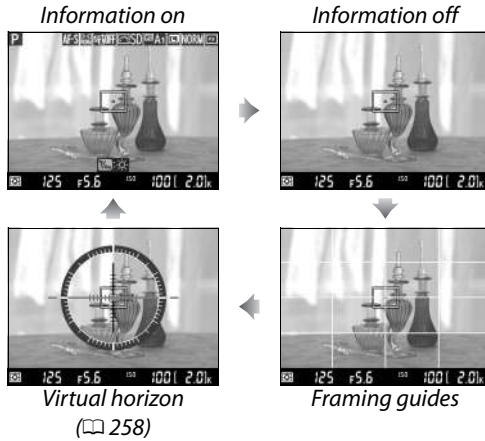

## Manual Focus

To focus in manual focus mode (**103**), rotate the lens focus ring until the subject is in focus.

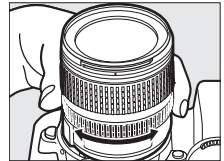

To magnify the view in the monitor up to about 19 × for precise focus, press the **QUAL** button. While the view through the lens is zoomed in, a navigation window will appear in a gray frame at the bottom right corner of the display. Use the multi selector to scroll to areas of the frame not visible in the monitor (available only if wide- or normal-area AF is selected for AF-area mode), or press **ISO** to zoom out.

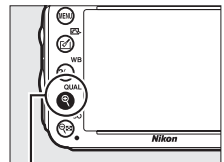

**QUAL** button



Navigation window

### **Non-CPU Lenses**

When using non-CPU lenses, be sure to enter the focal length and maximum aperture using the **Non-CPU lens data** option in the setup menu (☞ 172). Non-CPU lenses can be used only in **A** and **M** modes (☞ 73); aperture can be adjusted using the lens aperture ring.

### **The Count Down Display**

A count down will be displayed 30 s before live view ends automatically (☞ 53; the timer turns red if live view is about to end to protect the internal circuits or, if an option other than **No limit** is selected for Custom Setting c4—**Monitor off delay** > **Live view**; ☞ 228—5 s before the monitor is due to turn off automatically). Depending on shooting conditions, the timer may appear immediately when live view is selected. Note that although the count down does not appear during playback, live view will still end automatically when the timer expires.

### **HDMI**

If the camera is attached to an HDMI video device during live view photography, the camera monitor will remain on and the video device will display the view through the lens as shown at right. If the device supports HDMI-CEC, select **Off** for the **HDMI** > **Device control** option in the setup menu (☞ 205) before shooting in live view.



LV



# Movie Live View

Movies can be recorded in live view.

- 1 Rotate the live view selector to  (movie live view).

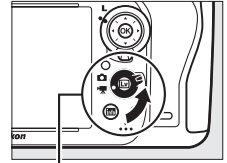

Live view selector

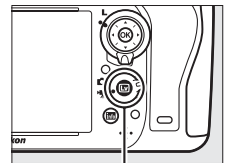

- 2 Press the  button.

The mirror will be raised and the view through the lens will be displayed in the camera monitor as it would appear in the actual movie, modified for the effects of exposure. The subject will no longer be visible in the viewfinder.







 button

## The Icon

A  icon ( 61) indicates that movies can not be recorded.

## Before Recording

Before recording, choose an aperture (modes **A** and **M** only,  77, 78); you can also choose a Picture Control (modes **P**, **S**, **A**, and **M** only,  129) or color space ( 217). In modes **P**, **S**, **A**, and **M**, white balance ( 115) can be set at any time by pressing the  (WB) button and rotating the main command dial.

- 3 Choose a focus mode ( 51).



- 4 Choose an AF-area mode ( 52).



## 5 Focus.

Frame the opening shot and focus as described in Steps 3 and 4 on pages 49 (for more information on focusing in movie live view, see page 51). Note that the number of subjects that can be detected in face-priority AF drops in movie live view.



### Exposure

The following settings can be adjusted in movie live view:

	Aperture	Shutter speed	ISO sensitivity	Exposure compensation
P, S, A	—	—	—	✓
M	—	✓	✓	—
Other shooting modes	—	—	—	—

In mode **M**, ISO sensitivity can be set to values between 100 and Hi 2 and shutter speed to values between  $\frac{1}{25}$  s and  $\frac{1}{4,000}$  s (the slowest available shutter speed varies with the frame rate; 65). In other modes, shutter speed and ISO sensitivity are adjusted automatically. If the result is over- or under-exposed, exit and restart movie live view.

## 6 Start recording.

Press the movie-record button to start recording. A recording indicator and the time available are displayed in the monitor. Exposure is set using matrix metering and can be locked by pressing the **AE-L/AF-L** button ( 110) or (in modes **P**, **S**, and **A**) altered by up to  $\pm 3$  EV in steps of  $\frac{1}{3}$  EV using exposure compensation ( 112). In autofocus mode, focus can be locked by pressing the shutter-release button halfway.

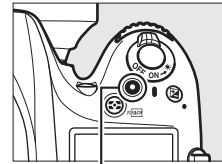

Movie-record button  
Recording indicator



Time remaining

### Audio

The camera can record both video and sound; do not cover the microphone on the front of the camera during movie recording. Note that the built-in microphone may record sounds made by the lens during autofocus or vibration reduction.



## 7 End recording.

Press the movie-record button again to end recording. Recording will end automatically when the maximum length is reached, or the memory card is full.

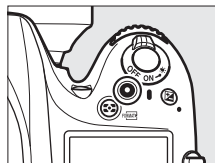

### Maximum Length

The maximum length for individual movie files is 4 GB (for maximum recording times, see page 65); note that depending on memory card write speed, shooting may end before this length is reached (□ 334).

### Taking Photographs

To take a photograph while recording is in progress, press the shutter-release button all the way down (if desired, shooting information display can be assigned to the **Fn**, depth-of-field preview, or **AE-L/AF-L** button and the button used to display camera still photography settings before shooting; □ 247, 248). Movie recording will end (the footage recorded to that point will be saved) and the camera will return to live view. The photograph will be recorded at the current image area setting using a crop with an aspect ratio of 16 : 9. Photos will be taken with the flash off. Note that the exposure for photographs can not be previewed during movie live view; mode **P**, **S**, or **A** is recommended but accurate results can be achieved in mode **M** by using the **Fn**, depth-of-field preview, or **AE-L/AF-L** button (□ 247, 248), using the button to display shooting information and checking the exposure indicator. Exposure compensation for the photograph can be set to values between -5 and +5 EV, but only values between -3 and +3 can be previewed in the monitor (modes **P**, **S**, and **A**; □ 112).

### The Count-Down Display

A count down will be displayed 30 s before live view ends automatically (□ 53). Depending on shooting conditions, the timer may appear immediately when movie recording begins. Note that regardless of the amount of recording time available, live view will still end automatically when the timer expires. Wait for the internal circuits to cool before resuming movie recording.

## 8 Exit live view mode.

Press the  button to exit live view mode.

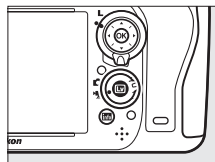

# Indices

If **Index marking** is selected for Custom Setting g1 (**Assign Fn button**, □ 247), g2 (**Assign preview button**, □ 248), or g3 (**Assign AE-L/AF-L button**, □ 248), you can press the button during recording to add indices that can be used to locate frames during editing and playback (□ 68). Up to 20 indices can be added to each movie.



*Index*



## See Also

Frame size, microphone sensitivity, and card slot options are available in the **Movie settings** menu (□ 65). Focus can be adjusted manually as described on page 55. The roles played by the **OK**, **Fn**, depth-of-field preview, and **AE-L/AF-L** buttons can be chosen using Custom Settings f1 (**OK button (shooting mode)**; □ 241), g1 (**Assign Fn button**; □ 247), g2 (**Assign preview button**; □ 248), and g3 (**Assign AE-L/AF-L button**, □ 248), respectively (the last three options also allow you to lock exposure without having to keep a button pressed). Custom Setting g4 (**Assign shutter button**; □ 248) controls whether the shutter-release button can be used to start movie live view or to start and end movie recording.

# The Live View Display: Movie Live View

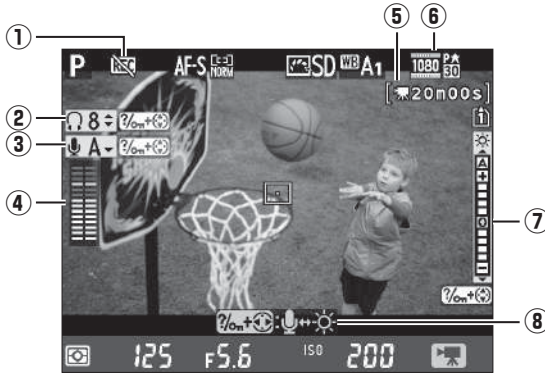

Item	Description	
① "No movie" icon	Indicates that movies can not be recorded.	—
② Headphone volume	Volume of audio output to headphones.	62
③ Microphone sensitivity	Microphone sensitivity for movie recording.	62
④ Sound level	Sound level for audio recording. Displayed in red if level is too high; adjust microphone sensitivity accordingly. Left (L) and right (R) channel indicators appear when optional ME-1 or other stereo microphone is used.	62
⑤ Time remaining (movie live view)	The recording time available for movies.	58
⑥ Movie frame size	The frame size for movie recording.	65
⑦ Monitor brightness indicator	A monitor brightness indicator.	62
⑧ Guide	A guide to the options available during movie live view.	62

## Using an External Microphone

The optional ME-1 stereo microphone can be used to record sound in stereo or to avoid recording lens noise caused by autofocus (□ 298).

## Headphones

Third-party headphones can be used. Note that high sound levels may result in high volume; particular care should be taken when headphones are used.

## ■ ■ Adjusting Settings in the Live View Display

Microphone sensitivity, headphone volume, and monitor brightness can be adjusted as described below. Note that microphone sensitivity and headphone volume can not be adjusted during recording, and that brightness affects the monitor only (□ 61); movies recorded with the camera are unaffected.

### 1 Highlight a setting.

Press and hold **WB** and press ◀ or ▶ to highlight the indicator for the desired setting.

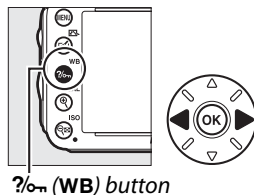

**WB** button

### 2 Adjust the highlighted setting.

Keeping the **WB** button pressed, press ▲ or ▼ to adjust the highlighted setting.



## The Information Display: Movie Live View

To hide or display indicators in the monitor during movie live view, press the **Info** button.

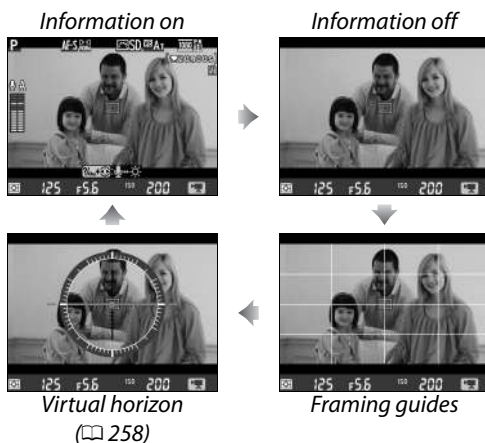

# Image Area

Regardless of the option selected for **Image area** in the shooting menu (☐ 89), all movies and photographs recorded in movie live view (☐ 57) have an aspect ratio of 16 : 9. Images recorded with **On** selected for **Image area** > **Auto DX crop** and a DX lens attached use a DX-based movie format, as do images recorded with **DX (24×16) 1.5×** selected for **Image area** > **Choose image area**. An FX-based movie format is used when **FX (36 × 24) 1.0×** is selected. A  icon is displayed when the DX-based movie format is selected.



## **Movie Live View Photographs**

The following table shows the size of photographs taken in movie live view:

Image area	Option	Size (pixels)	Print size (cm/in.)*
FX-based format (35.5 × 20.0 mm)	Large	6,016 × 3,376	50.9 × 28.6/20.1 × 11.3
	Medium	4,512 × 2,528	38.2 × 21.4/15.0 × 8.4
	Small	3,008 × 1,688	25.5 × 14.3/10.0 × 5.6
DX-based format (23.5 × 13.2 mm)	Large	3,936 × 2,224	33.3 × 18.8/13.1 × 7.4
	Medium	2,944 × 1,664	24.9 × 14.1/ 9.8 × 5.5
	Small	1,968 × 1,112	16.7 × 9.4/ 6.6 × 3.7

\* Approximate size when printed at 300 dpi. Print size in inches equals image size in pixels divided by printer resolution in dots per inch (dpi; 1 inch = approximately 2.54 cm).

Image quality is determined by the option selected for **Image quality** in the shooting menu (☐ 93).

## HDMI

If the camera is connected to an HDMI device (□ 204), the view through the lens will appear both in the camera monitor and on the HDMI device. The indicators that appear in the HDMI device during movie recording are shown at right. The camera monitor does not show the sound level or virtual horizon; indicators in the monitor and on the HDMI device can not be hidden or displayed using the  button. To use live view when the camera is connected to an HDMI-CEC device, select **Off** for **HDMI > Device control** in the setup menu (□ 205).



## Remote Cords

If **Record movies** is selected for Custom Setting g4 (**Assign shutter button**, □ 248), the shutter-release buttons on optional MC-DC2 remote cords (□ 298) can be used to start movie live view and to start and end movie recording.

## Recording Movies

Flicker, banding, or distortion may be visible in the monitor and in the final movie under fluorescent, mercury vapor, or sodium lamps or if the camera is panned horizontally or an object moves at high speed through frame (for information on reducing flicker and banding, see **Flicker reduction**, □ 252). Jagged edges, color fringing, moiré, and bright spots may also appear. Bright bands may appear in some areas of the frame with flashing signs and other intermittent light sources or if the subject is briefly illuminated by a strobe or other bright, momentary light source. When recording movies, avoid pointing the camera at the sun or other strong light sources. Failure to observe this precaution could result in damage to the camera's internal circuitry. Note that noise (randomly-spaced bright pixels, fog, or lines) and unexpected colors may appear if you zoom in on the view through the lens (□ 55) during movie live view.

Flash lighting can not be used during movie live view.

Recording ends automatically if the lens is removed, the mode dial is rotated, or a remote control release mode is selected.

Live view may end automatically to prevent damage to the camera's internal circuits; exit live view when the camera is not in use. Note that the temperature of the camera's internal circuits may rise and noise (bright spots, randomly-spaced bright pixels, or fog) may be displayed in the following instances (the camera may also become noticeably warm, but this does not indicate a malfunction):















- The ambient temperature is high
- The camera has been used for extended periods in live view or to record movies
- The camera has been used in continuous release mode for extended periods

If live view does not start when you press the  button, wait for the internal circuits to cool and then try again.

# Movie Settings

Use the **Movie settings** option in the shooting menu to adjust the following settings.

- **Frame size/frame rate, Movie quality:** Choose from the following options:

	Frame size/frame rate		Movie quality	Maximum length (★ high quality/Normal)
	Frame size (pixels)	Frame rate *	Maximum bit rate (Mbps) (★ high quality/Normal)	
 	1920 × 1080	30p	24/12	20 min./ 29 min. 59 s
 	1920 × 1080	25p		
 	1920 × 1080	24p		
 	1280 × 720	60p		
 	1280 × 720	50p		
 	1280 × 720	30p	12/ 8	29 min. 59 s/ 29 min. 59 s
 	1280 × 720	25p		

\* Listed value. Actual frame rates for 60p, 50p, 30p, 25p, and 24p are 59.94, 50, 29.97, 25, and 23.976 fps respectively.

- **Microphone:** Turn the built-in or optional ME-1 stereo microphones on or off or adjust microphone sensitivity. Choose **Auto sensitivity** to adjust sensitivity automatically, **Microphone off** to turn sound recording off; to select microphone sensitivity manually, select **Manual sensitivity** and choose a sensitivity.
- **Destination:** Choose the slot to which movies are recorded. The menu shows the time available on each card; recording ends automatically when no time remains.



## 1 Select **Movie settings**.

Press the **MENU** button to display the menus. Highlight **Movie settings** in the shooting menu and press ►.

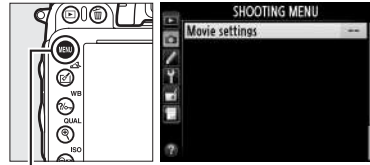

**MENU** button

## 2 Choose movie options.

Highlight the desired item and press ►, then highlight an option and press **OK**.

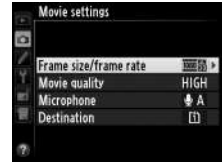

### **Frame Size and Rate**

Frame size and rate affects the distribution and amount of noise (randomly-spaced bright pixels, fog, or bright spots).







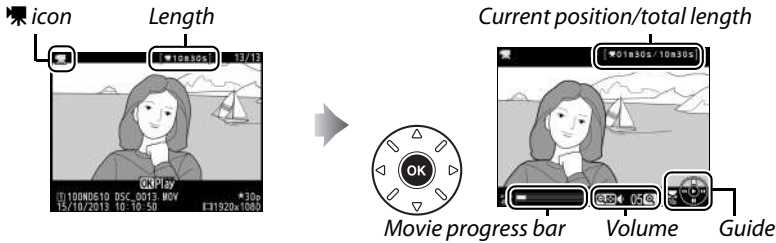



# Viewing Movies

Movies are indicated by a  icon in full-frame playback (177). Press **OK** to start playback.



The following operations can be performed:

To	Use	Description
Pause		Pause playback.
Play	<b>OK</b>	Resume playback when movie is paused or during rewind/advance.
Rewind/advance		Speed increases with each press, from 2x to 4x to 8x to 16x; keep pressed to skip to beginning or end of movie (first frame is indicated by  in top right corner of monitor, last frame by  ). If playback is paused, movie rewinds or advances one frame at a time; keep pressed for continuous rewind or advance.
Skip 10 s		Rotate the main command dial to skip ahead or back 10 s.
Skip ahead/back		Use sub-command dial to skip to next or previous index, or to skip to the last or first frame if the movie contains no indices.
Adjust volume	<b>QUAL</b> / <b>ISO</b>	Press <b>QUAL</b> to increase volume, <b>ISO</b> to decrease.
Trim movie		See page 69 for more information.
Exit		Exit to full-frame playback.
Return to shooting mode		Press the shutter-release button halfway to exit to shooting mode.



### The Icon

Movies with indices (📄 60) are indicated by a  icon in full-frame playback.





### The Icon

 is displayed in full-frame and movie playback if the movie was recorded without sound.



# Editing Movies



Trim footage to create edited copies of movies or save selected frames as JPEG stills.

Option	Description
 <b>Choose start/end point</b>	Create a copy from which the opening or closing footage has been removed.
 <b>Save selected frame</b>	Save a selected frame as a JPEG still.

## Trimming Movies

To create trimmed copies of movies:





### 1 Display a movie full frame.

Press the  button to display pictures full frame in the monitor and press  and  to scroll through pictures until the movie you wish to edit is displayed.



 button



### 2 Choose a starting or end point.

Play the movie back as described on page 67, pressing  to start and resume playback and  to pause and pressing  or  or rotating the main or sub-command dials to locate the desired frame ( 67). Your approximate position in the movie can be ascertained from the movie progress bar.





Movie progress bar

### 3 Display movie edit options.

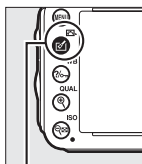
Press the  () button to display movie edit options.



 () button

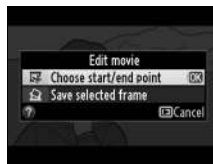

---

## 4 Select Choose start/end point.

Highlight **Choose start/end point** and press **OK**.

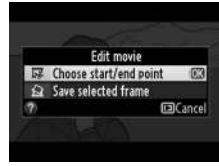

The dialog shown at right will be displayed; choose whether the current frame will be the starting or end point of the copy and press **OK**.

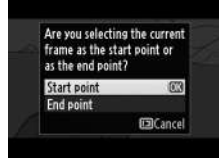

---

## 5 Delete frames.

If the desired frame is not currently displayed, press **◀** or **▶** to advance or rewind (to skip to 10 s ahead or back, rotate the main command dial; to skip to an index, or to the first or last frame if the movie contains no indices, rotate the sub-command dial). To switch the current selection from start point (**↶**) to end point (**↷**) or vice versa, press **?/WB**.

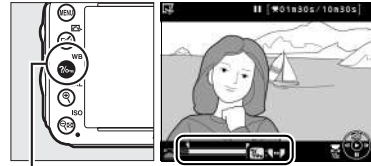

**?/WB** (**WB**) button

Once you have selected the start point and/or end point, press **▲**. All frames before the selected start point and after the selected end point will be removed from the copy.





---

## 6 Save the copy.

Highlight one of the following and press **OK**:

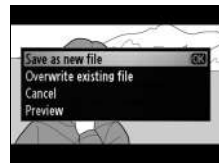
- **Save as new file:** Save the copy to a new file.
- **Overwrite existing file:** Replace the original movie file with the edited copy.
- **Cancel:** Return to Step 5.
- **Preview:** Preview the copy.



Edited copies are indicated by a  icon in full-frame playback.

## **Trimming Movies**

Movies must be at least two seconds long. If a copy can not be created at the current playback position, the current position will be displayed in red in Step 5 and no copy will be created. The copy will not be saved if there is insufficient space available on the memory card.

Copies have the same time and date of creation as the original.

## **The Retouch Menu**

Movies can also be edited using the **Edit movie** option in the retouch menu (☞ 261).



# Saving Selected Frames

To save a copy of a selected frame as a JPEG still:

- 1 View the movie and choose a frame.**

Play the movie back as described on page 67; your approximate position in the movie can be ascertained from the movie progress bar. Press ◀ or ▶ to rewind or advance and press ▼ to pause the movie at the frame you intend to copy.



- 2 Display movie edit options.**

Press the  (F3) button to display movie edit options.

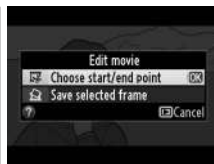
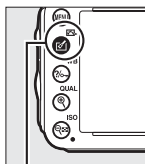

 (F3) button

- 3 Choose Save selected frame.**

Highlight **Save selected frame** and press .

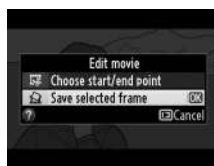



- 4 Create a still copy.**

Press ▲ to create a still copy of the current frame.



- 5 Save the copy.**

Highlight **Yes** and press  to create a fine-quality (93) JPEG copy of the selected frame. Movie stills are indicated by a  icon in full-frame playback.



## Save Selected Frame

JPEG movie stills created with the **Save selected frame** option can not be retouched. JPEG movie stills lack some categories of photo information (179).

# P, S, A, and M Modes

**P, S, A,** and **M** modes offer different degrees of control over shutter speed and aperture.



## Lens Types

When using a CPU lens equipped with an aperture ring (☐ 287), lock the aperture ring at the minimum aperture (highest f-number). Type G and E lenses are not equipped with an aperture ring.

Non-CPU lenses can only be used in modes **A** (aperture-priority auto) and **M** (manual), when aperture can only be adjusted using the lens aperture ring. Selecting any other mode disables the shutter release.

## Non-CPU Lenses (☐ 285)

Use the lens aperture ring to adjust aperture. If the maximum aperture of the lens has been specified using the **Non-CPU lens data** item in setup menu (☐ 172) when a non-CPU lens is attached, the current f-number will be displayed in the viewfinder and control panel, rounded to the nearest full stop. Otherwise the aperture displays will show only the number of stops ( $\Delta F$ , with maximum aperture displayed as  $\Delta F0$ ) and the f-number must be read from the lens aperture ring.

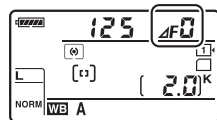

## Shutter Speed and Aperture

Two of the chief factors in determining exposure are shutter speed and aperture. By slowing shutter speed while increasing aperture, or increasing shutter speed while reducing aperture, you can achieve different effects while keeping exposure constant. Fast shutter speeds and large apertures freeze moving objects and soften background details, while slow shutter speeds and small apertures blur moving objects and bring out background details.

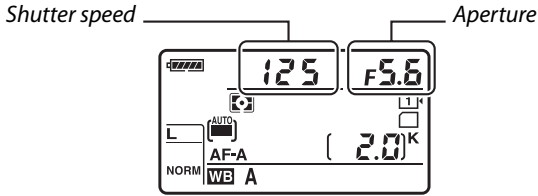

*Fast shutter speed*  
( $1/1,600$  s)



*Slow shutter speed*  
( $1/6$  s)



*Large aperture (f/5.6)*



*Small aperture (f/22)*

*(Remember, the higher the f-number, the smaller the aperture.)*



## P: Programmed Auto

In this mode, the camera automatically adjusts shutter speed and aperture according to a built-in program to ensure optimal exposure in most situations. This mode is recommended for snapshots and other situations in which you want to leave the camera in charge of shutter speed and aperture.



### **Flexible Program**

In mode **P**, different combinations of shutter speed and aperture can be selected by rotating the main command dial while the exposure meters are on (“flexible program”). Rotate the dial to the right for large apertures (low f-numbers) that blur background details or fast shutter speeds that “freeze” motion. Rotate the dial to the left for small apertures (high

f-numbers) that increase depth of field or slow shutter speeds that blur motion. All combinations produce the same exposure. While flexible program is in effect, a  indicator appears in the control panel. To restore default shutter speed and aperture settings, rotate the main command dial until the indicator is no longer displayed, choose another mode, or turn the camera off.

### **See Also**

See page 315 for information on the built-in exposure program. For information on activating the exposure meters, see “The Standby Timer” on page 39.



*Main command dial*

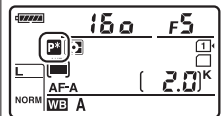

## S: Shutter-Priority Auto

In shutter-priority auto, you choose the shutter speed while the camera automatically selects the aperture that will produce the optimal exposure. Use slow shutter speeds to suggest motion by blurring moving subjects, fast shutter speeds to “freeze” motion.



Fast shutter speed ( $1/1,600$  s)



Slow shutter speed ( $1/6$  s)

To choose a shutter speed, rotate the main command dial while the exposure meters are on. Shutter speed can be set to “x 200” or to values between 30 s and  $1/4,000$  s.

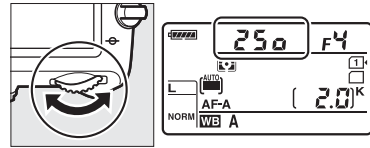

Main command dial

### See Also

See page 323 for information on what to do if flashing “b u t b” or “- -” indicator appears in the shutter-speed displays.

## A: Aperture-Priority Auto

In aperture-priority auto, you choose the aperture while the camera automatically selects the shutter speed that will produce the optimal exposure. Large apertures (low f-numbers) increase flash range (☐ 147) and reduce depth of field, blurring objects behind and in front of the main subject. Small apertures (high f-numbers) increase depth of field, bringing out details in the background and foreground. Short field depths are generally used in portraits to blur background details, long field depths in landscape photographs to bring the foreground and background into focus.



Large aperture (f/5.6)



Small aperture (f/22)

To choose an aperture between the minimum and maximum values for the lens, rotate the sub-command dial while the exposure meters are on.

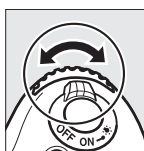

Sub-command dial

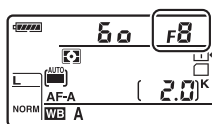

### Depth-of-Field Preview

To preview the effects of aperture, press and hold the depth-of-field preview button. The lens will be stopped down to the aperture value selected by the camera (modes **P** and **S**) or the value chosen by the user (modes **A** and **M**), allowing depth of field to be previewed in the viewfinder.

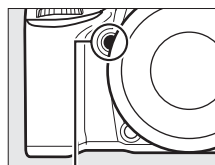

Depth-of-field preview button

### Custom Setting e5—Modeling Flash

This setting controls whether the built-in flash and optional flash units such as the SB-910, SB-900, SB-800, SB-700, and SB-600 (☐ 293) will emit a modeling flash when the depth-of-field preview button is pressed. See page 241 for more information.

## M: Manual

In manual exposure mode, you control both shutter speed and aperture. While the exposure meters are on, rotate the main command dial to choose a shutter speed, and the sub-command dial to set aperture. Shutter speed can be set to “x 200” or to values between 30 s and 1/4,000 s, or the shutter can be held open indefinitely for a long time-exposure (bulb, □ 79). Aperture can be set to values between the minimum and maximum values for the lens. Use the exposure indicators to check exposure.

Shutter speed

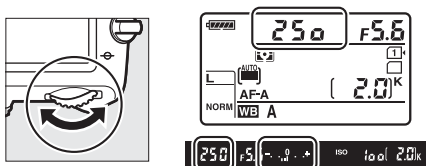

Main command dial

Aperture

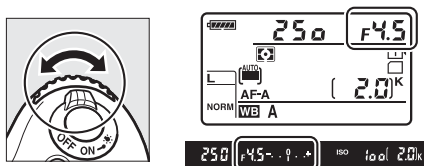

Sub-command dial

### ✍ AF Micro NIKKOR Lenses

Provided that an external exposure meter is used, the exposure ratio need only be taken into account when the lens aperture ring is used to set aperture.

### ✍ The Exposure Indicator

If a shutter speed other than “bulb” or “time” is selected, the exposure indicator in the viewfinder shows whether the photograph would be under- or over-exposed at current settings. Depending on the option chosen for Custom Setting b2 (**EV steps for exposure cntrl**, □ 224), the amount of under- or over-exposure is shown in increments of 1/3 EV or 1/2 EV (the illustrations below show the display in the viewfinder when **1/3 step** is selected for Custom Setting b2). If the limits of the exposure metering system are exceeded, the display will flash.

Optimal exposure	Underexposed by 1/3 EV	Overexposed by over 2 EV
- . . 0 . . +	- . . 0 . . +	- . . 0 . . . . . +

### ✍ See Also

For information reversing the exposure indicators so that negative values are displayed on the right and positive values on the left, see Custom Setting f8 (**Reverse indicators**, □ 246).

## ■ ■ Long Time-Exposures (M Mode Only)

Select the following shutter speeds for long time-exposures of moving lights, the stars, night scenery, or fireworks.

- **Bulb (b, L, B):** The shutter remains open while the shutter-release button is held down. To prevent blur, use a tripod or an optional MC-DC2 remote cord (□ 298).
- **Time (- -):** Requires an optional ML-L3 remote control (□ 298). Start the exposure by pressing the ML-L3 shutter-release button. The shutter remains open for thirty minutes or until the button is pressed a second time.



Length of exposure: 35 s  
Aperture: f/25

### 1 Ready the camera.

Mount the camera on a tripod or place it on a stable, level surface. To prevent light entering via the viewfinder interfering with exposure, remove the rubber eyecup and cover the viewfinder with the supplied DK-5 eyepiece cap (□ 86). To prevent loss of power before the exposure is complete, use a fully charged EN-EL15 battery or an optional EH-5b AC adapter and EP-5B power connector. Note that noise (bright spots, randomly-spaced bright pixels, or fog) may be present in long exposures; before shooting, choose **On** for **Long exposure NR** in the shooting menu (□ 218).

PS  
AM

### 2 Rotate the mode dial to M.

Mode dial

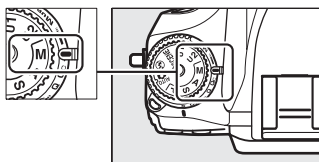

---

### 3 Choose a shutter speed.

While the exposure meters are on, rotate the main command dial to choose a shutter speed of **bulb**.

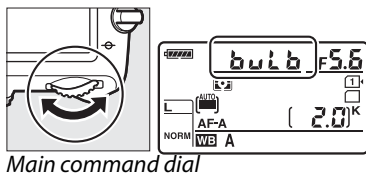

Main command dial

For a shutter speed of “time” (- -), select remote control release mode (☐ 85) after choosing the shutter speed.

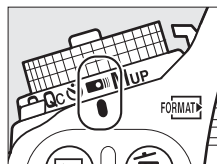

---

### 4 Open the shutter.

**Bulb:** After focusing, press the shutter-release button on the camera or optional remote cord all the way down. Keep the shutter-release button pressed until the exposure is complete.

**Time:** Press the ML-L3 shutter-release button all the way down.

---

### 5 Close the shutter.

**Bulb:** Take your finger off the shutter-release button.

**Time:** Press the ML-L3 shutter-release button all the way down. Shooting ends automatically after thirty minutes.



# User Settings: U1 and U2 Modes

Assign frequently-used settings to the **U1** and **U2** positions on the mode dial.

## Saving User Settings

### 1 Select a mode.

Rotate the mode dial to the desired mode.

Mode dial

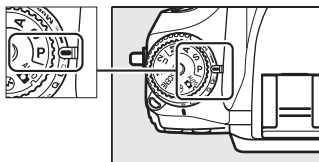

### 2 Adjust settings.

Make the desired adjustments to flexible program (mode **P**), shutter speed (modes **S** and **M**), aperture (modes **A** and **M**), exposure and flash compensation, flash mode, focus point, metering, autofocus and AF-area modes, bracketing, and settings in the shooting (📖 214) and Custom Settings (📖 219) menus (note that the camera will not store the options selected for **Storage folder**, **File naming**, **Image area**, **Manage Picture Control**, **Multiple exposure**, or **Interval timer shooting**).

### 3 Select Save user settings.

Press the **MENU** button to display the menus. Highlight **Save user settings** in the setup menu and press **▶**.

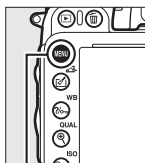

MENU button



### 4 Select Save to U1 or Save to U2.

Highlight **Save to U1** or **Save to U2** and press **▶**.

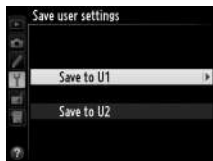

## 5 Save user settings.

Highlight **Save settings** and press **OK** to assign the settings selected in Steps 1 and 2 to the mode dial position selected in Step 4.

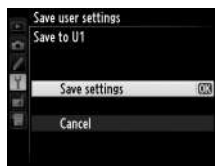

## Recalling User Settings

Simply rotate the mode dial to **U1** to recall the settings assigned to **Save to U1**, or to **U2** to recall the settings assigned to **Save to U2**.

Mode dial

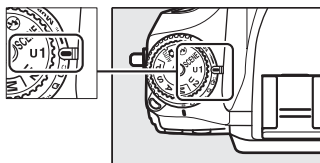

## Resetting User Settings

To reset settings for **U1** or **U2** to default values:

### 1 Select Reset user settings.

Press the **MENU** button to display the menus. Highlight **Reset user settings** in the setup menu and press **▶**.

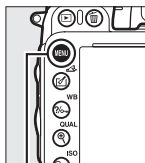

MENU button



### 2 Select Reset U1 or Reset U2.

Highlight **Reset U1** or **Reset U2** and press **▶**.

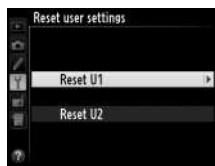

### 3 Reset user settings.

Highlight **Reset** and press **OK**.

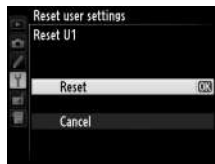





# Release Mode

## Choosing a Release Mode

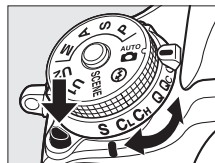
To choose a release mode, press the release mode dial lock release and turn the release mode dial to the desired setting.



Mode	Description
<b>S</b>	<b>Single frame:</b> Camera takes one photograph each time shutter-release button is pressed.
<b>CL</b>	<b>Continuous low speed:</b> While shutter-release button is held down, camera records 1–5 frames per second. <sup>1</sup> Frame rate can be chosen using Custom Setting d5 ( <b>CL mode shooting speed</b> , □ 229). Note that only one picture will be taken if the flash fires.
<b>CH</b>	<b>Continuous high speed:</b> While shutter-release button is held down, camera records up to 6 frames per second. <sup>2</sup> Note that only one picture will be taken if the flash fires.
<b>Q</b>	<b>Quiet shutter-release:</b> As for single frame, except that mirror does not click back into place while shutter-release button is fully pressed, allowing user to control timing of click made by mirror, which is also quieter than in single frame mode. In addition, beep does not sound regardless of setting selected for Custom Setting d1 ( <b>Beep</b> ; □ 228).
<b>Qc</b>	<b>Qc (quiet continuous) shutter-release:</b> While shutter-release button is held down, camera records up to 3 frames per second. <sup>2</sup> Camera noise is reduced.
	<b>Self-timer:</b> Use self-timer for self-portraits or to reduce blurring caused by camera shake (□ 85).
	<b>Remote control:</b> Shutter is controlled using shutter-release button on optional ML-L3 remote control (□ 85).
<b>MUP</b>	<b>Mirror up:</b> Choose this mode to minimize camera shake in telephoto or close-up photography or in other situations in which the slightest camera movement can result in blurred photographs.

- 1 Average frame rate with an EN-EL15 battery, continuous-servo AF, manual or shutter-priority auto exposure, a shutter speed of  $1/200$  s or faster, remaining settings other than Custom Setting d5 at default values, and memory remaining in memory buffer.
- 2 Average frame rate with an EN-EL15 battery, continuous-servo AF, manual or shutter-priority auto exposure, a shutter speed of  $1/200$  s or faster, other settings at default values, and memory remaining in memory buffer.

Frame rate drops at slow shutter speeds or very small apertures (high f-numbers), when vibration reduction (available with VR lenses) or auto ISO sensitivity control is on (□ 105, 107), or when the battery is low.

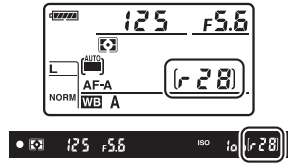

## The Memory Buffer

The camera is equipped with a memory buffer for temporary storage, allowing shooting to continue while photographs are being saved to the memory card. Up to 100 photographs can be taken in succession; note, however, that the frame rate will drop when the buffer is full (∞00). The approximate number of images that can be stored in the buffer at current settings is shown in the exposure-count displays in the viewfinder and control panel while the shutter-release button is pressed. The illustration at right shows the display when space remains in the buffer for about 28 pictures.



While photographs are being recorded to the memory card, the access lamp next to the memory card slot will light. Depending on shooting conditions and memory card performance, recording may take from a few seconds to a few minutes. *Do not remove the memory card or remove or disconnect the power source until the access lamp has gone out.* If the camera is switched off while data remain in the buffer, the power will not turn off until all images in the buffer have been recorded. If the battery is exhausted while images remain in the buffer, the shutter release will be disabled and the images transferred to the memory card.

## Live View

If a continuous release mode is used during live view photography ( 49) or in movie live view ( 57), photographs will be displayed in place of the view through the lens while the shutter-release button is pressed.

## See Also

For information on choosing the maximum number of photographs that can be taken in a single burst, see Custom Setting d6 (**Max. continuous release**,  230). For information on the number of pictures that can be taken in a single burst, see page 335.

# Self-Timer and Remote Control Modes

The self-timer and optional ML-L3 remote control (📖 298) can be used to reduce camera shake or for self-portraits.

## 1 Mount the camera on a tripod.

Mount the camera on a tripod or place the camera on a stable, level surface.

## 2 Select a release mode.

Press the release mode dial lock release and rotate the release-mode dial to ☺ (self-timer) or 📡 (remote control) mode.

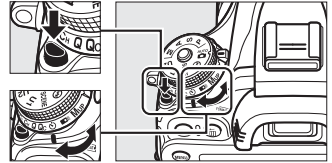

Release mode dial

In remote control mode, the timing of the shutter release can be selected using the **Remote control mode** option in the shooting menu. After pressing the MENU button to display the menus, highlight **Remote control mode** in the shooting menu and press ► to display the following options. Press the selector up or down to highlight an option and press Ⓞ.



MENU button

Option	Description
🕒 2s <b>Delayed remote</b>	Shutter is released 2 s after ML-L3 shutter-release button is pressed.
🕒 <b>Quick-response remote</b>	Shutter is released when ML-L3 shutter-release button is pressed.
🕒 Mup <b>Remote mirror-up</b>	Press ML-L3 shutter-release button once to raise mirror, again to release shutter and take photograph. Prevents blur caused by camera moving when mirror is raised.



### 3 Frame the photograph.

#### **Cover the Viewfinder**

When taking photos without your eye to the viewfinder, remove the DK-21 rubber eyecup (①) and insert the supplied DK-5 eyepiece cap as shown (②). This prevents light entering via the viewfinder interfering with exposure. Hold the camera firmly when removing the rubber eyecup.

DK-21 rubber eyecup

DK-5 eyepiece cap

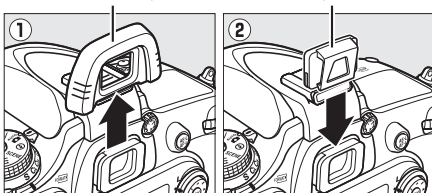

### 4 Take the photograph.

**Self-timer mode:** Press the shutter-release button halfway to focus, and then press the button the rest of the way down to start the self-timer (note that the timer will not start if the camera is unable to focus or in other situations in which the shutter can not be released). The self-timer lamp will start to flash. Two seconds before the photograph is taken, the self-timer lamp will stop flashing. The shutter will be released ten seconds after the timer starts.



**Remote control mode:** From a distance of 5 m (16 ft) or less, aim the transmitter on the ML-L3 at either of the infrared receivers on the camera (□ 2, 4) and press the ML-L3 shutter-release button. *In delayed remote mode*, the self-timer lamp will light for about two seconds before the shutter is released. *In quick-response remote mode*, the self-timer lamp will flash after the shutter has been released. *In remote mirror-up mode*, pressing the ML-L3 shutter-release button once raises the mirror; the shutter will be released and the self-timer lamp will flash after 30 s or when the button is pressed a second time. Note that the remote control can not be used to record movies; even if **Record movies** is selected for Custom Setting g4 (**Assign shutter button**, □ 248), pressing the shutter-release button on the remote control will release the shutter and record a photograph.

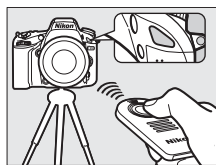



To cancel shooting, select another release mode.

### ✔ Before Using the Remote Control

Before using the remote control for the first time, remove the clear plastic battery-insulator sheet.

### ✔ Using the Built-in Flash

Before taking a photograph with the flash in **P**, **S**, **A**, **M**, or **11** modes, press the  button to raise the flash and wait for the  indicator to be displayed in the viewfinder (□ 143). Shooting will be interrupted if the flash is raised while remote control mode is in effect or after the self-timer has started. If the flash is required, the camera will only respond to the ML-L3 shutter-release button once the flash has charged. In auto or scene modes in which the flash pops up automatically, the flash will begin charging when remote control mode is selected; once the flash is charged, it will automatically pop up and fire when required. Note that only one photograph will be taken when the flash fires, regardless of the number of exposures selected for Custom Setting c3 (**Self-timer**; □ 227).

In flash modes that support red-eye reduction, the red-eye reduction lamp will light for about one second before the shutter is released. In delayed remote mode, the self-timer lamp will light for two seconds, followed by the red-eye reduction lamp which light for one second before the shutter is released.



### ✎ Focusing in Remote Control Mode

The camera will not adjust focus in remote mirror-up mode or when continuous-servo autofocus is selected; note however that if any autofocus mode is selected, you can focus by pressing the camera shutter-release button halfway before shooting (pressing the button all the way down will not release the shutter). If auto- or single-servo autofocus is selected or the camera is in live view in delayed or quick-response remote mode, the camera will automatically adjust focus before shooting; if the camera is unable to focus in viewfinder photography, it will return to stand-by without releasing the shutter.

### ✎ Remote Mirror-up Mode

Metering is not performed in remote mirror-up mode. Photos can not be framed in the viewfinder while the mirror is raised.

### ✎ **b** **1** **5**

Time (bulb) exposures can not be recorded using the self-timer. A fixed shutter speed will be used if a speed of  **b**  **1**  **5** is selected in mode **M**.

### ✎ See Also

For information on choosing the duration of the self-timer, the number of shots taken, and the interval between shots, see Custom Setting c3 (**Self-timer**; □ 227). For information on choosing the length of time the camera will remain in stand-by mode waiting for a signal from the remote control, see Custom Setting c5 (**Remote on duration**; □ 228). For information on controlling the beeps that sound when the self-timer and remote control are used, see Custom Setting d1 (**Beep**; □ 228).



# Mirror up Mode

Choose this mode to minimize blurring caused by camera movement when the mirror is raised. Use of a tripod is recommended.

## 1 Select mirror up mode.

Press the release mode dial lock release and rotate the release mode dial to **MUP**.

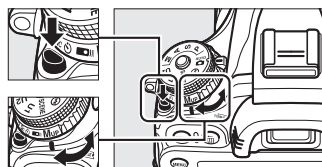

Release mode dial

## 2 Raise the mirror.

Frame the picture, focus, and then press the shutter-release button the rest of the way down to raise the mirror.



### Mirror Up

While the mirror is raised, photos can not be framed in the viewfinder and autofocus and metering will not be performed.

## 3 Take a picture.

Press the shutter-release button all the way down again to take a picture. To prevent blurring caused by camera movement, press the shutter-release button smoothly, or use an optional remote cord (📖 298). The mirror lowers when shooting ends.



### Mirror up Mode

A picture will be taken automatically if no operations are performed for about 30 s after the mirror is raised.

### See Also

For information on using the optional ML-L3 remote control for mirror-up photography, see page 85.



# Image Recording Options

## Image Area

Choose the aspect ratio and angle of view (image area). Thanks to the camera's FX format (35.9 × 24 mm) image sensor, you can choose from angles of view as wide as those supported by 35 mm (135) format film cameras, while automatically cropping pictures to the DX angle of view when using DX format lenses. See page 335 for information on the number of pictures that can be stored at different image area settings.

### ■ Auto DX Crop

Choose whether to automatically select a DX crop when a DX lens is attached.

Option	Description
<b>On</b>	Camera automatically selects DX crop when DX lens is attached. If another lens is attached, the crop selected for <b>Choose image area</b> will be used.
<b>Off</b>	Crop selected for <b>Choose image area</b> is used.

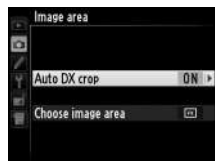

### 🔍 DX Lenses

DX lenses are designed for use with DX format cameras and have a smaller angle of view than lenses for 35mm format cameras. If **Auto DX crop** is off and **FX (36×24) 1.0×** (FX format) is selected for **Choose image area** when a DX lens is attached, the edges of the image may be eclipsed. This may not be apparent in the viewfinder, but when the images are played back you may notice a drop in resolution or that the edges of the picture are blacked out.



## ■ Choose Image Area

Choose the image area used when a non-DX lens is attached or a DX-lens is attached with **Off** selected for **Auto DX crop** (☐ 91).

Option	Description
<b>FX (36×24)</b> 1.0× <b>(FX format)</b>	Images are recorded in FX format using the full area of the image sensor (35.9 × 24.0 mm), producing an angle of view equivalent to a NIKKOR lens on a 35 mm format camera.
<b>DX (24×16)</b> 1.5× <b>(DX format)</b>	An area at the center of the image sensor 23.5 × 15.7 mm is used to record pictures in DX format. To calculate the approximate focal length of the lens in 35mm format, multiply by 1.5.

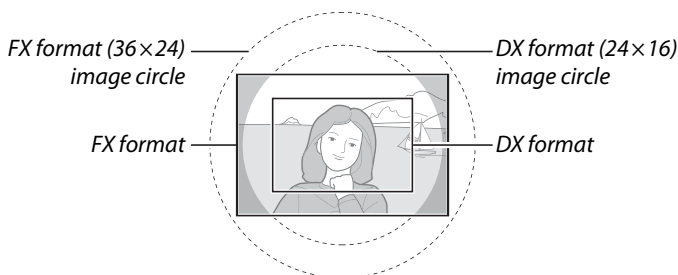

### ✔ Image Area

The selected option is shown in the information display.

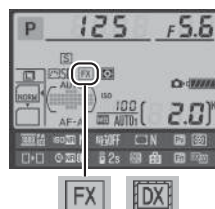

### ✔ The Viewfinder Display

The DX format crop is shown at right; the area outside the crop can be viewed in gray when **Off** is selected for Custom Setting a4 (**AF point illumination**, ☐ 222).

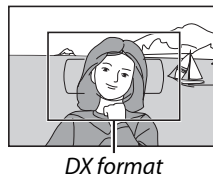

### ✔ See Also

See page 63 for information on the crops available in movie live view.

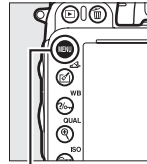

Image area can be set using the **Image area** option in the shooting menu or by pressing a control and rotating a command dial.

## ■ The Image Area Menu

### 1 Select Image area in the shooting menu.

Press MENU to display the menus. Highlight **Image area** in the shooting menu (☞ 214) and press ►.



MENU button



### 2 Choose an option.

Highlight **Auto DX crop** or **Choose image area** and press ►.



### 3 Adjust settings.

Choose an option and press OK. The selected crop is displayed in the viewfinder (☞ 90).



### 1 Assign image area selection to a camera control.

Select **Choose image area** for a camera control in the Custom Settings menu (☞ 219). Image area selection can be assigned to the **Fn** button (Custom Setting f2, **Assign Fn button**, ☞ 242) or the depth-of-field preview button (Custom Setting f3, **Assign preview button**, ☞ 244).

### 2 Use the selected control to choose an image area.

The image area can be selected by pressing the selected button and rotating the main or sub-command dial until the desired crop is displayed in the viewfinder (☞ 90).

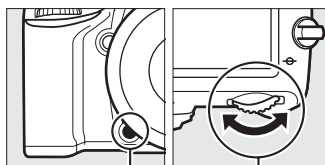

*Fn button*    *Main command dial*

The option currently selected for image area can be viewed by pressing the button to display the image area in the control panel, viewfinder, or information display. FX format is displayed as "36 – 24" and DX format as "24 – 16".

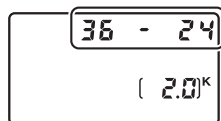

#### **Auto DX Crop**

The selected control can not be used to select image area when a DX lens is attached and **Auto DX crop** is on.

#### **Image Size**

Image size varies with the option selected for image area (☞ 95).

# Image Quality and Size

Together, image quality and size determine how much space each photograph occupies on the memory card. Larger, higher quality images can be printed at larger sizes but also require more memory, meaning that fewer such images can be stored on the memory card (☞ 335).

## Image Quality

Choose a file format and compression ratio (image quality).

Option	File type	Description
NEF (RAW)	NEF	Raw data from the image sensor are saved directly to the memory card. Settings such as white balance and contrast can be adjusted after shooting.
JPEG fine	JPEG	Record JPEG images at a compression ratio of roughly 1:4 (fine quality).*
JPEG normal		Record JPEG images at a compression ratio of roughly 1:8 (normal quality).*
JPEG basic		Record JPEG images at a compression ratio of roughly 1:16 (basic quality).*
NEF (RAW)+ JPEG fine	NEF/ JPEG	Two images are recorded, one NEF (RAW) image and one fine-quality JPEG image.
NEF (RAW)+ JPEG normal		Two images are recorded, one NEF (RAW) image and one normal-quality JPEG image.
NEF (RAW)+ JPEG basic		Two images are recorded, one NEF (RAW) image and one basic-quality JPEG image.

\* **Size priority** selected for **JPEG compression**.

Image quality can be set by pressing the  (**QUAL**) button and rotating the main command dial until the desired setting is displayed in the control panel.

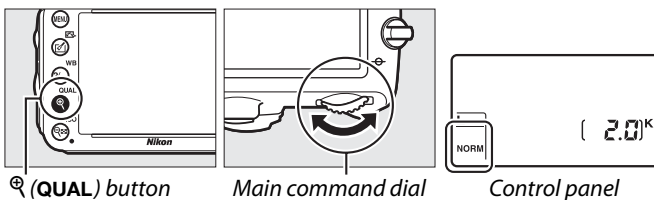

### The Shooting Menu

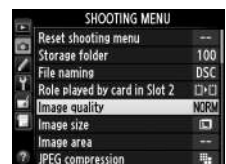

Image quality can also be adjusted using the **Image quality** option in the shooting menu (☞ 214).



The following options can be accessed from the shooting menu. Press the **MENU** button to display the menus, highlight the desired option and press **▶**.



### ■■ JPEG Compression

Choose the type of compression for JPEG images.

Option	Description
 <b>Size priority</b>	Images are compressed to produce relatively uniform file size.
 <b>Optimal quality</b>	Optimal image quality. File size varies with scene recorded.

### ■■ NEF (RAW) Recording > Type

Choose the type of compression for NEF (RAW) images.



Option	Description
ON  <b>Lossless compressed</b>	NEF images are compressed using a reversible algorithm, reducing file size by about 20–40% with no effect on image quality.
ON  <b>Compressed</b>	NEF images are compressed using a non-reversible algorithm, reducing file size by about 35–55% with almost no effect on image quality.

### ■■ NEF (RAW) Recording > NEF (RAW) Bit Depth

Choose a bit depth for NEF (RAW) images.

Option	Description
12-bit <b>12-bit</b>	NEF (RAW) images are recorded at a bit-depth of 12 bits.
14-bit <b>14-bit</b>	NEF (RAW) images are recorded at a bit depth of 14 bits, producing files larger than those with a bit depth of 12 bits but increasing the color data recorded.

#### **NEF (RAW) Images**

NEF (RAW) images can be viewed on the camera or using software such as Capture NX 2 (available separately;  298) or ViewNX 2 (available on the supplied ViewNX 2 CD). Note that the option selected for image size does not affect the size of NEF (RAW) images; when viewed on a computer, NEF (RAW) images have the dimensions given for large (-size) images in the table on page 95. JPEG copies of NEF (RAW) images can be created using the **NEF (RAW) processing** option in the retouch menu ( 271).

#### **NEF+JPEG**

When photographs taken at settings of NEF (RAW) + JPEG are viewed on the camera with only one memory card inserted, only the JPEG image will be displayed. If both copies are recorded to the same memory card, both copies will be erased when the photo is deleted. If the JPEG copy is recorded to a separate memory card using the **Role played by card in Slot 2 > RAW Slot 1—JPEG Slot 2** option, deleting the JPEG copy will not delete the NEF (RAW) image.

# Image Size





Image size is measured in pixels. Choose from  Large,  Medium, or  Small (note that image size varies depending on the option selected for **Image area**,  89):

Image area	Option	Size (pixels)	Print size (cm/in.)*
FX (36×24) 1.0× (FX format)	Large	6,016 × 4,016	50.9 × 34.0/20.1 × 13.4
	Medium	4,512 × 3,008	38.2 × 25.5/15.0 × 10.0
	Small	3,008 × 2,008	25.5 × 17.0/10.0 × 6.7
DX (24×16) 1.5× (DX format)	Large	3,936 × 2,624	33.3 × 22.2/13.1 × 8.7
	Medium	2,944 × 1,968	24.9 × 16.7/ 9.8 × 6.6
	Small	1,968 × 1,312	16.7 × 11.1/ 6.6 × 4.4

\* Approximate size when printed at 300 dpi. Print size in inches equals image size in pixels divided by printer resolution in dots per inch (dpi; 1 inch=approximately 2.54 cm).

Image size can be set by pressing the  (**QUAL**) button and rotating the sub-command dial until the desired setting is displayed in the control panel.

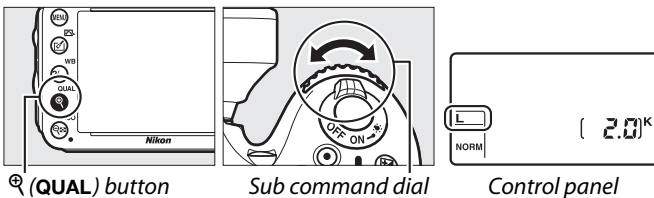

## The Shooting Menu

Image size can also be adjusted using the **Image size** option in the shooting menu ( 214).



# Using Two Memory Cards

When two memory cards are inserted in the camera, you can use the **Role played by card in Slot 2** item in the shooting menu to choose the role played by the card in Slot 2. Choose from **Overflow** (the card in Slot 2 is used only when the card in Slot 1 is full), **Backup** (each picture is recorded twice, once to the card in Slot 1 and again to the card in Slot 2), and **RAW Slot 1—JPEG Slot 2** (as for **Backup**, except that the NEF/RAW copies of photos recorded at settings of NEF/RAW + JPEG are recorded only to the card in Slot 1 and the JPEG copies only to the card in Slot 2).



## **“Backup” and “RAW Slot 1—JPEG Slot 2”**

The camera shows the number of exposures remaining on the card with the least amount of memory. Shutter release will be disabled when either card is full.

## **Recording Movies**

When two memory cards are inserted in the camera, the slot used to record movies can be selected using the **Movie settings > Destination** option in the shooting menu (□ 65).

# Focus

This section describes the focus options available when photographs are framed in the viewfinder. Focus can be adjusted automatically (see below) or manually (☞ 103). The user can also select the focus point for automatic or manual focus (☞ 101) or use focus lock to focus to recompose photographs after focusing (☞ 102).

## Autofocus

To use autofocus, rotate the focus-mode selector to **AF**. *Focus-mode selector*

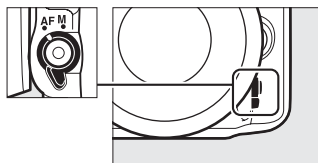

## Autofocus Mode

Choose from the following autofocus modes:

Mode	Description
AF-A	<b>Auto-servo AF:</b> Camera automatically selects single-servo autofocus if subject is stationary, continuous-servo autofocus if subject is moving.
AF-S	<b>Single-servo AF:</b> For stationary subjects. Focus locks when shutter-release button is pressed halfway. At default settings, shutter can only be released when in-focus indicator is displayed ( <i>focus priority</i> ; ☞ 221).
AF-C	<b>Continuous-servo AF:</b> For moving subjects. Camera focuses continuously while shutter-release button is pressed halfway; if subject moves, camera will engage <i>predictive focus tracking</i> (☞ 100) to predict final distance to subject and adjust focus as necessary. At default settings, shutter can be released whether or not subject is in focus ( <i>release priority</i> ; ☞ 221).

### Predictive Focus Tracking

In **AF-C** mode or when continuous-servo autofocus is selected in **AF-A** mode, the camera will initiate predictive focus tracking if the subject moves toward or away from the camera while the shutter-release button is pressed halfway. This allows the camera to track focus while attempting to predict where the subject will be when the shutter is released.

Autofocus mode can be selected by pressing the AF-mode button and rotating the main command dial until the desired setting is displayed in the viewfinder or control panel.



AF-mode button Main command dial

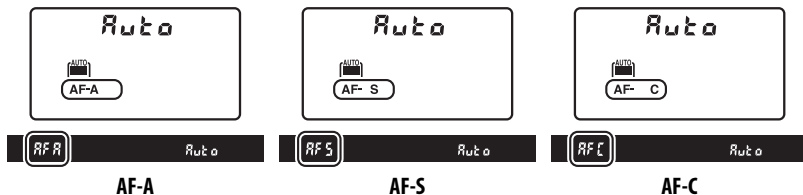

### Getting Good Results with Autofocus

Autofocus does not perform well under the conditions listed below. The shutter release may be disabled if the camera is unable to focus under these conditions, or the in-focus indicator (●) may be displayed and the camera may sound a beep, allowing the shutter to be released even when the subject is not in focus. In these cases, focus manually (103) or use focus lock (102) to focus on another subject at the same distance and then recompose the photograph.



*There is little or no contrast between the subject and the background.*

**Example:** Subject is the same color as the background.

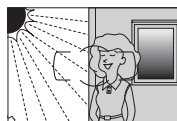

*The focus point contains areas of sharply contrasting brightness.*

**Example:** Subject is half in the shade.



*The focus point contains objects at different distances from the camera.*

**Example:** Subject is inside a cage.

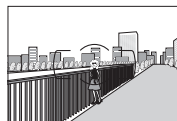

*Background objects appear larger than the subject.*

**Example:** A building is in the frame behind the subject.



*The subject is dominated by regular geometric patterns.*

**Example:** Blinds or a row of windows in a skyscraper.

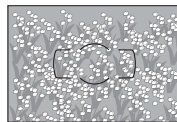

*The subject contains many fine details.*

**Example:** A field of flowers or other subjects that are small or lack variation in brightness.

### See Also

For information on using focus priority in continuous-servo AF, see Custom Setting a1 (**AF-C priority selection**, 221). For information on using release priority in single-servo AF, see Custom Setting a2 (**AF-S priority selection**, 221). See page 51 for information on the autofocus options available in live view or during movie recording.



# AF-Area Mode

Choose how the focus point for autofocus is selected.

- **Single-point AF:** Select the focus point as described on page 101; the camera will focus on the subject in the selected focus point only. Use with stationary subjects.
- **Dynamic-area AF:** Select the focus point as described on page 101. In **AF-A** and **AF-C** focus modes, the camera will focus based on information from surrounding focus points if the subject briefly leaves the selected point. The number of focus points varies with the mode selected:
  - **9-point dynamic-area AF:** Choose when there is time to compose the photograph or when photographing subjects that are moving predictably (e.g., runners or race cars on a track).
  - **21-point dynamic-area AF:** Choose when photographing subjects that are moving unpredictably (e.g., players at a football game).
  - **39-point dynamic-area AF:** Choose when photographing subjects that are moving quickly and can not be easily framed in the viewfinder (e.g., birds).
- **3D-tracking:** Select the focus point as described on page 101. In **AF-A** and **AF-C** focus modes, the camera will track subjects that leave the selected focus point and select new focus points as required. Use to quickly compose pictures with subjects that are moving erratically from side to side (e.g., tennis players). If the subject leaves viewfinder, remove your finger from the shutter-release button and recompose the photograph with the subject in the selected focus point.



- **Auto-area AF:** The camera automatically detects the subject and selects the focus point. If a type G, E, or D lens is used (□ 287), the camera can distinguish human subjects from the background for improved subject detection. The active focus points are highlighted briefly after the camera focuses; in **AF-C** mode or when continuous-servo autofocus is selected in **AF-A** mode, the main focus point remains highlighted after the other focus points have turned off.



AF-area mode can be selected by pressing the AF-mode button and rotating the sub-command dial until the desired setting is displayed in the viewfinder or control panel.

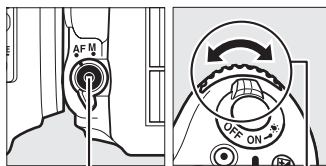

AF-mode button      Sub-command dial

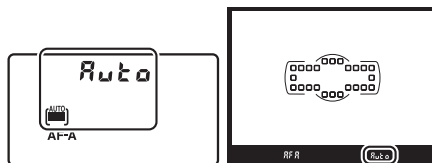

Control panel      Viewfinder

### 3D-tracking

When the shutter-release button is pressed halfway, the colors in the area surrounding the focus point are stored in the camera. Consequently 3D-tracking may not produce the desired results with subjects that are the same color as the background or that occupy a very small area of the frame.

### AF-Area Mode

AF-area mode is shown in the control panel and viewfinder.

AF-area mode	Control panel	Viewfinder	AF-area mode	Control panel	Viewfinder
Single-point AF	S		39-point dynamic-area AF*	d39	
9-point dynamic-area AF*	d 9		3D-tracking	3d	
21-point dynamic-area AF*	d21		Auto-area AF	Auto	

\* Only active focus point is displayed in the viewfinder. Remaining focus points provide information to assist focus operation.

### Manual Focus

Single-point AF is automatically selected when manual focus is used.

### See Also

For information on adjusting how long the camera waits before refocusing when an object moves in front of the camera, see Custom Setting a3 (**Focus tracking with lock-on**, 222). See page 52 for information on the autofocus options available in live view or during movie recording.

# Focus Point Selection

The camera offers a choice of 39 focus points that can be used to compose photographs with the main subject positioned almost anywhere in the frame.

## 1 Rotate the focus selector lock to ●.

This allows the multi selector to be used to select the focus point.

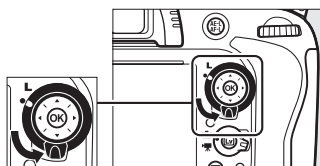

Focus selector lock

## 2 Select the focus point.

Use the multi selector to select the focus point in the viewfinder while the exposure meters are on. Press **OK** to select the center focus point.

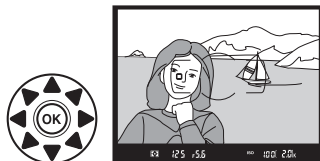

The focus selector lock can be rotated to the locked (L) position following selection to prevent the selected focus point from changing when the multi selector is pressed.

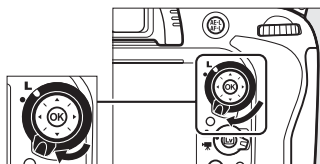

### Auto-area AF

The focus point for auto-area AF is selected automatically; manual focus-point selection is not available.

### See Also

For information on choosing when the focus point is illuminated, see Custom Setting a4 (**AF point illumination**, [□ 222](#)). For information on setting focus-point selection to “wrap around,” see Custom Setting a5 (**Focus point wrap-around**, [□ 222](#)). For information on choosing the number of focus points that can be selected using the multi selector, see Custom Setting a6 (**Number of focus points**, [□ 223](#)). For information on changing the role of the **OK** button, see Custom Setting f1, **OK button (shooting mode)**; [□ 241](#).

# Focus Lock

Focus lock can be used to change the composition after focusing, making it possible to focus on a subject that will not be in a focus point in the final composition. If the camera is unable to focus using autofocus (□ 98), focus lock can also be used to recompose the photograph after focusing on another object at the same distance as your original subject. Focus lock is most effective when an option other than auto-area AF is selected for AF-area mode (□ 99).

## 1 Focus.

Position the subject in the selected focus point and press the shutter-release button halfway to initiate focus. Check that the in-focus indicator (●) appears in the viewfinder.



## 2 Lock focus.

**AF-A and AF-C focus modes:** With the shutter-release button pressed halfway (①), press the  $\text{AE-L/AF-L}$  button (②) to lock both focus and exposure (an **AE-L** icon will be displayed in the viewfinder). Focus will remain locked while the  $\text{AE-L/AF-L}$  button is pressed, even if you later remove your finger from the shutter-release button.

**AF-S focus mode:** Focus locks automatically when the in-focus indicator appears, and remain locked until you remove your finger from the shutter-release button. Focus can also be locked by pressing the  $\text{AE-L/AF-L}$  button (see above).

Shutter-release button

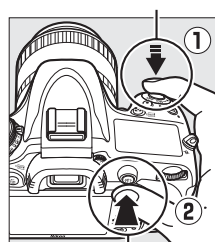

$\text{AE-L/AF-L}$  button



## 3 Recompose the photograph and shoot.

Focus will remain locked between shots if you keep the shutter-release button pressed halfway (AF-S) or keep the  $\text{AE-L/AF-L}$  button pressed, allowing several photographs in succession to be taken at the same focus setting.



Do not change the distance between the camera and the subject while focus lock is in effect. If the subject moves, focus again at the new distance.

### See Also

See Custom setting c1 (**Shutter-release button AE-L**, □ 226) for information on using the shutter-release button to lock exposure, Custom Setting f4 (**Assign AE-L/AF-L button**, □ 244) for information on choosing the role played by the  $\text{AE-L/AF-L}$  button.

# Manual Focus

Manual focus is available for lenses that do not support autofocus (non-AF NIKKOR lenses) or when the autofocus does not produce the desired results (☐ 98).

- **AF-S lenses:** Set the lens focus mode switch to **M**.
- **AF lenses:** Set the lens focus mode switch (if present) and camera focus-mode selector to **M**.

Focus-mode selector

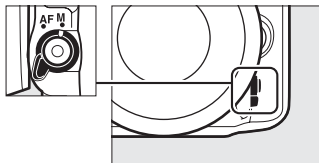

## ✓ AF Lenses

Do not use AF lenses with the lens focus mode switch set to **M** and the camera focus-mode selector set to **AF**. Failure to observe this precaution could damage the camera or lens.

- **Manual focus lenses:** Set the camera focus-mode selector to **M**.

To focus manually, adjust the lens focus ring until the image displayed on the clear matte field in the viewfinder is in focus. Photographs can be taken at any time, even when the image is not in focus.

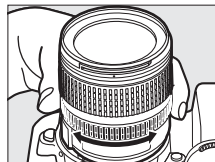

## ■ The Electronic Rangefinder

If the lens has a maximum aperture of  $f/5.6$  or faster, the viewfinder focus indicator can be used to confirm whether the subject in the selected focus point is in focus (the focus point can be selected from any of the 39 focus points). After positioning the subject in the selected focus point, press the shutter-release button halfway and rotate the lens focus ring until the in-focus indicator (●) is displayed.

Note that with the subjects listed on page 98, the in-focus indicator may sometimes be displayed when the subject is not in focus; confirm focus in the viewfinder before shooting.



## ✎ Focal Plane Position

To determine the distance between your subject and the camera, measure from the focal plane mark (⊖) on the camera body. The distance between the lens mounting flange and the focal plane is 46.5 mm (1.83 in.).

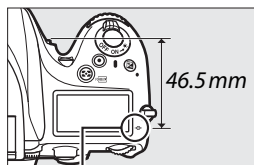

Focal plane mark



# ISO Sensitivity

“ISO sensitivity” is the digital equivalent of film speed. Choose from settings that range from ISO 100 to ISO 6400 in steps equivalent to  $\frac{1}{3}$  EV. Settings of from about 0.3 to 1 EV below ISO 100 and 0.3 to 2 EV above ISO 6400 are also available for special situations. Auto and scene modes also offer an **AUTO** option, which allows the camera to set ISO sensitivity automatically in response to lighting conditions. The higher the ISO sensitivity, the less light needed to make an exposure, allowing higher shutter speeds or smaller apertures.

ISO sensitivity can be adjusted by pressing the **ISO** button and rotating the main command dial until the desired setting is displayed in the control panel or viewfinder.

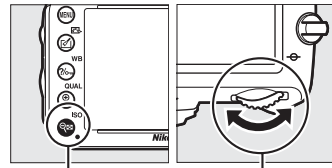

**ISO** button Main command dial

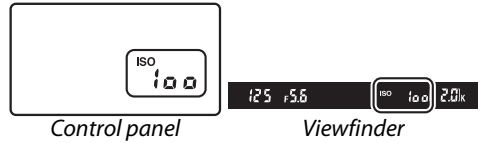

Control panel

Viewfinder

## **AUTO**

If the mode dial is rotated to **P**, **S**, **A**, or **M** after **AUTO** is selected for ISO sensitivity in another mode, the ISO sensitivity last selected in **P**, **S**, **A**, or **M** mode will be restored.

## **Hi 0.3–Hi 2**

The settings **Hi 0.3** through **Hi 2** correspond to ISO sensitivities 0.3–2 EV over ISO 6400 (ISO 8000–25600 equivalent). Pictures taken at these settings are more likely to be subject to noise (randomly-spaced bright pixels, fog, or lines).

## **Lo 0.3–Lo 1**

The settings **Lo 0.3** through **Lo 1** correspond to ISO sensitivities 0.3–1 EV below ISO 100 (ISO 80–50 equivalent). Use for larger apertures when lighting is bright. Contrast is slightly higher than normal; in most cases, ISO sensitivities of ISO 100 or above are recommended.

## **The Shooting Menu**

ISO sensitivity can also be adjusted using the **ISO sensitivity settings** option in the shooting menu (☞ 214).



## **See Also**

For information on choosing the ISO sensitivity step size, see Custom Setting b1 (**ISO sensitivity step value**; ☞ 224). For information on displaying ISO sensitivity in the control panel or adjusting ISO sensitivity without using the  (**ISO**) button, see Custom Setting d3 (**ISO display and adjustment**; ☞ 229). For information on using the **High ISO NR** option in the shooting menu to reduce noise at high ISO sensitivities, see page 218.



# Auto ISO Sensitivity Control (P, S, A, and M Modes Only)

If **On** is selected for **ISO sensitivity settings** > **Auto ISO sensitivity control** in the shooting menu, ISO sensitivity will automatically be adjusted if optimal exposure can not be achieved at the value selected by the user (ISO sensitivity is adjusted appropriately when the flash is used).

## 1 Select Auto ISO sensitivity control for ISO sensitivity settings in the shooting menu.

To display the menus, press the **MENU** button. Select **ISO sensitivity settings** in the shooting menu, highlight **Auto ISO sensitivity control** and press **▶**.

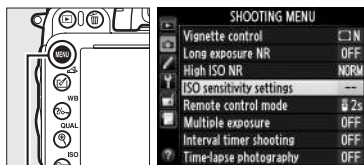

MENU button

## 2 Select On.

Highlight **On** and press **OK** (if **Off** is selected, ISO sensitivity will remain fixed at the value selected by the user).

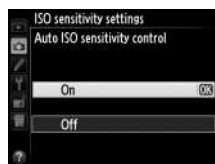

## 3 Adjust settings.

The maximum value for auto ISO sensitivity can be selected using **Maximum sensitivity** (the minimum value for auto ISO sensitivity is automatically set to ISO 100; note that if the value selected for **Maximum sensitivity** is lower than the value currently selected for **ISO sensitivity**, the value selected for **Maximum sensitivity** will be used). In modes **P** and **A**, sensitivity will only be adjusted if underexposure would result at the shutter speed selected for **Minimum shutter speed** ( $1/2000$ – $1$  s, or **Auto**; in modes **S** and **M**, ISO sensitivity will be adjusted for optimal exposure at the shutter speed selected by the user). If **Auto** (available only with CPU lenses; equivalent to  $1/30$  s when a non-CPU lens is used) is selected, the camera will choose the minimum shutter speed based on the focal length of the lens (auto shutter-speed selection can be fine-tuned by highlighting **Auto** and pressing **▶**; for example, even faster values than those usually selected automatically by the camera can be used with telephoto lenses to reduce blur). Shutter speeds slower than the minimum value may be used if optimum exposure can not be achieved at the ISO sensitivity value selected for **Maximum sensitivity**. Press **OK** to exit when settings are complete.

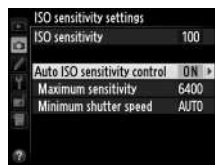

ISO

When **On** is selected, the viewfinder and control panel show **ISO-AUTO**. When sensitivity is altered from the value selected by the user, these indicators flash and the altered value is shown in viewfinder.

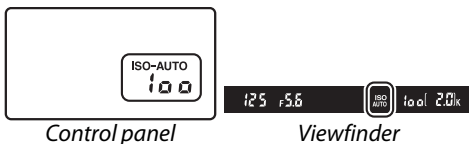

### Auto ISO Sensitivity Control

Noise (randomly-spaced bright pixels, fog, or lines) is more likely at higher sensitivities. Use the **High ISO NR** option in the shooting menu to reduce noise (see page 218). When a flash is used, the value selected for **Minimum shutter speed** is ignored in favor of the option selected for Custom Setting e1 (**Flash sync speed**, □ 234). Note that ISO sensitivity may be raised automatically when auto ISO sensitivity control is used in combination with slow sync flash modes (available with the built-in flash and the optional flash units listed on page 293), possibly preventing the camera from selecting slow shutter speeds.

### Turning Auto ISO Sensitivity Control On or Off

You can turn auto ISO sensitivity control on or off by pressing the **Q** (ISO) button and rotating the sub-command dial. **ISO-AUTO** is displayed when auto ISO sensitivity control is on.

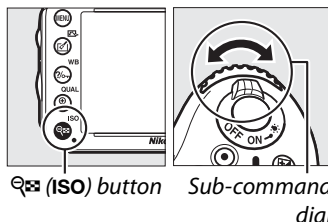



# Exposure

## Metering

(P, S, A, and M Modes Only)

Choose how the camera sets exposure in **P**, **S**, **A**, and **M** modes (in other modes, the camera selects the metering method automatically).

Option	Description
	<b>Matrix:</b> Produces natural results in most situations. Camera meters a wide area of the frame and set exposure according to tone distribution, color, composition, and, with type G, E, or D lenses (📖 287), distance information (3D color matrix metering II; with other CPU lenses, camera uses color matrix metering II, which does not include 3D distance information). With non-CPU lenses, camera uses color matrix metering if focal length and maximum aperture are specified using <b>Non-CPU lens data</b> option in setup menu (📖 173); otherwise camera uses center-weighted metering.
	<b>Center-weighted:</b> Camera meters entire frame but assigns greatest weight to center area (if CPU lens is attached, size of area can be selected using Custom Setting b4, <b>Center-weighted area</b> , 📖 226; if non-CPU lens is attached, area is 12 mm in diameter). Classic meter for portraits; recommended when using filters with an exposure factor (filter factor) over 1x.*
	<b>Spot:</b> Camera meters circle 4 mm (0.16 in.) in diameter (approximately 1.5% of frame). Circle is centered on current focus point, making it possible to meter off-center subjects (if non-CPU lens is used or if auto-area AF is in effect, camera will meter center focus point). Ensures that subject will be correctly exposed, even when background is much brighter or darker.*

\* For improved precision with non-CPU lenses, specify lens focal length and maximum aperture in **Non-CPU lens data** menu (📖 173).

To choose a metering option, press the (FORMAT) button and rotate the main command dial until the desired setting is displayed in the viewfinder and control panel.

### See Also

For information on making separate adjustments to optimal exposure for each metering method, see Custom Setting b5 (**Fine-tune optimal exposure**, 📖 226).

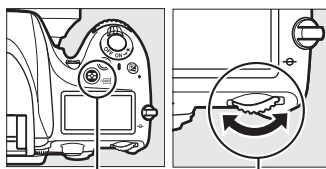

(FORMAT) button    Main command dial



Control panel

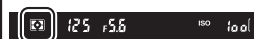

Viewfinder



# Autoexposure Lock

Use autoexposure lock to recompose photographs after using center-weighted metering and spot metering to meter exposure. Note that matrix metering will not produce the desired results.

## 1 Lock exposure.

Position the subject in the selected focus point and press the shutter-release button halfway. With the shutter-release button pressed halfway and the subject positioned in the focus point, press the  $\begin{smallmatrix} \text{AE-L} \\ \text{AF-L} \end{smallmatrix}$  **AE-L/AF-L** button to lock focus and exposure (if you are using autofocus, confirm that the ● in-focus indicator appears in the viewfinder).

While exposure lock is in effect, an **AE-L** indicator will appear in the viewfinder.

Shutter-release button

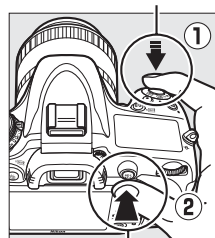

$\begin{smallmatrix} \text{AE-L} \\ \text{AF-L} \end{smallmatrix}$  AE-L/AF-L button



## 2 Recompose the photograph.

Keeping the  $\begin{smallmatrix} \text{AE-L} \\ \text{AF-L} \end{smallmatrix}$  **AE-L/AF-L** button pressed, recompose the photograph and shoot.

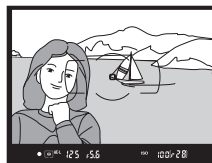

### **Metered Area**

In spot metering, exposure will be locked at the value metered in a 4-mm (0.16 in.) circle centered on the selected focus point. In center-weighted metering, exposure will be locked at the value metered in a 12-mm circle in the center of the viewfinder.



### **Adjusting Shutter Speed and Aperture**

While exposure lock is in effect, the following settings can be adjusted without altering the metered value for exposure:

Mode	Setting
P	Shutter speed and aperture (flexible program;  75)
S	Shutter speed
A	Aperture

The new values can be confirmed in the viewfinder and control panel. Note that metering can not be changed while exposure lock is in effect.

### **See Also**

If **On** is selected for Custom Setting c1 (**Shutter-release button AE-L**,  226), exposure will lock when the shutter-release button is pressed halfway. For information on changing the role of the  **AE-L/AF-L** button, see Custom Setting f4 (**Assign AE-L/AF-L button**,  244).



# Exposure Compensation

(P, S, A, and M Modes Only)

Exposure compensation is used to alter exposure from the value suggested by the camera, making pictures brighter or darker. It is most effective when used with center-weighted or spot metering (☐ 109). Choose from values between  $-5$  EV (underexposure) and  $+5$  EV (overexposure) in increments of  $1/3$  EV. In general, positive values make the subject brighter while negative values make it darker.



$-1$  EV



No exposure compensation



$+1$  EV

To choose a value for exposure compensation, press the  button and rotate the main command dial until the desired value is displayed in the control panel or viewfinder.

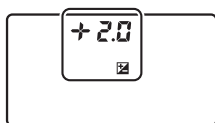
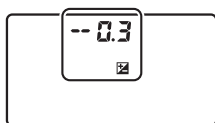
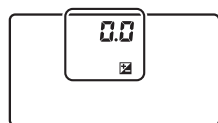

$\pm 0$  EV

( button pressed)





$-0.3$  EV

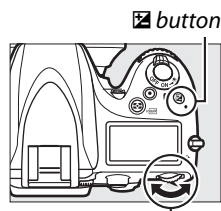

$+2.0$  EV



Main command dial

At values other than  $\pm 0.0$ , the 0 at the center of the exposure indicators will flash (modes P, S, and A only) and a  icon will be displayed in the control panel and viewfinder after you release the  button. The current value for exposure compensation can be confirmed in the exposure indicator by pressing the  button.

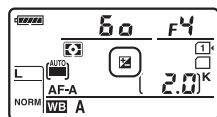

Normal exposure can be restored by setting exposure compensation to  $\pm 0$ . Exposure compensation is not reset when the camera is turned off.



### **Mode M**

In mode **M**, exposure compensation affects only the exposure indicator; shutter speed and aperture do not change.

### **Using a Flash**

When a flash is used, exposure compensation affects both flash level and exposure, altering the brightness of both the main subject and the background. Custom Setting e4 (**Exposure comp. for flash**,  240) can be used to restrict the effects of exposure compensation to the background only.

### **See Also**

For information on choosing the size of the increments available for exposure compensation, see Custom Setting b2 (**EV steps for exposure cntrl**,  224). For information on making adjustments to exposure compensation without pressing the  button, see Custom Setting b3 (**Easy exposure compensation**,  225). For information on automatically varying exposure, flash level, white balance, or Active D-Lighting, see page 153.















# White Balance

(P, S, A, and M Modes Only)

White balance ensures that colors are unaffected by the color of the light source. In modes other than **P**, **S**, **A**, and **M**, white balance is set automatically by the camera. Auto white balance is recommended for most light sources in **P**, **S**, **A**, and **M** modes, but other values can be selected if necessary according to the type of source:

Option	Colortemp.*	Description
<b>AUTO</b> <b>Auto</b>	3,500–8,000 K	White balance is adjusted automatically. For best results, use type G, E, or D lens. If built-in or optional flash fires, results are adjusted for flash.
<b>Normal</b>		
<b>Keep warm lighting colors</b>		
 <b>Incandescent</b>	3,000 K	Use under incandescent lighting.
 <b>Fluorescent</b>		Use with:
<b>Sodium-vapor lamps</b>	2,700 K	• Sodium-vapor lighting (found in sports venues).
<b>Warm-white fluorescent</b>	3,000 K	• Warm-white fluorescent lights.
<b>White fluorescent</b>	3,700 K	• White fluorescent lights.
<b>Cool-white fluorescent</b>	4,200 K	• Cool-white fluorescent lights.
<b>Day white fluorescent</b>	5,000 K	• Daylight white fluorescent lights.
<b>Daylight fluorescent</b>	6,500 K	• Daylight fluorescent lights.
<b>High temp. mercury-vapor</b>	7,200 K	• High color temperature light sources (e.g. mercury-vapor lamps).
 <b>Direct sunlight</b>	5,200 K	Use with subjects lit by direct sunlight.
 <b>Flash</b>	5,400 K	Use with built-in or optional flash.
 <b>Cloudy</b>	6,000 K	Use in daylight under overcast skies.
 <b>Shade</b>	8,000 K	Use in daylight with subjects in the shade.
 <b>Choose color temp.</b>	2,500–10,000 K	Choose color temperature from list of values (☞ 120).
<b>PRE</b> <b>Preset manual</b>	—	Use subject, light source, or existing photograph as reference for white balance (☞ 121).

\* All values are approximate and do not reflect fine-tuning (if applicable).

White balance is set by pressing the  (**WB**) button and rotating the main command dial until the desired setting is displayed in the control panel.

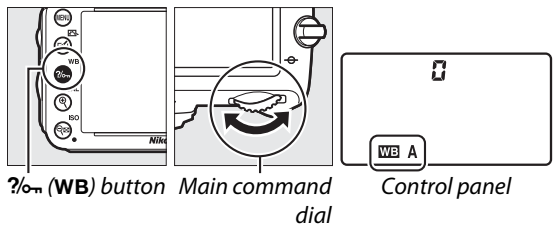

## The Shooting Menu

White balance can also be adjusted using the **White balance** option in the shooting menu (☐ 214), which also can be used to fine-tune white balance (☐ 117) or measure a value for preset white balance (☐ 121). The **Auto** option in the **White balance** menu offers a choice of **Normal** and **Keep warm lighting colors**, which preserves the warm colors produced by incandescent lighting, while the  **Fluorescent** option can be used to select the light source from the bulb types.















## Studio Flash Lighting

Auto white balance may not produce the desired results with large studio flash units. Use preset white balance or set white balance to **Flash** and use fine tuning to adjust white balance.

## Color Temperature

The perceived color of a light source varies with the viewer and other conditions. Color temperature is an objective measure of the color of a light source, defined with reference to the temperature to which an object would have to be heated to radiate light in the same wavelengths. While light sources with a color temperature in the neighborhood of 5,000–5,500 K appear white, light sources with a lower color temperature, such as incandescent light bulbs, appear slightly yellow or red. Light sources with a higher color temperature appear tinged with blue. The camera white balance options are adapted to the following color temperatures:

-  (sodium-vapor lamps): **2,700 K**
-  (incandescent)/  
•  (warm-white fluorescent): **3,000 K**
-  (white fluorescent): **3,700 K**
-  (cool-white fluorescent): **4,200 K**
-  (day white fluorescent): **5,000 K**
-  (direct sunlight): **5,200 K**
-  (flash): **5,400 K**
-  (cloudy): **6,000 K**
-  (daylight fluorescent): **6,500 K**
-  (high temp. mercury-vapor): **7,200 K**
-  (shade): **8,000 K**

## See Also

When **WB bracketing** is selected for Custom Setting e6 (**Auto bracketing set**, ☐ 241), the camera will create several images each time the shutter is released. White balance will be varied with each image, “bracketing” the value currently selected for white balance (☐ 156).

# Fine-Tuning White Balance

White balance can be “fine-tuned” to compensate for variations in the color of the light source or to introduce a deliberate color cast into an image. White balance is fine-tuned using the **White balance** option in the shooting menu or by pressing the **WB** button and rotating the sub-command dial.

## ■ The White Balance Menu

### 1 Select a white balance option in the shooting menu.

To display the menu, press the **MENU** button. Select **White balance** in the shooting menu, then highlight a white balance option and press **▶**. If an option other than **Auto**, **Fluorescent**, **Choose color temp.**, or **Preset manual** is selected, proceed to Step 2. If **Auto**, **Fluorescent**, or **Choose color temp.** is selected, highlight the desired setting and press **▶**. For information on fine-tuning preset white balance, see page 125.

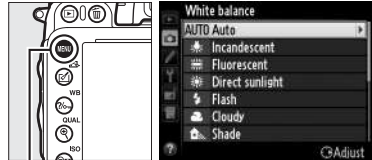

MENU button

### 2 Fine tune white balance.

Use the multi selector to fine-tune white balance. White balance can be fine-tuned on the amber (A)–blue (B) axis and the green (G)–magenta (M) axis. The horizontal (amber–blue) axis corresponds to color temperature, with each increment equivalent to about 5 mired. The vertical (green–magenta) axis has the similar effects to the corresponding color compensation (CC) filters.

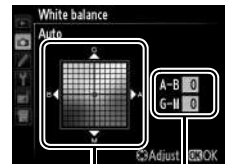

Coordinates

Adjustment

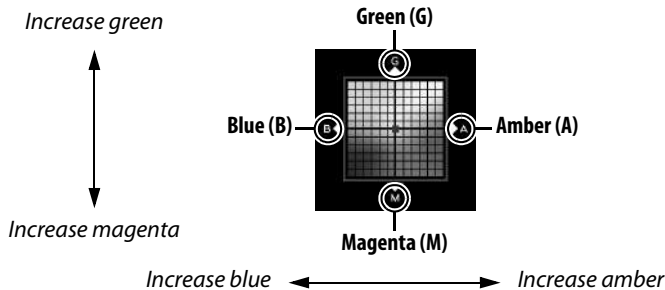

### 3 Press **OK**.

Press **OK** to save settings and return to the shooting menu. If white balance has been fine-tuned, an asterisk ("**\***") will be displayed in the control panel.

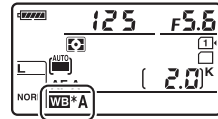

### ■ ■ The **WB** Button

At settings other than **☑ (Choose color temp.)** and **PRE (Preset manual)**, the **WB** button can be used to fine-tune white balance on the amber (A)–blue (B) axis (☐ 117; to fine-tune white balance when **☑** or **PRE** is selected, use the shooting menu as described on page 117). Six settings in both directions are available; each increment is equivalent to about 5 mired (☐ 119). Press the **WB** button and rotate the sub-command dial until the desired value is displayed in the control panel. Rotating the sub-command dial to the left increases the amount of amber (A). Rotating the sub-command dial to the right increases the amount of blue (B). At settings other than 0, an asterisk ("**\***") appears in the control panel.

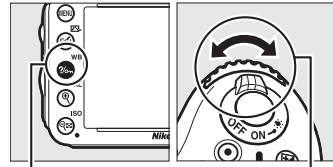

**WB** button      Sub-command dial

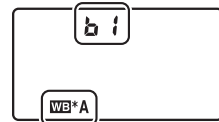

Control panel

### **White Balance Fine-Tuning**

The colors on the fine-tuning axes are relative, not absolute. For example, moving the cursor to **B** (blue) when a “warm” setting such as  (incandescent) is selected for white balance will make photographs slightly “colder” but will not actually make them blue.

### **Color Temperature Fine-Tuning**

When **Choose color temp.** is selected, you can view the color temperature while fine-tuning white balance.

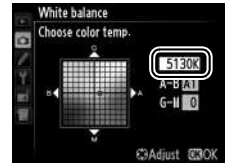

### **“Mired”**

Any given change in color temperature produces a greater difference in color at low color temperatures than it would at higher color temperatures. For example, a change of 1000 K produces a much greater change in color at 3000 K than at 6000 K. Mired, calculated by multiplying the inverse of the color temperature by  $10^6$ , is a measure of color temperature that takes such variation into account, and as such is the unit used in color-temperature compensation filters. E.g.:

- 4000 K–3000 K (a difference of 1000 K)=83 mired
- 7000 K–6000 K (a difference of 1000 K)=24 mired

# Choosing a Color Temperature

When **☑ (Choose color temp.)** is selected for white balance, color temperature can be selected by pressing the **WB** button and rotating the sub-command dial. The color temperature is displayed in the control panel.

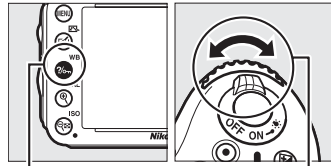

**WB** button      Sub-command dial

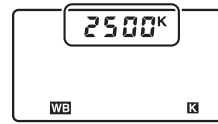

Control panel

WB

## **☑ Choose Color Temperature**

Note that the desired results will not be obtained with flash or fluorescent lighting. Choose **⚡ (Flash)** or **☀ (Fluorescent)** for these sources. With other light sources, take a test shot to determine if the selected value is appropriate.

## **✎ The White Balance Menu**

Color temperature can also be selected in the white balance menu. Note that the color temperature with the **WB** button and the sub-command dial replaces the value selected in the white balance menu.



# Preset Manual

Preset manual is used to record and recall custom white balance settings for shooting under mixed lighting or to compensate for light sources with a strong color cast. The camera can store up to four values for preset white balance in presets d-1 through d-4. Two methods are available for setting preset white balance:

Method	Description
Direct measurement	Neutral gray or white object is placed under lighting that will be used in final photo and white balance measured by camera (☐ 121).
Copy from existing photograph	White balance is copied from photo on memory card (☐ 124).

## ■ Measuring a Value for White Balance

### 1 Light a reference object.

Place a neutral gray or white object under the lighting that will be used in the final photograph. In studio settings, a standard gray panel can be used as a reference object. Note that exposure is automatically increased by 1 EV when measuring white balance; in mode **M**, adjust exposure so that the exposure indicator shows  $\pm 0$  (☐ 78).

### 2 Set white balance to PRE (Preset manual).

Press the  $\frac{1}{2}$  (WB) button and rotate the main command dial until **PRE** is displayed in the control panel.

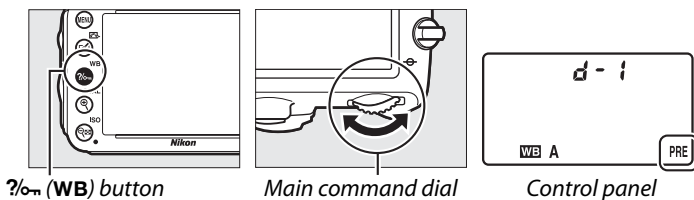

### ✎ Measuring Preset White Balance

Preset manual white balance can not be measured during live view (☐ 49, 57), while you are shooting an HDR photograph (☐ 139) or multiple exposure (☐ 160), or when **Record movies** is selected for Custom Setting g4 (**Assign shutter button**, ☐ 248).

### 3 Select a preset.

Press the **WB** button and rotate the sub-command dial until the desired white balance preset (d-1 to d-4) is displayed in the control panel.

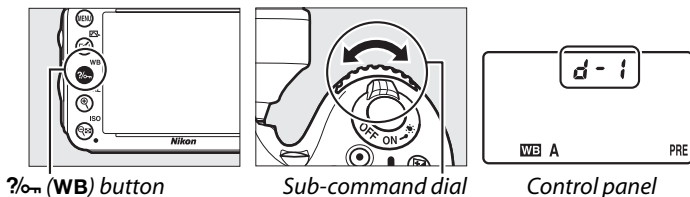

### 4 Select direct measurement mode.

Release the **WB** button briefly and then press the button until the **PRE** icon in the control panel starts to flash. A flashing **Pr-E** will also appear in the viewfinder. The displays will flash for about six seconds.

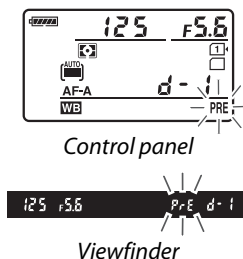

### 5 Measure white balance.

Before the indicators stop flashing, frame the reference object so that it fills the viewfinder and press the shutter-release button all the way down. The camera will measure a value for white balance and store it in the preset selected in Step 3. No photograph will be recorded; white balance can be measured accurately even when the camera is not in focus.



#### Protected Presets

If the current preset is protected (□ 127), **Pr-E** will flash in the control panel and viewfinder if you attempt to measure a new value.



## 6 Check the results.

If the camera was able to measure a value for white balance, **Good** will flash in the control panel for about six seconds, while the viewfinder will show a flashing **Good**.

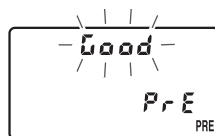

Control panel



Viewfinder

If lighting is too dark or too bright, the camera may be unable to measure white balance. A flashing **no Good** will appear in the control panel and viewfinder for about six seconds. Press the shutter-release button halfway to return to Step 5 and measure white balance again.

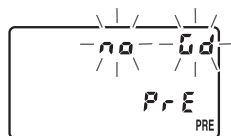

Control panel



Viewfinder

### Direct Measurement Mode

If no operations are performed while the displays are flashing, direct measurement mode will end in the time selected for Custom Setting c2 (**Standby timer**, □ 227).

### Selecting a Preset

Selecting **Preset manual** for the **White balance** option in the shooting menu displays the dialog shown at right; highlight a preset and press . If no value currently exists for the selected preset, white balance will be set to 5,200 K, the same as **Direct sunlight**.



## ■ Copying White Balance from a Photograph

Follow the steps below to copy a value for white balance from an existing photograph to a selected preset.

### 1 Select PRE (Preset manual) for White balance in the shooting menu.

Press the MENU button and select **White balance** in the shooting menu. Highlight **Preset manual** and press ►.

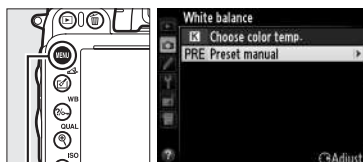

MENU button

### 2 Select a destination.

Highlight the destination preset (d-1 to d-4) and press **ISO**.

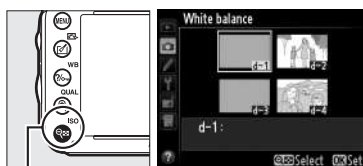

ISO button

### 3 Choose Select image.

Highlight **Select image** and press ►.



### 4 Highlight a source image.

Highlight the source image.



### 5 Press OK.

Press **OK** to copy the white balance value for the highlighted photograph to the selected preset. If the highlighted photograph has a comment (253), the comment will be copied to the comment for the selected preset.



### **Choosing a Source Image**

To view the image highlighted in Step 4 full frame, press and hold the **QUAL** button.



**QUAL** button

To view images in other locations, hold the **BKT** button and press **▲**. The dialog shown at right will be displayed; select the desired card and folder ( 178).



**BKT** button

### **Choosing a White Balance Preset**

Press **▲** to highlight the current white balance preset (d-1 – d-4) and press **▶** to select another preset.

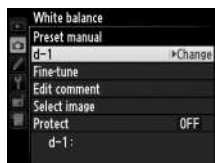

### **Fine-Tuning Preset White Balance**

The selected preset can be fine-tuned by selecting **Fine-tune** and adjusting white balance as described on page 117.

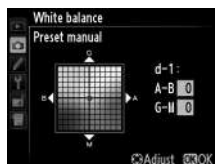

## ■ ■ Entering a Comment

Follow the steps below to enter a descriptive comment of up to thirty-six characters for a selected white balance preset.

### 1 Select PRE (Preset manual).

Highlight **Preset manual** in the white balance menu and press ►.

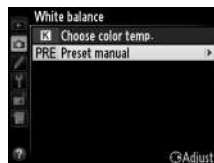

### 2 Select a preset.

Highlight the desired preset and press  (ISO).

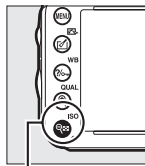

 (ISO) button



### 3 Select Edit comment.

Highlight **Edit comment** and press ►.



### 4 Edit the comment.

Edit the comment as described on page 135.



## ■ ■ Protecting a White Balance Preset

Follow the steps below to protect the selected white balance preset. Protected presets can not be modified and the **Fine-tune** and **Edit comment** options can not be used.

### 1 Select PRE (Preset manual).

Highlight **Preset manual** in the white balance menu and press ►.

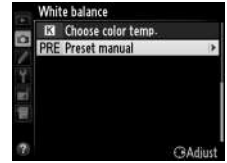

### 2 Select a preset.

Highlight the desired preset and press  (ISO).

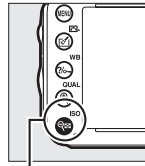

 (ISO) button



### 3 Select Protect.

Highlight **Protect** and press ►.

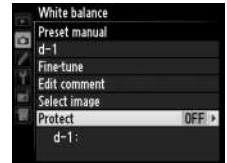

### 4 Select On.

Highlight **On** and press  to protect the selected white balance preset. To remove protection, select **Off**.

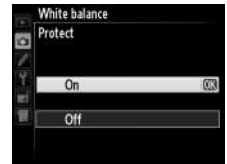





# Image Enhancement

## Picture Controls

(P, S, A, and M Modes Only)

Nikon's unique Picture Control system makes it possible to share image processing settings, including sharpening, contrast, brightness, saturation, and hue, among compatible devices and software.

### Selecting a Picture Control

The camera offers a choice of preset Picture Controls. In **P**, **S**, **A**, and **M** modes, you can choose a Picture Control according to the subject or type of scene (in other modes, the camera selects a Picture Control automatically).

Option	Description
<b>Standard</b>	Standard processing for balanced results. Recommended for most situations.
<b>Neutral</b>	Minimal processing for natural results. Choose for photographs that will later be extensively processed or retouched.
<b>Vivid</b>	Pictures are enhanced for a vivid, photoprint effect. Choose for photographs that emphasize primary colors.
<b>Monochrome</b>	Take monochrome photographs.
<b>Portrait</b>	Process portraits for skin with natural texture and a rounded feel.
<b>Landscape</b>	Produces vibrant landscapes and cityscapes.

#### 1 Press (P).

A list of Picture Controls will be displayed.

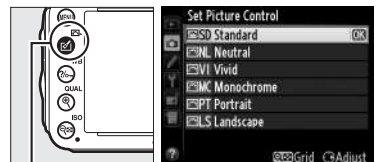

button

#### 2 Choose a Picture Control.

Highlight the desired Picture Control and press .



### **Custom Picture Controls**

Custom Picture Controls are created through modifications to existing Picture Controls using the **Manage Picture Control** option in the shooting menu (☞ 134). Custom Picture Controls can be saved to a memory card for sharing among other cameras of the same model and compatible software (☞ 136).

### **The Picture Control Indicator**

The current Picture Control is shown in the information display when the  button is pressed.



*Picture Control indicator*

### **The Shooting Menu**

Picture Controls can also be selected using the **Set Picture Control** option in the shooting menu (☞ 214).





# Modifying Picture Controls

Existing preset or custom Picture Controls (□ 134) can be modified to suit the scene or the user's creative intent. Choose a balanced combination of settings using **Quick adjust**, or make manual adjustments to individual settings.

## 1 Select a Picture Control.

Highlight the desired Picture Control in the Picture Control list (□ 129) and press ►.



## 2 Adjust settings.

Press ▲ or ▼ to highlight the desired setting (□ 132) and press ◀ or ▶ to choose a value. Repeat this step until all settings have been adjusted, or select **Quick adjust** to choose a preset combination of settings. Default settings can be restored by pressing the  (FORMAT) button.

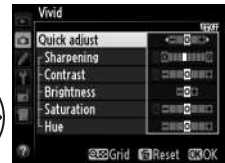

## 3 Press OK.

### Modifications to Original Picture Controls

Picture Controls that have been modified from default settings are indicated by an asterisk ("\*").



## Picture Control Settings

Option	Description
Quick adjust	Choose from options between <b>-2</b> and <b>+2</b> to reduce or exaggerate the effect of the selected Picture Control (note that this resets all manual adjustments). For example, choosing positive values for <b>Vivid</b> makes pictures more vivid. Not available with <b>Neutral</b> or <b>Monochrome</b> Picture Controls.
Manual adjustments (all Picture Controls)	<b>Sharpening</b> Control the sharpness of outlines. Select <b>A</b> to adjust sharpening automatically according to the type of scene, or choose from values between <b>0</b> (no sharpening) and <b>9</b> (the higher the value, the greater the sharpening).
	<b>Contrast</b> Select <b>A</b> to adjust contrast automatically according to the type of scene, or choose from values between <b>-3</b> and <b>+3</b> (choose lower values to prevent highlights in portrait subjects from being “washed out” in direct sunlight, higher values to preserve detail in misty landscapes and other low-contrast subjects).
	<b>Brightness</b> Choose <b>-1</b> for reduced brightness, <b>+1</b> for enhanced brightness. Does not affect exposure.
Manual adjustments (non-monochrome only)	<b>Saturation</b> Control the vividness of colors. Select <b>A</b> to adjust saturation automatically according to the type of scene, or choose from values between <b>-3</b> and <b>+3</b> (lower values reduce saturation and higher values increase it).
	<b>Hue</b> Choose negative values (to a minimum of <b>-3</b> ) to make reds more purple, blues more green, and greens more yellow, positive values (up to <b>+3</b> ) to make reds more orange, greens more blue, and blues more purple.
Manual adjustments (monochrome only)	<b>Filter effects</b> Simulate the effect of color filters on monochrome photographs. Choose from <b>Off</b> , yellow, orange, red, and green (☐ 133).
	<b>Toning</b> Choose the tint used in monochrome photographs from <b>B&amp;W</b> (black-and-white), <b>Sepia</b> , <b>Cyanotype</b> (blue-tinted monochrome), <b>Red</b> , <b>Yellow</b> , <b>Green</b> , <b>Blue Green</b> , <b>Blue</b> , <b>Purple Blue</b> , <b>Red Purple</b> (☐ 133).

### ✓ “A” (Auto)

Results for auto sharpening, contrast, and saturation vary with exposure and the position of the subject in the frame. Use a type G, E, or D lens for best results.

### ✎ Custom Picture Controls

The options available with custom Picture Controls are the same as those on which the custom Picture Control was based.

## The Picture Control Grid

Pressing the **Q** (ISO) button in Step 2 on page 131 displays a Picture Control grid showing the contrast and saturation for the selected Picture Control in relation to the other Picture Controls (only contrast is displayed when **Monochrome** is selected). Release the **Q** (ISO) button to return to the Picture Control menu.

The icons for Picture Controls that use auto contrast and saturation are displayed in green in the Picture Control grid, and lines appear parallel to the axes of the grid.

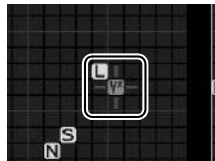
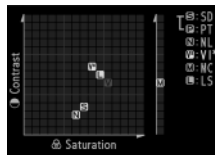

## Previous Settings

The line under the value display in the Picture Control setting menu indicates the previous value for the setting. Use this as a reference when adjusting settings.



## Filter Effects (Monochrome Only)

The options in this menu simulate the effect of color filters on monochrome photographs. The following filter effects are available:

Option	Description
<b>Y</b> Yellow	Enhances contrast. Can be used to tone down the brightness of the sky in landscape photographs.
<b>O</b> Orange	Orange produces more contrast than yellow, red more contrast than orange.
<b>R</b> Red	
<b>G</b> Green	Softens skin tones. Can be used for portraits.

Note that the effects achieved with **Filter effects** are more pronounced than those produced by physical glass filters.

## Toning (Monochrome Only)

Pressing **▼** when **Toning** is selected displays saturation options. Press **◀** or **▶** to adjust saturation. Saturation control is not available when **B&W** (black-and-white) is selected.



# Creating Custom Picture Controls

The Picture Controls supplied with the camera can be modified and saved as custom Picture Controls.

## 1 Select Manage Picture Control in the shooting menu.

To display the menus, press the MENU button. Highlight **Manage Picture Control** in the shooting menu and press ►.

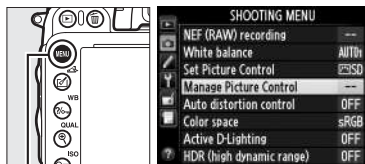

MENU button

## 2 Select Save/edit.

Highlight **Save/edit** and press ►.



## 3 Select a Picture Control.

Highlight an existing Picture Control and press ►, or press **OK** to proceed to Step 5 to save a copy of the highlighted Picture Control without further modification.



## 4 Edit the selected Picture Control.

See page 132 for more information. To abandon any changes and start over from default settings, press the **FORMAT** button. Press **OK** when settings are complete.



## 5 Select a destination.

Choose a destination for the custom Picture Control (C-1 through C-9) and press ►.



## 6 Name the Picture Control.

The text-entry dialog shown at right will be displayed. By default, new Picture Controls are named by adding a two-digit number (assigned automatically) to the name of the existing Picture Control; to use the default name, proceed to Step 7. To move the cursor in the name area, hold the **ISO** button and press **◀** or **▶**. To enter a new letter at the current cursor position, use the multi selector to highlight the desired character in the keyboard area and press **OK**. To delete the character at the current cursor position, press the **FORMAT** button.

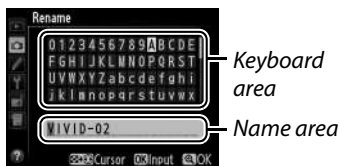

Custom Picture Control names can be up to nineteen characters long. Any characters after the nineteenth will be deleted.

## 7 Press **QUAL**.

Press the **QUAL** button to save changes and exit. The new Picture Control will appear in the Picture Control list.

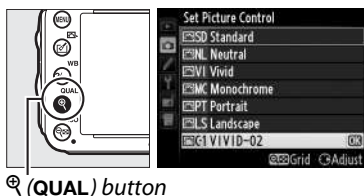

**QUAL** button

### **Manage Picture Control > Rename**

Custom Picture Controls can be renamed at any time using the **Rename** option in the **Manage Picture Control** menu.

### **Manage Picture Control > Delete**

The **Delete** option in the **Manage Picture Control** menu can be used to delete selected custom Picture Controls when they are no longer needed.

### **The Original Picture Control Icon**

The original preset Picture Control on which the custom Picture Control is based is indicated by an icon in the top right corner of the edit display.



Original Picture Control icon



## Sharing Custom Picture Controls

Custom Picture Controls created using the Picture Control Utility available with ViewNX 2 or optional software such as Capture NX 2 can be copied to a memory card and loaded into the camera, or custom Picture Controls created with the camera can be copied to the memory card to be used in other D610 cameras and software and then deleted when no longer needed.

To copy custom Picture Controls to or from the memory card, or to delete custom Picture Controls from the memory card, highlight **Load/save** in the **Manage Picture Control** menu and press **▶**. The following options will be displayed:



- **Copy to camera:** Copy custom Picture Controls from the memory card to custom Picture Controls C-1 through C-9 on the camera and name them as desired.
- **Delete from card:** Delete selected custom Picture Controls from the memory card. The confirmation dialog shown at right will be displayed before a Picture Control is deleted; to delete the selected Picture Control, highlight **Yes** and press **OK**.
- **Copy to card:** Copy a custom Picture Control (C-1 through C-9) from the camera to a selected destination (1 through 99) on the memory card.



### Saving Custom Picture Controls

Up to 99 custom Picture Controls can be stored on the memory card at any one time. The memory card can only be used to store user-created custom Picture Controls. The preset Picture Controls supplied with the camera (□ 129) can not be copied to the memory card, renamed, or deleted.

The options in the **Manage Picture Control** menu apply only to the memory card in Slot 1. Custom Picture Controls can not be deleted from or copied to or from the card in Slot 2.

# Preserving Detail in Highlights and Shadows

## Active D-Lighting

*(P, S, A, and M Modes Only)*

Active D-Lighting preserves details in highlights and shadows, creating photographs with natural contrast. Use for high contrast scenes, for example when photographing brightly lit outdoor scenery through a door or window or taking pictures of shaded subjects on a sunny day. It is most effective when used with matrix metering (☐ 109).



*Active D-Lighting off*



*Active D-Lighting:  AA Auto*



### **“Active D-Lighting” Versus “D-Lighting”**

The **Active D-Lighting** option in the shooting menu adjusts exposure before shooting to optimize the dynamic range, while the **D-Lighting** option in the retouch menu optimizes dynamic range in images after shooting.

To use Active D-Lighting:

## 1 Select **Active D-Lighting** in the shooting menu.

To display the menus, press the **MENU** button. Highlight **Active D-Lighting** in the shooting menu and press ►.

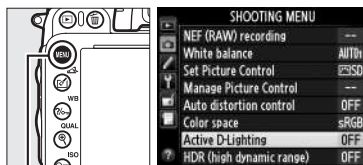

MENU button

## 2 Choose an option.

Highlight the desired option and press **OK**. If **暗A Auto** is selected, the camera will automatically adjust Active D-Lighting according to shooting conditions (in mode **M**, however, **暗A Auto** is equivalent to **暗N Normal**).



### ✔ **Active D-Lighting**

Active D-Lighting can not be used with movies. Noise (randomly-spaced bright pixels, fog, or lines) may appear in photographs taken with Active D-Lighting. Uneven shading may be visible with some subjects. Active D-Lighting can not be used at ISO sensitivities of Hi 0.3 or above.

### ✍ **See Also**

When **ADL bracketing** is selected for Custom Setting e6 (**Auto bracketing set**, 241), the camera varies Active D-Lighting over a series of shots (158). For information on using the **Fn** button and main command dial to select an Active D-Lighting option, see page 242.



# High Dynamic Range (HDR)

Used with high-contrast subjects, High Dynamic Range (HDR) preserves details in highlights and shadows by combining two shots taken at different exposures. HDR is most effective when used with matrix metering (□ 109; with other metering methods and a non-CPU lens, an exposure differential of **Auto** is equivalent to about 2 EV). It can not be used to record NEF (RAW) images. Movie recording (□ 57), flash lighting, bracketing (□ 153), multiple exposure (□ 160), and time-lapse photography (□ 168) can not be used while HDR is in effect and a shutter speed of **bulb** is not available.



- 1 Select HDR (high dynamic range).**  
Press the **MENU** button to display the menus. Highlight **HDR (high dynamic range)** in the shooting menu and press **▶**.

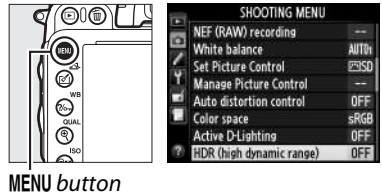

## 2 Select a mode.

Highlight **HDR mode** and press ►.



Highlight one of the following and press OK.

- To take a series of HDR photographs, select **ON/ On (series)**. HDR shooting will continue until you select **Off** for **HDR mode**.
- To take one HDR photograph, select **On (single photo)**. Normal shooting will resume automatically after you have created a single HDR photograph.
- To exit without creating additional HDR photographs, select **Off**.

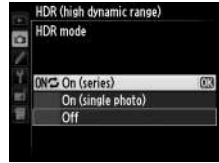

If **On (series)** or **On (single photo)** is selected, a **HDR** icon will be displayed in the control panel.

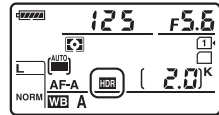

## 3 Choose the exposure differential.

To choose the difference in exposure between the two shots, highlight **Exposure differential** and press ►.

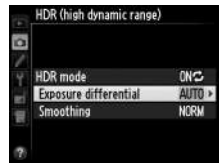

The options shown at right will be displayed. Highlight an option and press OK. Choose higher values for high-contrast subjects, but note that choosing a value higher than required may not produce the desired results; if **Auto** is selected, the camera will automatically adjust exposure to suit the scene.

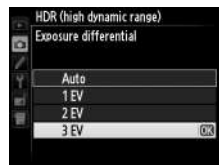

## 4 Choose the amount of smoothing.

To choose how much the boundaries between the two images are smoothed, highlight **Smoothing** and press ►.



The options shown at right will be displayed. Highlight an option and press **OK**. Higher values produce a smoother composite image. Uneven shading may be visible with some subjects.



## 5 Frame a photograph, focus, and shoot.

The camera takes two exposures when the shutter-release button is pressed all the way down. **Job HDR** will be displayed in the control panel and **Job Hdr** in the viewfinder while the images are combined; no photographs can be taken until recording is complete. Regardless of the option currently selected for release mode, only one photograph will be taken each time the shutter-release button is pressed.

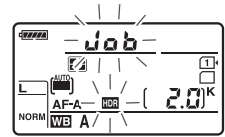

Control panel



Viewfinder

If **On (series)** is selected, HDR will only turn off when **Off** is selected for **HDR mode**; if **On (single photo)** is selected, HDR turns off automatically after the photograph is taken. The **HDR** icon clears from the display when HDR shooting ends.

### ✓ Framing HDR Photographs

The edges of the image will be cropped out. The desired results may not be achieved if the camera or subject moves during shooting. Use of a tripod is recommended. Depending on the scene, shadows may appear around bright objects or halos may appear around dark objects; this effect can be reduced by adjusting the amount of smoothing.

### ✍ Interval Timer Photography

If **On (series)** is selected for **HDR mode** before interval timer shooting begins, the camera will continue to shoot HDR photographs at the selected interval (if **On (single photo)** is selected, interval timer shooting will end after a single shot).











# Flash Photography

## Using the Built-in Flash

The built-in flash has a Guide Number (GN) 12/39 (m/ft, ISO 100, 20 °C/68 °F) and provides coverage for the angle of view of 24 mm lens, or a 16 mm lens in DX format. It can be used not only when natural lighting is inadequate but to fill in shadows and backlit subjects or to add a catch light to the subject's eyes.

■ **Using the Built-in Flash:** , , , , , , and  Modes

**1** Choose a flash mode ( 144).

**2** Take pictures.

The flash will pop up as required when the shutter-release button is pressed halfway, and fire when a photograph is taken. *If the flash does not pop up automatically, DO NOT attempt to raise it by hand. Failure to observe this precaution could damage the flash.*

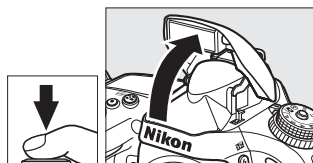

■ **Using the Built-in Flash: P, S, A, M, and  Modes**

**1** Raise the flash.



Press the  () button to raise the flash.

**2** Choose a flash mode (P, S, A, and M modes only;  144).

**3** Take pictures.

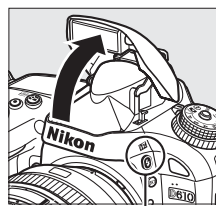
The flash will fire whenever a picture is taken.



 () button

### Metering

Select matrix or center-weighted metering to activate i-TTL balanced fill-flash for digital SLR. Standard i-TTL flash for digital SLR is activated automatically when spot metering is selected.

# Flash Mode

The flash modes available vary with shooting mode:

AUTO,  ,  ,  ,  ,  ,			
<b>Auto</b>	<b>Auto + slow sync + red-eye reduction</b>	<b>Fill flash</b>	
<b>Auto + red-eye reduction</b>	<b>Auto + slow sync</b>		
<b>Off</b>	<b>Off</b>		
P, A		S, M	
<b>Fill flash</b>	<b>Fill flash</b>		
<b>Red-eye reduction</b>	<b>Red-eye reduction</b>		
<b>Slow sync + red-eye reduction</b>	<b>Rear-curtain sync</b>		
<b>Slow sync</b>			
<b>Rear curtain + slow sync*</b>			

\* **SLOW** is displayed when setting is complete.

To choose a flash mode, press the () button and rotate the main command dial until the desired setting is displayed in the control panel.

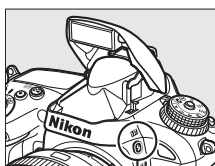

() button

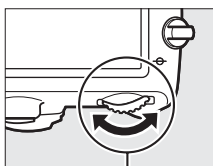

Main command dial

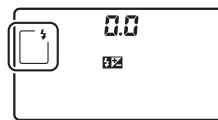

Control panel

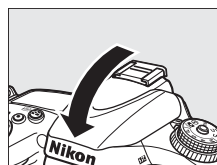

## Lowering the Built-in Flash

To save power when the flash is not in use, press it gently downward until the latch clicks into place.





## Default Flash Modes

Default flash modes are shown below.

Mode	Default	Mode	Default
	Auto		Auto+slow sync
	Auto+red-eye reduction	¶1, P, S, A, M	Fill flash

## Flash Modes

The flash modes listed on the previous page may combine one or more of the following settings, as shown by the flash mode icon:

- **AUTO (auto flash):** When lighting is poor or subject is back lit, flash pops up automatically when shutter-release button is pressed halfway and fires as required.
- ** (red-eye reduction):** Use for portraits. Red-eye reduction lamp lights before flash fires, reducing “red-eye.”
- ** (off):** Flash does not fire even when lighting is poor or subject is back-lit.
- **SLOW (slow sync):** Shutter speed slows automatically to capture background lighting at night or under low light. Use to include background lighting in portraits.
- **REAR (rear-curtain sync):** Flash fires just before shutter closes, creating a stream of light behind moving light sources (below at right). If this icon is not displayed, flash will fire as the shutter opens (front-curtain sync; the effect this produces with moving light sources is shown below at left).





*Front-curtain sync*



*Rear-curtain sync*

## The Built-in Flash

Use with lenses with focal lengths in FX format of 24–300 mm (16–300 mm in DX format;  288). Remove lens hoods to prevent shadows. The flash has a minimum range of 0.6 m (2 ft) and can not be used in the macro range of zoom lenses with a macro function. i-TTL flash control can be used at ISO sensitivities between 100 and 6400. At values over 6400, the desired results may not be achieved at some ranges or aperture settings.

If the flash fires in continuous release mode ( 83), only one picture will be taken each time the shutter-release button is pressed.

The shutter release may be briefly disabled to protect the flash after it has been used for several consecutive shots. The flash can be used again after a short pause.



## Shutter Speeds Available with the Built-in Flash

The following shutter speeds are available with the built-in flash.

Mode	Shutter speed	Mode	Shutter speed
AUTO, P*, A*, S, B, L, M, W	1/200–1/60 s	S*	1/200–30 s
M, H	1/200–1/125 s	M*	1/200–30 s, B, L, M
Q	1/200–1 s		











\* Speeds as fast as 1/4,000 s are available with optional SB-910, SB-900, SB-800, SB-700, and SB-600 flash units when **1/250 s (Auto FP)** or **1/200 s (Auto FP)** is selected for Custom Setting e1 (**Flash sync speed**,  234). When **1/250 s (Auto FP)** is selected, shutter speeds as fast as 1/250 s are available with the built-in flash.

## Flash Control Mode

The camera supports the following i-TTL flash control modes:

- **i-TTL balanced fill-flash for digital SLR:** Flash emits series of nearly invisible preflashes (monitor preflashes) immediately before main flash. Preflashes reflected from objects in all areas of frame are picked up by 2,016-pixel RGB sensor and are analyzed in combination with range information from matrix metering system to adjust flash output for natural balance between main subject and ambient background lighting. If type G, E, or D lens is used, distance information is included when calculating flash output. Precision of calculation can be increased for non-CPU lenses by providing lens data (focal length and maximum aperture; see  172). Not available when spot metering is used.
- **Standard i-TTL flash for digital SLR:** Flash output adjusted to bring lighting in frame to standard level; brightness of background is not taken into account. Recommended for shots in which main subject is emphasized at expense of background details, or when exposure compensation is used. Standard i-TTL flash for digital SLR is activated automatically when spot metering is selected.

The flash control mode for the built-in flash can be selected using Custom Setting e3 (**Flash cntrl for built-in flash**,  236). The information display shows the flash control mode for the built-in flash as follows:

	Flash sync	Auto FP (  234)
i-TTL	 	—
Manual	 	—
Repeating flash	 	—
Commander mode	 	



## Aperture, Sensitivity, and Flash Range

Flash range varies with sensitivity (ISO equivalency) and aperture.

Aperture at ISO equivalent of							Range	
100	200	400	800	1600	3200	6400	m	ft
1.4	2	2.8	4	5.6	8	11	0.7–8.5	2ft 4in.–27ft 11in.
2	2.8	4	5.6	8	11	16	0.6–6.0	2ft–19ft 8in.
2.8	4	5.6	8	11	16	22	0.6–4.2	2ft–13ft 9in.
4	5.6	8	11	16	22	32	0.6–3.0	2ft–9ft 10in.
5.6	8	11	16	22	32	—	0.6–2.1	2ft–6ft 11in.
8	11	16	22	32	—	—	0.6–1.5	2ft–4ft 11in.
11	16	22	32	—	—	—	0.6–1.1	2ft–3ft 7in.
16	22	32	—	—	—	—	0.6–0.8	2ft–2ft 7in.

The built-in flash has a minimum range of 0.6 m (2 ft).



In mode **P**, the maximum aperture (minimum f-number) is limited according to ISO sensitivity, as shown below:

Maximum aperture at ISO equivalent of:						
100	200	400	800	1600	3200	6400
2.8	3.5	4	5	5.6	7.1	8

If the maximum aperture of the lens is smaller than given above, the maximum value for aperture will be the maximum aperture of the lens.

## See Also

See page 149 for information on locking flash value (FV) for a metered subject before recomposing a photograph.

For information on auto FP high-speed sync and choosing a flash sync speed, see Custom Setting e1 (**Flash sync speed**,  234). For information on choosing the slowest shutter speed available when using the flash, see Custom Setting e2 (**Flash shutter speed**,  235). For information on flash control and using the built-in flash in commander mode, see Custom Setting e3 (**Flash cntrl for built-in flash**,  236).

See page 292 for information on using optional flash units.





# Flash Compensation

(P, S, A, and M Modes Only)

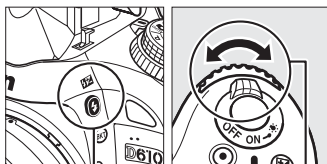

Flash compensation is used to alter flash output by from  $-3$  EV to  $+1$  EV in increments of  $\frac{1}{3}$  EV, changing the brightness of the main subject relative to the background. Flash output can be increased to make the main subject appear brighter, or reduced to prevent unwanted highlights or reflections.

Press the  button and rotate the sub-command dial until the desired value is displayed in the control panel. In general, choose positive values to make the main subject brighter, negative values to make it darker.



 button

Sub-command dial

At values other than  $\pm 0.0$ , a  icon will be displayed in the control panel and viewfinder after you release the  button. The current value for flash compensation can be confirmed by pressing the  button.

Normal flash output can be restored by setting flash compensation to  $\pm 0.0$ . Flash compensation is not reset when the camera is turned off.

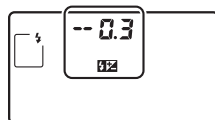

$\pm 0.0$  EV

 button pressed)



$-0.3$  EV





$+1.0$  EV

## Optional Flash Units

Flash compensation is also available with optional flash units that support the Nikon Creative Lighting System (CLS). The SB-910, SB-900, SB-800, SB-700, and SB-600 also allow flash compensation to be set using the controls on the flash unit; the value selected with the flash unit is added to the value selected with the camera.

## See Also

For information on choosing the size of the increments available for flash compensation, see Custom Setting b2 (**EV steps for exposure cntrl**,  224). For information on choosing how flash and exposure compensation combine, see Custom Setting e4 (**Exposure comp. for flash**,  240). For information on automatically varying flash level over a series of shots, see page 153.

# FV Lock

This feature is used to lock flash output, allowing photographs to be recomposed without changing the flash level and ensuring that flash output is appropriate to the subject even when the subject is not positioned in the center of the frame. Flash output is adjusted automatically for any changes in ISO sensitivity and aperture.







To use FV lock:

## 1 Assign FV lock to the Fn button.

Select **FV lock** for Custom Setting f2 (**Assign Fn button**,  242).



## 2 Raise the flash.

In **P**, **S**, **A**, **M**, and **Hi** modes, the flash can be raised by pressing the  button. In **AUTO**, , , , , , and  modes, the flash will pop up automatically when required.

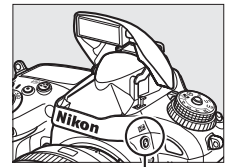



 button

## 3 Focus.

Position the subject in the center of the frame and press the shutter-release button halfway to focus.



## 4 Lock flash level.

After confirming that the flash ready indicator () is displayed in the viewfinder, press the **Fn** button. The flash will emit a monitor preflash to determine the appropriate flash level. Flash output will be locked at this level and FV lock icons () will appear in the viewfinder.

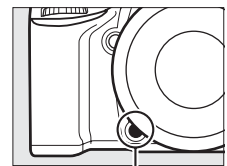

**Fn** button



## 5 Recompose the photograph.



## 6 Take the photograph.

Press the shutter-release button the rest of the way down to shoot. If desired, additional pictures can be taken without releasing FV lock.

## 7 Release FV lock.

Press the **Fn** button to release FV lock. Confirm that the FV lock icon (AF-L) is no longer displayed in the viewfinder.

### ✓ Using FV Lock with the Built-in Flash

FV lock is only available with the built-in flash when TTL is selected for Custom Setting e3 (**Flash cntrl for built-in flash**, □ 236).

### ✍ Using FV Lock with Optional Flash Units

FV lock is also available with optional flash units in TTL and (where supported) monitor pre-flash AA and monitor pre-flash A flash control modes. Note that when commander mode is selected for Custom Setting e3 (**Flash cntrl for built-in flash**, □ 236), you will need to set the flash control mode for the master or at least one remote group to TTL or AA.

### ✍ Metering

The metering areas for FV lock when using optional flash unit are as follows:

Flash unit	Flash mode	Metered area
Stand-alone flash unit	i-TTL	5-mm circle in center of frame
	AA	Area metered by flash exposure meter
Used with other flash units (Advanced Wireless Lighting)	i-TTL	Entire frame
	AA	Area metered by flash exposure meter
	A (master flash)	



### ✍ See Also

For information on using the depth-of-field preview or  $\overline{\text{AE-L}}$  **AE-L/AF-L** button for FV lock, see Custom Setting f3 (**Assign preview button**, □ 244) or Custom Setting f4 (**Assign AE-L/AF-L button**, □ 244).









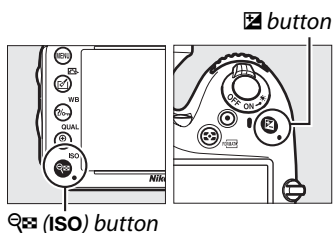

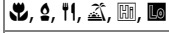















# Other Shooting Options

## Two-Button Reset: Restoring Default Settings

The camera settings listed below can be restored to default values by holding the  (ISO) and  buttons down together for more than two seconds (these buttons are marked by a green dot). The control panel turns off briefly while settings are reset.



Option	Default	
Image quality	JPEG normal	93
Image size	Large	95
White balance	Auto > Normal	115
Fine tuning	A-B: 0, G-M: 0	117
HDR (high dynamic range)	Off <sup>1</sup>	139
ISO sensitivity settings		
ISO sensitivity		
Auto and scene modes <b>P, S, A, M</b>	AUTO 100	105
Auto ISO sensitivity control	Off	107
Interval timer shooting	Off <sup>2</sup>	164
Autofocus (viewfinder)		
Autofocus mode	AF-A	97
AF-area mode		
	Single-point AF	99
	39-point dynamic-area AF	
 AUTO,  ,  ,  ,  ,  ,  ,  ,  ,  ,  ,  ,  ,  ,  , P, S, A, M	Auto-area AF	

Option	Default	
Autofocus (live view/movie)		
Autofocus mode	AF-S	51
AF-area mode		
 P, S, A, M	Wide-area AF	52
	Normal-area AF	
	Face-priority AF	
Focus point <sup>3</sup>	Center	101
Metering	Matrix	109
AE lock hold	Off	102, 110
Bracketing	Off	153
Picture Control settings <sup>4</sup>	Unmodified	129
Flash compensation	Off	148
Exposure compensation	Off	112
Exposure delay mode	Off	231
Flash mode		
	Auto	144
	Auto+red-eye reduction	
	Auto+slow sync	
⌈, P, S, A, M	Fill flash	
FV lock	Off	149
Multiple exposure	Off <sup>5</sup>	160
Flexible program	Off	75
+ NEF (RAW)	Off	242

1 Exposure differential and smoothing are not reset.

2 If interval timer shooting is currently in progress, shooting will end. Starting time, shooting interval, and number of intervals and shots are not reset.

3 Focus point not displayed if auto-area AF is selected for AF-area mode.

4 Current Picture Control only.

5 If multiple exposure is currently in progress, shooting will end and multiple exposure will be created from exposures recorded to that point. Gain and number of shots are not reset.



Bracketing automatically varies exposure, flash level, Active D-Lighting (ADL), or white balance slightly with each shot, “bracketing” the current value. Choose in situations in which it is difficult to set exposure, flash level (i-TTL and, where supported, auto aperture flash control modes only; see pages 146, 236, and 294), white balance, or Active D-Lighting and there is not time to check results and adjust settings with each shot, or to experiment with different settings for the same subject.

## ■ Exposure and Flash Bracketing

To vary exposure and/or flash level over a series of photographs:

### 1 Select flash or exposure bracketing for Custom Setting e6 (Auto bracketing set) in the Custom Settings menu.

To display the menus, press the MENU button. Select Custom Setting e6 (Auto bracketing set) in the Custom Settings menu, highlight an option, and press **OK**. Choose **AE & flash** to vary both exposure and flash level, **AE only** to vary only exposure, or **Flash only** to vary only flash level.

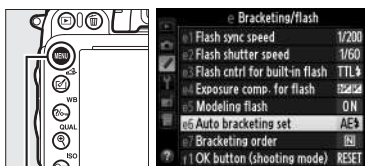

MENU button

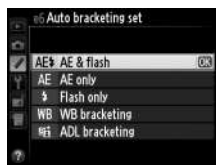

### 2 Choose the number of shots.

Pressing the **BKT** button, rotate the main command dial to choose the number of shots in the bracketing sequence and the order in which they will be taken.

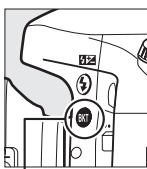

BKT button

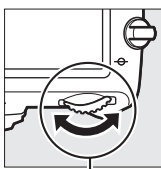

Main command dial

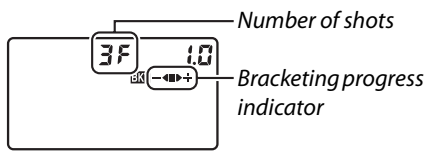

Control panel

No. of shots	Bracketing progress indicator	Bracketing order
3F	←■▶+	Normal exposure, underexposure, overexposure
+2F	■▶+	Normal exposure, overexposure
--2F	←■	Normal exposure, underexposure

BKT will be displayed in the viewfinder (see right); the control panel will show **BKT**.



### 3 Select a bracketing increment.

Pressing the **BKT** button and rotate the sub-command dial to choose a bracketing increment.

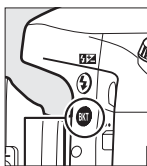

BKT button

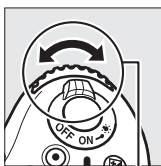

Sub-command dial

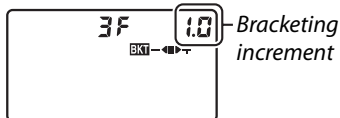

Control panel

1.0  
Bracketing increment

#### See Also

For information on choosing the size of the increment, see Custom Setting b2 (**EV steps for exposure ctrl**, □ 224). For information on choosing the order in which bracketing is performed, see Custom Setting e7 (**Bracketing order**, □ 241).

### 4 Frame a photograph, focus, and shoot.

The camera will vary exposure and/or flash level shot-by-shot according to the bracketing program selected.



Modifications to exposure are added to those made with exposure compensation (□ 112), making it possible to achieve exposure compensation values of more than 5 EV.

While bracketing is in effect, a bracketing progress indicator will be displayed in the control panel. A segment will disappear from the indicator after each shot: the ■ segment when the unmodified shot is taken, the ◀ segment when the shot with the negative increment is taken, and the ▶+ segment when the shot with the positive increment is taken.

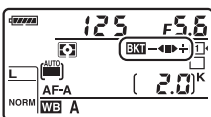

Exposure modified by:  
0 EV (■)

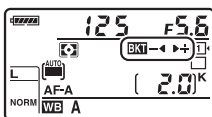

Exposure modified by:  
-1 EV (◀)

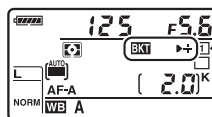

Exposure modified by:  
+1 EV (▶+)

To cancel bracketing, press the **BKT** button and rotate the main command dial until the bracketing progress indicator and **BKT** icon are no longer displayed.



### **Exposure and Flash Bracketing**

In continuous low speed, continuous high speed, and Qc (quiet continuous) release modes, shooting will pause after the number of shots specified in the bracketing program have been taken. Shooting will resume the next time the shutter-release button is pressed. In self-timer mode, the camera will take the number of shots selected in Step 2 on page 153 each time the shutter-release button is pressed, regardless of the option selected for Custom Setting c3 (**Self-timer**) > **Number of shots** (□ 227); the interval between shots is however controlled by Custom Setting c3 (**Self-timer**) > **Interval between shots**. In other modes, one shot will be taken each time the shutter-release button is pressed.

If the memory card fills before all shots in the sequence have been taken, shooting can be resumed from the next shot in the sequence after the memory card has been replaced or shots have been deleted to make room on the memory card. If the camera is turned off before all shots in the sequence have been taken, bracketing will resume from the next shot in the sequence when the camera is turned on.

### **Exposure Bracketing**

The camera modifies exposure by varying shutter speed and aperture (mode **P**), aperture (mode **S**), or shutter speed (modes **A** and **M**). If **On** is selected for **ISO sensitivity settings** > **Auto ISO sensitivity control** (□ 107) in modes **P**, **S**, and **A**, the camera will automatically vary ISO sensitivity for optimum exposure when the limits of the camera exposure system are exceeded; in mode **M**, the camera will first use auto ISO sensitivity control to bring exposure as close as possible to the optimum and then bracket this exposure by varying shutter speed.



## ■ White Balance Bracketing

The camera creates multiple copies of each photograph, each with a different white balance. For more information on white balance, see page 115.

### 1 Select white balance bracketing.

Choose **WB bracketing** for Custom Setting e6 **Auto bracketing set**.

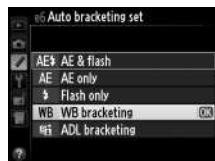

### 2 Choose the number of shots.

Pressing the **BKT** button, rotate the main command dial to choose the number of shots in the bracketing sequence and the order in which they will be taken.

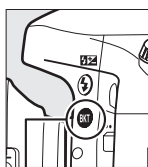

BKT button



Main command dial

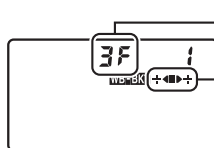

Number of shots

Bracketing progress indicator

**BKT** will be displayed in the viewfinder (see right); the control panel will show **WB-BKT**.



### 3 Select a white balance increment.

Pressing the **BKT** button, rotate the sub-command dial to choose from increments of 1 (5 mired; □ 119), 2 (10 mired), or 3 (15 mired). The **B** value indicates the amount of blue, the **A** value the amount of amber (□ 117).

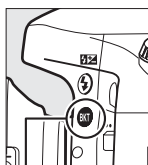

BKT button

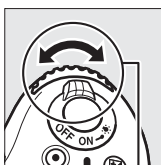

Sub-command dial

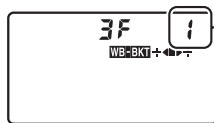

White balance increment

The bracketing programs with an increment of 1 are listed below.

Control panel	Bracketing progress indicator	No. of shots	Increment	Bracketing order
b2F 1	+< >	2	1B	0 / 1 B
A2F 1	> +	2	1A	0 / 1 A
3F 1	+< >+	3	1A, 1B	0 / 1 A / 1 B

## 4 Frame a photograph, focus, and shoot.

Each shot will be processed to create the number of copies specified in the bracketing program, and each copy will have a different white balance. Modifications to white balance are added to the white balance adjustment made with white balance fine-tuning.



If the number of shots in the bracketing program is greater than the number of exposures remaining, **FuLL** and the icon for the affected card will flash in the control panel, a flashing **FuL** icon will appear in the viewfinder as shown at right, and the shutter release will be disabled. Shooting can begin when a new memory card is inserted.

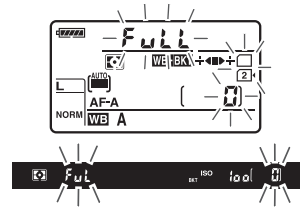

To cancel bracketing, press the **BKT** button and rotate the main command dial until the bracketing progress indicator and **WB-BKT** icon are no longer displayed.

### White Balance Bracketing

White balance bracketing is not available at an image quality of NEF (RAW). Selecting **NEF (RAW)**, **NEF (RAW)+JPEG fine**, **NEF (RAW)+JPEG normal**, or **NEF (RAW)+JPEG basic** cancels white balance bracketing.

White balance bracketing affects only color temperature (the amber-blue axis in the white balance fine-tuning display, [□ 117](#)). No adjustments are made on the green-magenta axis.

In self-timer mode ([□ 85](#)), the number of copies specified in the white-balance program will be created each time the shutter is released, regardless of the option selected for Custom Setting c3 (**Self-timer**) > **Number of shots** ([□ 227](#)).

If the camera is turned off while the memory card access lamp is lit, the camera will power off only after all photographs in the sequence have been recorded.



## ■ ■ ADL Bracketing

The camera varies Active D-Lighting over a series of exposures. For more information on Active D-Lighting, see page 137.

### 1 Select ADL bracketing.

Choose **ADL bracketing** for Custom Setting e6 **Auto bracketing set**.

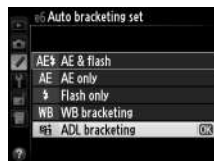

### 2 Choose the number of shots.

Pressing the **BKT** button, rotate the main command dial to choose the number of shots in the bracketing sequence. Choose two shots to take one photograph with Active D-Lighting off and another at the value currently selected for **Active D-Lighting** in the shooting menu (if Active D-Lighting is off, the second shot will be taken with Active D-Lighting set to **Auto**). Choose three shots to take a series of photographs with Active D-Lighting set to **Off, Normal, and High**.

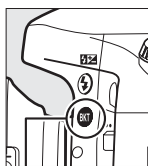

BKT button

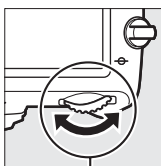

Main command dial

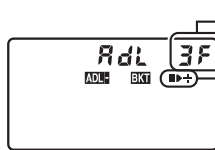

Control panel

Number of shots

Bracketing progress indicator

BKT will be displayed in the viewfinder (see right); the control panel will show **ADL-BKT**.



### 3 Frame a photograph, focus, and shoot.

The camera will vary Active D-Lighting shot-by-shot according to the bracketing program selected. While bracketing is in effect, a bracketing progress indicator will be displayed in the control panel. A segment will disappear from the indicator after each shot: the ■ segment when the first shot is taken, the ► segment when the second shot is taken, and the + segment when the third shot (if applicable) is taken.

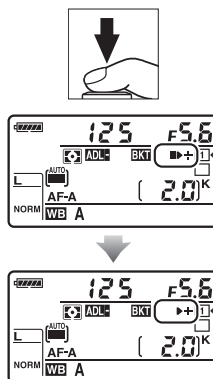

To cancel bracketing, press the **BKT** button and rotate the main command dial until the bracketing progress indicator and **ADL-BKT** icon are no longer displayed.

#### **ADL Bracketing**

In continuous low speed, continuous high speed, and Qc (quiet continuous) release modes, shooting will pause after the number of shots specified in the bracketing program have been taken. Shooting will resume the next time the shutter-release button is pressed. In self-timer mode, the camera will take the number of shots selected in Step 2 on page 158 each time the shutter-release button is pressed, regardless of the option selected for Custom Setting c3 (**Self-timer**) > **Number of shots** (□ 227); the interval between shots is however controlled by Custom Setting c3 (**Self-timer**) > **Interval between shots**. In other modes, one shot will be taken each time the shutter-release button is pressed.

If the memory card fills before all shots in the sequence have been taken, shooting can be resumed from the next shot in the sequence after the memory card has been replaced or shots have been deleted to make room on the memory card. If the camera is turned off before all shots in the sequence have been taken, bracketing will resume from the next shot in the sequence when the camera is turned on.



# Multiple Exposure

(P, S, A, and M Modes Only)

Follow the steps below to record a series of two or three exposures in a single photograph. Multiple exposures can make use of RAW data from the camera image sensor to produce colors noticeably superior to those in software-generated photographic overlays.

## ■ Creating a Multiple Exposure

Multiple exposures can not be recorded in live view. Exit live view before proceeding. Note that at default settings, shooting will end and a multiple exposure will be recorded automatically if no operations are performed for 30 s.

### ✎ Extended Recording Times

For an interval between exposures of more than 30 s, extend the meter-off delay using Custom Setting c2 (**Standby timer**,  227). The maximum interval between exposures is 30 s longer than the option selected for Custom Setting c2. If the monitor has turned off during playback or menu operations, shooting will end 30 s after the exposure meters turn off and a multiple exposure will be created from the exposures that have been recorded to that point.

## 1 Select Multiple exposure in the shooting menu.

Press the **MENU** button to display the menus. Highlight **Multiple exposure** in the shooting menu and press **▶**.



MENU button



## 2 Select a mode.

Highlight **Multiple exposure mode** and press ►.

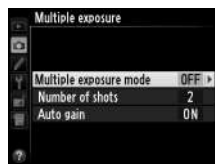

Highlight one of the following and press OK.

- To take a series of multiple exposures, select **ON (series)**. Multiple exposure shooting will continue until you select **Off** for **Multiple exposure mode**.
- To take one multiple exposure, select **On (single photo)**. Normal shooting will resume automatically after you have created a single multiple exposure.
- To exit without creating additional multiple exposures, select **Off**.

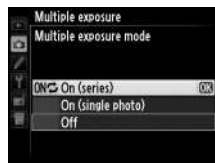

If **On (series)** or **On (single photo)** is selected, a  icon will be displayed in the control panel.

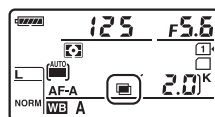

## 3 Choose the number of shots.

Highlight **Number of shots** and press ►.

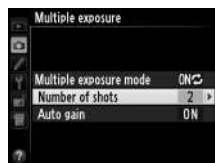

Press ▲ or ▼ to choose the number of exposures that will be combined to form a single photograph and press OK.

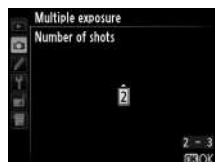

## 4 Choose the amount of gain.

Highlight **Auto gain** and press **▶**.



The following options will be displayed.

Highlight an option and press **OK**.

- **On:** Gain is adjusted according to number of exposures actually recorded (gain for each exposure is set to  $1/2$  for 2 exposures,  $1/3$  for 3 exposures, etc.).

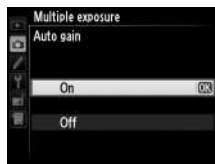

- **Off:** Gain is not adjusted when recording multiple exposure. Recommended if background is dark.

## 5 Frame a photograph, focus, and shoot.

In continuous high-speed, continuous low-speed, and Qc (quiet continuous) release modes (□ 83), the camera records all

exposures in a single burst. If **On (series)** is selected, the camera will continue to record multiple exposures while the shutter-release button is pressed; if **On (single photo)** is selected, multiple exposure shooting will end after the first photograph. In self-timer mode, the camera will automatically record the number of exposures selected in Step 3 on page 161, regardless of the option selected for Custom Setting c3 (**Self-timer**) > **Number of shots** (□ 227); the interval between shots is however controlled by Custom Setting c3 (**Self-timer**) > **Interval between shots**. In other release modes, one photograph will be taken each time the shutter-release button is pressed; continue shooting until all exposures have been recorded (for information on interrupting a multiple exposure before all photographs are recorded, see page 163).



The  icon will flash until shooting ends. If

**On (series)** is selected, multiple exposure shooting will only end when **Off** is selected for multiple exposure mode; if **On (single photo)** is selected, multiple exposure

shooting ends automatically when the multiple exposure is complete. The  icon clears from the display when multiple exposure shooting ends.

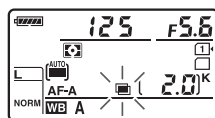



## ■ Interrupting Multiple Exposures

To interrupt a multiple exposure before the specified number of exposures have been taken, select **Off** for multiple exposure mode. If shooting ends before the specified number of exposures have been taken, a multiple exposure will be created from the exposures that have been recorded to that point. If

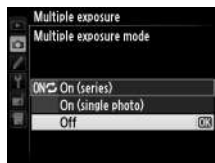

**Auto gain** is on, gain will be adjusted to reflect the number of exposures actually recorded. Note that shooting will end automatically if:

- A two-button reset is performed (□ 151)
- The camera is turned off
- The battery is exhausted
- Pictures are deleted

### ✓ Multiple Exposures

Do not remove or replace the memory card while recording a multiple exposure.

Multiple exposures can not be recorded in live view. Taking photographs in live view resets **Multiple exposure mode** to **Off**.

Noise (randomly-spaced bright pixels, fog, or lines) may appear in photographs taken with **Off** selected for auto gain (□ 162).

The information listed in the playback photo information display (including metering, exposure, shooting mode, focal length, date of recording and camera orientation) is for the first shot in the multiple exposure.

### ✍ Interval Timer Photography

If interval timer photography is activated before the first exposure is taken, the camera will record exposures at the selected interval until the number of exposures specified in the multiple exposure menu have been taken (the number of shots listed in the interval timer shooting menu is ignored). These exposures will then be recorded as a single photograph and interval timer shooting will end (if **On (single photo)** is selected for multiple exposure mode, multiple exposure shooting will also end automatically).

### ✍ Other Settings

While a multiple exposure is being shot, memory cards can not be formatted and some menu items are grayed out and can not be changed.



# Interval Timer Photography

The camera is equipped to take photographs automatically at preset intervals.

## ✔ Before Shooting

Do not select self-timer (☺), remote (📡), or **MUP** release mode when using the interval timer. Before beginning interval timer photography, take a test shot at current settings and view the results in the monitor.

Before choosing a starting time, select **Time zone and date** in the setup menu and make sure that the camera clock is set to the correct time and date (📅 253).

Use of a tripod is recommended. Mount the camera on a tripod before shooting begins. To ensure that shooting is not interrupted, be sure the camera EN-EL15 battery is fully charged. If in doubt, charge the battery before use or use an EH-5b AC adapter and EP-5B power connector (available separately).

## 1 Select Interval timer shooting in the shooting menu.

Press the **MENU** button to display the menus. Highlight **Interval timer shooting** in the shooting menu and press ►.

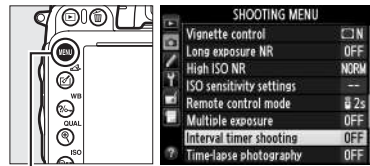

MENU button

## 2 Choose a starting time.

Choose from the following starting triggers.

- **To start shooting immediately**, highlight **Now** and press ►. Shooting begins about 3 s after settings are completed; proceed to Step 3.
- **To choose a starting time**, highlight **Start time** and press ► to display the start time options shown at right. Press ◀ or ▶ to highlight hours or minutes and press ▲ or ▼ to change. Press ► to continue.

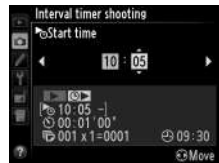
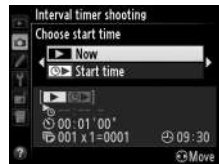

## 3 Choose the interval.

Press ◀ or ▶ to highlight hours, minutes, or seconds; press ▲ or ▼ to change. Choose an interval longer than the time needed to take the number of shots selected in Step 4. If the interval is too short, the number of photos taken may be less than the total listed in Step 4 (the number of intervals multiplied by the number of shots per interval). Press ► to continue.



#### 4 Choose the number of intervals and number of shots per interval.

Press ◀ or ▶ to highlight number of intervals or number of shots; press ▲ or ▼ to change. Press ▶ to continue.

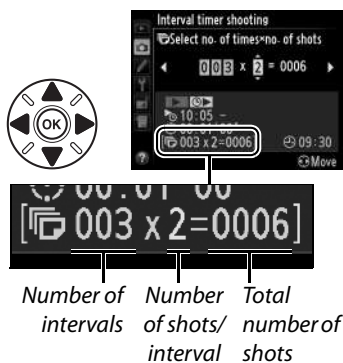

#### 5 Start shooting.

Highlight **On** and press  $\odot$  (to return to the shooting menu without starting the interval timer, highlight **Off** and press  $\odot$ ). The first series of shots will be taken at the specified starting time, or after about 3 s if **Now** was selected for **Choose start time** in Step 2. Shooting will continue at the selected interval until all shots have been taken. Note that because the shutter speed, frame rate, and time needed to record images may vary from one interval to the next, the time between the end of one interval and the beginning of the next may vary. If shooting can not proceed at current settings (for example, if a shutter speed of  $\frac{1}{200}$  is currently selected in manual exposure mode or the start time is in less than a minute), a warning will be displayed in the monitor.

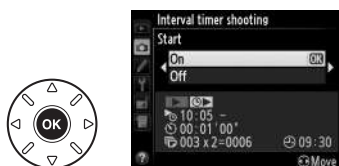

#### ✓ Out of Memory





If the memory card is full, the interval timer will remain active but no pictures will be taken. Resume shooting (167) after deleting some pictures or turning the camera off and inserting another memory card.

#### ✍ Cover the Viewfinder

To prevent light entering via the viewfinder interfering with exposure, remove the rubber eyecup and cover the viewfinder with the supplied DK-5 eyepiece cap (86).



## Interval Timer Photography

Interval timer photography can not be combined with long time-exposures (bulb photography,  79) or live view ( 49) or time-lapse ( 168) photography and is not available in movie live view ( 57) or when **Record movies** is selected for Custom Setting g4 (**Assign shutter button**,  248).

## Release Mode

Regardless of the release mode selected, the camera will take the specified number of shots at each interval. Photographs will be taken at up to 6 shots per second in **C** (continuous high-speed mode) or at up to 3 shots per second in **Qc** mode. In **S** (single frame) and **C** (continuous low-speed) modes, photographs will be taken at the rate chosen for Custom Setting d5 (**CL mode shooting speed**,  229). In modes **Q** and **Qc**, camera noise will be reduced.

## Bracketing

Adjust bracketing settings before starting interval timer photography. If exposure, flash, or ADL bracketing is active while interval timer photography is in effect, the camera will take the number of shots in the bracketing program at each interval, regardless of the number of shots specified in the interval timer menu. If white balance bracketing is active while interval timer photography is in effect, the camera will take one shot at each interval and process it to create the number of copies specified in the bracketing program.

## During Shooting

During interval timer photography, the **INTVL** icon in the control panel will flash. Immediately before the next shooting interval begins, the shutter speed display will show the number of intervals remaining, and the aperture display will show the number of shots remaining in the current interval. At other times, the number of intervals remaining and the number of shots in each interval can be viewed by pressing the shutter-release button halfway (once the button is released, the shutter speed and aperture will be displayed until the standby timer expires).

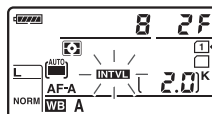

To view current interval timer settings, select **Interval timer shooting** between shots. While interval timer photography is in progress, the interval timer menu will show the starting time, the shooting interval, and the number of intervals and shots remaining. None of these items can be changed while interval timer photography is in progress.



Pictures can be played back and shooting and menu settings can be adjusted freely while interval timer photography is in progress. The monitor will turn off automatically about four seconds before each interval.

## ■ Pausing Interval Timer Photography

Interval timer photography can be paused by:

- Pressing the **OK** button between intervals
- Highlighting **Start > Pause** in the interval timer menu and pressing **OK**
- Turning the camera off and then on again (if desired, the memory card can be replaced while the camera is off)
- Selecting self-timer (☺), remote (☑), or **MUP** release mode

To resume shooting:

### 1 Choose a new starting time.

Choose a new starting time as described on page 164.

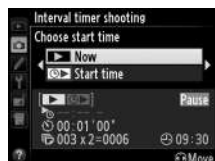

### 2 Resume shooting.

Highlight **Restart** and press **OK**. Note that if interval timer photography was paused during shooting, any shots remaining in the current interval will be canceled.

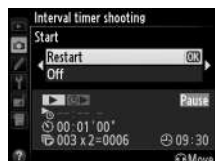

## ■ Interrupting Interval Timer Photography

Interval timer shooting will end automatically if the battery is exhausted. Interval timer photography can also be ended by:

- Selecting **Start > Off** in the interval timer menu
- Performing a two button reset (☐ 151)
- Selecting **Reset shooting menu** in the shooting menu (☐ 214)
- Changing bracketing settings (☐ 153)
- Terminating HDR (☐ 139) or multiple exposure shooting (☐ 163)

Normal shooting will resume when interval timer photography ends.

## ■ No Photograph

The camera will skip the current interval if any of the following situations persist for eight seconds or more after the interval was due to start: the photograph or photographs for the previous interval have yet to be taken, the memory buffer is full, or the camera is unable to focus in **AF-S** or when single-servo AF is selected in **AF-A** (note that the camera focuses again before each shot). Shooting will resume with the next interval.



# Time-Lapse Photography

The camera automatically takes photos at selected intervals to create a silent time-lapse movie using the options currently selected for **Movie settings** in the shooting menu (📖 65).

## 🔍 Before Shooting

Before beginning time-lapse photography, take a test shot at current settings (framing the photo in the viewfinder for an accurate exposure preview) and view the results in the monitor. To record changes in brightness, choose manual exposure (📖 78); for consistent coloration, choose a white balance setting other than auto (📖 115). We recommend that you briefly switch to movie live view and check the current image area crop in the monitor (📖 57); note, however, that time-lapse photography is not available in live view.

Use of a tripod is recommended. Mount the camera on a tripod before shooting begins. To ensure that shooting is not interrupted, use an optional EH-5b AC adapter and EP-5B power connector or a fully-charged EN-EL15 battery.

## 1 Select Time-lapse photography in the shooting menu.

Press the MENU button to display the menus. Highlight **Time-lapse photography** in the shooting menu and press ►.

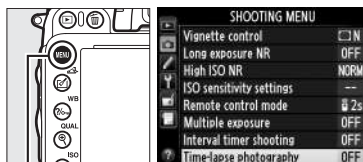

MENU button

## 2 Press ►.

Press ► to proceed to Step 3 and choose an interval and shooting time. To record a time-lapse movie using the default interval of 5 seconds and shooting time of 25 minutes, proceed to step 5.



## 3 Choose the interval.

Press ◀ or ▶ to highlight minutes or seconds; press ▲ or ▼ to change. Choose an interval longer than the slowest anticipated shutter speed. Press ► to continue.





#### 4 Select the shooting time.

Press ◀ or ▶ to highlight hours or minutes; press ▲ or ▼ to change. The maximum shooting time is 7 hours and 59 minutes. Press ▶ to continue.



#### 5 Start shooting.

Highlight **On** and press  (to return to the shooting menu without starting time-lapse photography, highlight **Off** and press .



Time-lapse photography starts after 3 s. The camera takes photographs at the interval selected in Step 3 for the time selected in Step 4. The memory card access lamp lights while each shot is recorded; note that because shutter speed and the time needed to record the image to the memory card may vary from shot to shot, the interval between a shot being recorded and the start of the next shot may vary. Shooting will not begin if a time-lapse movie can not be recorded at current settings (for example, if the memory card is full, the interval or shooting time is zero, the interval is longer than the shooting time, or remote () release mode is selected).

When complete, time-lapse movies are recorded to the memory card selected for **Movie settings > Destination** ( 65).



## ✓ Time-Lapse Photography

Time-lapse is not available in live view (☐ 49, 57), at a shutter speed of  $\frac{1}{250}$  (☐ 79), when bracketing (☐ 153), High Dynamic Range (HDR, ☐ 139), multiple exposure (☐ 160), or interval timer photography (☐ 164) is active.

## ✍ Release Mode

Regardless of the release mode selected, the camera will take one shot at each interval. The self-timer can not be used. Time-lapse photography is not available in remote (☐) release mode.

## ✍ Calculating the Length of the Final Movie

The total number of frames in the final movie can be approximated by dividing the shooting time by the interval and rounding up. The length of the final movie can then be calculated by dividing the number of shots by the frame rate selected for **Movie settings** > **Frame size/frame rate**. A 48 frame movie recorded at **1920 × 1080; 24p**, for example, will be about two seconds long. The maximum length for movies recorded using time-lapse photography is 20 minutes.

## ✍ Cover the Viewfinder

To prevent light entering via the viewfinder interfering with exposure, remove the rubber eyecup and cover the viewfinder with the supplied DK-5 eyepiece cap (☐ 86).

## ✍ During Shooting

During time-lapse photography, a **INTVL** icon will flash and the time-lapse recording indicator will be displayed in the control panel. The time remaining (in hours and minutes) appears in the shutter-speed display immediately before each frame is recorded. At other times, the time remaining can be viewed by pressing the shutter-release button halfway. Regardless of the option selected for Custom Setting c2 (**Standby timer**, ☐ 227), the standby timer will not expire during shooting.

To view current time-lapse photography settings, press the **MENU** button between shots. While time-lapse photography is in progress, the time-lapse photography menu will show the interval and the time remaining. These settings can not be changed while time-lapse photography is in progress, nor can pictures be played back or other menu settings adjusted.

*Length recorded/  
maximum length*



*Memory card  
indicator*

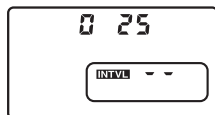

*Frame size/  
frame rate*





## ■ Interrupting Time-Lapse Photography

Time-lapse photography will end automatically if the battery is exhausted. The following will also end time-lapse photography:



- Selecting **Start > Off** in the **Time-lapse photography** menu
- Pressing the  button between frames or immediately after a frame is recorded
- Turning the camera off
- Removing the lens
- Connecting a USB or HDMI cable
- Inserting a memory card into an empty slot
- Pressing the shutter-release button all the way down to take a photograph
- Selecting remote () release mode
- Selecting mode **U1** or **U2**, or selecting another mode after starting time-lapse photography in mode **U1** or **U2**

A movie will be created from the frames shot to the point where time-lapse photography ended. Note that time-lapse photography will end and no movie will be recorded if the power source is removed or disconnected or the destination memory card is ejected.

## ■ No Photograph

The camera will skip the current frame if it is unable to focus using single-servo autofocus (**AF-S** or single-servo autofocus selected for **AF-A**; note that the camera focuses again before each shot). Shooting will resume with the next frame.

### **Image Review**

The  button can not be used to view pictures while time-lapse photography is in progress, but the current frame will be displayed for a few seconds after each shot if **On** is selected for **Image review** in the playback menu ( 212). Other playback operations can not be performed while the frame is displayed.

### **See Also**

For information on setting a beep to sound when time-lapse photography is complete, see Custom Setting d1 (**Beep**,  228).



# Non-CPU Lenses

By specifying lens data (lens focal length and maximum aperture), the user can gain access to a variety of CPU lens functions when using a non-CPU lens.

*If the focal length of the lens is known:*

- Power zoom can be used with optional flash units (☐ 294)
- Lens focal length is listed (with an asterisk) in the playback photo info display

*If the maximum aperture of the lens is known:*

- The aperture value is displayed in the control panel and viewfinder
- Flash level is adjusted for changes in aperture if the flash unit supports AA (auto aperture) mode
- Aperture is listed (with an asterisk) in the playback photo info display

*Specifying both the focal length and maximum aperture of the lens:*

- Enables color matrix metering (note that it may be necessary to use center-weighted or spot metering to achieve accurate results with some lenses, including Reflex-NIKKOR lenses)
- Improves the precision of center-weighted and spot metering and i-TTL balanced fill-flash for digital SLR



The camera can store data for up to nine non-CPU lenses. To enter or edit data for a non-CPU lens:

### 1 Select Non-CPU lens data.

Press the **MENU** button to display the menus. Highlight **Non-CPU lens data** in the setup menu and press **▶**.

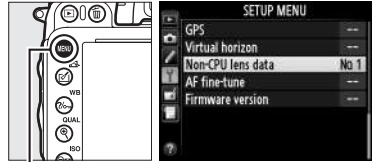

MENU button

### 2 Choose a lens number.

Highlight **Lens number** and press **◀** or **▶** to choose a lens number between 1 and 9.

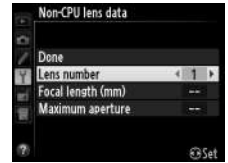

### 3 Enter the focal length and aperture.

Highlight **Focal length (mm)** or **Maximum aperture** and press **◀** or **▶** to edit the highlighted item. Focal length can be selected from values between 6 and 4,000 mm, maximum aperture from values between f/1.2 and f/22.

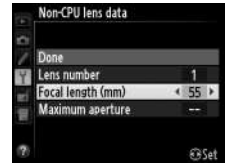

#### **Focal Length Not Listed**

If the correct focal length is not listed, choose the closest value greater than the actual focal length of the lens.

#### **Teleconverters and Zoom Lenses**

The maximum aperture for teleconverters is the combined maximum aperture of the teleconverter and the lens. Note that lens data are not adjusted when non-CPU lenses are zoomed in or out. The data for different focal lengths can be entered as separate lens numbers, or the data for the lens can be edited to reflect the new values for lens focal length and maximum aperture each time zoom is adjusted.

### 4 Select Done.

Highlight **Done** and press **OK**. The specified focal length and aperture will be stored under the chosen lens number.

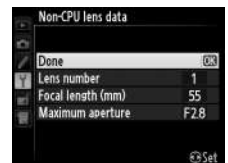

To recall lens data when using a non-CPU lens:

## 1 Assign non-CPU lens number selection to a camera control.

Select **Choose non-CPU lens number** for Custom Setting f2 (**Assign Fn button**, □ 242) or Custom Setting f3 (**Assign preview button**, □ 244).

## 2 Use the selected control to choose the lens number.

Press the selected button and rotate the main command dial until the desired lens number is displayed in the control panel.

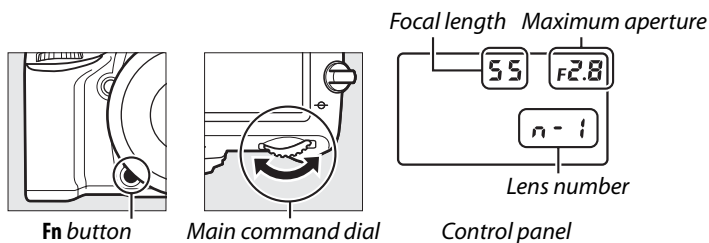

# The GP-1/GP-1A GPS Unit

The GP-1/GP-1A GPS unit (available separately) can be connected to the camera's accessory terminal (☐ 298) using the cable supplied with the GP-1/GP-1A, allowing information on the camera's current position to be recorded when photographs are taken. Turn the camera off before connecting the GP-1/GP-1A; for more information, see the GP-1/GP-1A manual.

## ■ Setup Menu Options

The **GPS** item in the setup menu contains the options listed below.

- **Standby timer:** Choose whether the exposure meters turn off automatically when the GP-1/GP-1A is attached.

Option	Description
<b>Enable</b>	Exposure meters turn off automatically if no operations are performed for the time selected for Custom Setting c2 ( <b>Standby timer</b> , ☐ 227; to allow the camera time to acquire GPS data, the delay is extended by up to one minute after the exposure meters are activated or the camera is turned on). This reduces the drain on the battery.
<b>Disable</b>	Exposure meters do not turn off while the GP-1/GP-1A is connected.

- **Position:** This item is only available if the GP-1/GP-1A is connected, when it displays the current latitude, longitude, altitude, and Coordinated Universal Time (UTC) as reported by the GP-1/GP-1A.
- **Use GPS to set camera clock:** Select **Yes** to synchronize the camera clock with the time reported by the GPS device.

### 📌 Coordinated Universal Time (UTC)

UTC data is provided by the GPS device and is independent of the camera clock.

### 📌 The GPS Icon

Connection status is shown by the  icon:

- **GPS (static):** Camera has established communication with GP-1/GP-1A. Photo information for pictures taken while this icon is displayed include an additional page of GPS data (☐ 183).
- **GPS (flashing):** The GP-1/GP-1A is searching for a signal. Pictures taken while the icon is flashing do not include GPS data.
- **No icon:** No new GPS data have been received from the GP-1/GP-1A for at least two seconds. Pictures taken when the  icon is not displayed do not include GPS data.







# More on Playback

## Full-Frame Playback

To play photographs back, press the  button. The most recent photograph will be displayed in the monitor.



 button

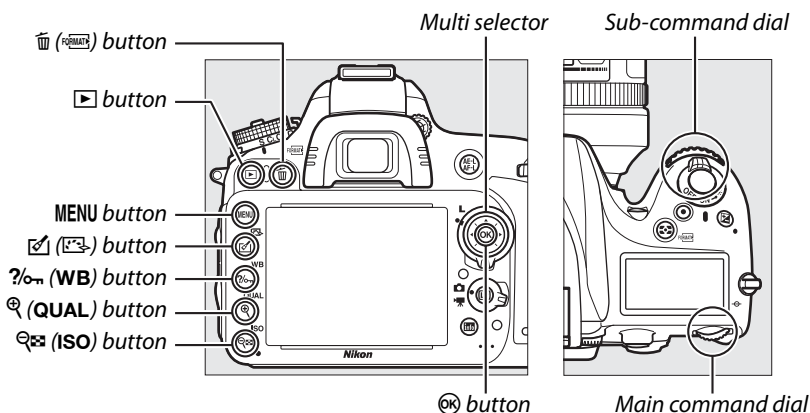











### Rotate Tall

To display “tall” (portrait-orientation) photographs in tall orientation, select **On** for the **Rotate tall** option in the playback menu ( 212).

### Image Review

When **On** is selected for **Image review** in the playback menu ( 212), photographs are automatically displayed in the monitor for about 4 s after shooting (because the camera is already in the correct orientation, images are not rotated automatically during image review). In continuous release mode, display begins when shooting ends, with the first photograph in the current series displayed.

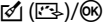

To	Use	Description
View additional photographs		Press ► to view photographs in order recorded, ◀ to view photographs in reverse order.
View photo information		Press ▲ or ▼ to view information about current photograph (□ 179).
View thumbnails		See page 185 for more information.
Zoom in on photograph		See page 187 for more information.
Delete images		Confirmation dialog will be displayed. Press  again to delete photo.
Change protect status		To protect image, or to remove protection from protected image, press  (□ 188).
Return to shooting mode		Monitor will turn off. Photographs can be taken immediately.
Retouch photo or play movie		Create retouched copy of current photograph (□ 261). If current picture is marked with  icon to show that it is a movie, pressing  starts movie playback (□ 67).

### Choosing a Memory Card Slot

If two memory cards are inserted, you can select a card for playback by holding the **BKT** button and pressing ▲ during full-frame or thumbnail playback. The dialog shown at right will be displayed; highlight the desired slot and press ► to list the folders on the selected card, then highlight a folder and press  to view the pictures in the highlighted folder. The same procedure can be used when selecting pictures for operations in the playback (□ 207) and retouch (□ 261) menus or when copying white balance from an existing photograph (□ 125).

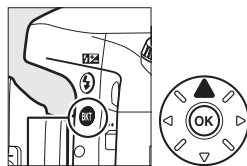

**BKT button**

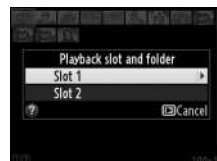

### See Also

For information on choosing how long the monitor will remain on when no operations are performed, see Custom Setting c4 (**Monitor off delay**, □ 228).



# Photo Information

Photo information is superimposed on images displayed in full-frame playback. Press ▲ or ▼ to cycle through photo information as shown below. Note that “image only”, shooting data, RGB histograms, highlights, and overview data are only displayed if corresponding option is selected for **Playback display options** (☐ 209). GPS data are only displayed if a GPS device was used when the photo was taken.

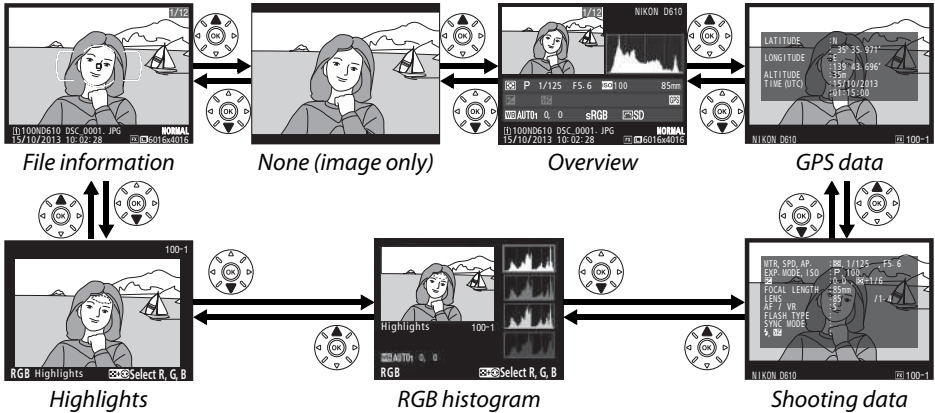

## File Information

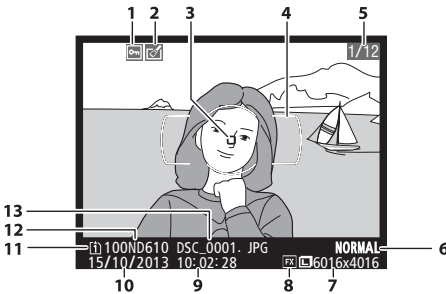

1	Protect status .....	188
2	Retouch indicator .....	261
3	Focus point <sup>1, 2</sup> .....	101
4	AF area brackets <sup>1</sup> .....	33
5	Frame number/total number of frames	
6	Image quality .....	93
7	Image size .....	95
8	Image area <sup>3</sup> .....	89
9	Time of recording .....	27, 253
10	Date of recording .....	27, 253
11	Current card slot .....	46, 178
12	Folder name .....	215
13	File name .....	216

- 1 Displayed only if **Focus point** is selected for **Playback display options** (☐ 209).
- 2 If photograph was taken using **AF-S** or with single-servo autofocus selected during **AF-A**, display shows point where focus first locked. If photograph was taken using **AF-C** or with continuous-servo autofocus selected during **AF-A**, focus point is only displayed if option other than auto-area AF was selected for AF-area mode and camera was able to focus.
- 3 Displayed in yellow if picture is in non-FX format (including DX-based movie format; ☐ 63, 89).



## Highlights

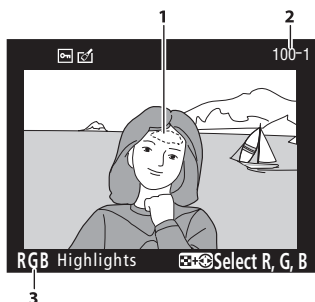

- 1 Image highlights <sup>1</sup>
- 2 Folder number—frame number <sup>2</sup> ..... 215
- 3 Current channel <sup>1</sup>

1 Flashing areas indicate highlights (areas that may be overexposed) for the current channel. Hold **Q** (ISO) button and press **◀** or **▶** to cycle through channels as follows:

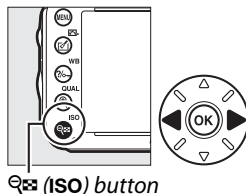
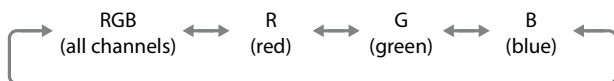

2 Displayed in yellow if picture is in non-FX format (including DX-based movie format; 63, 89).

## RGB Histogram

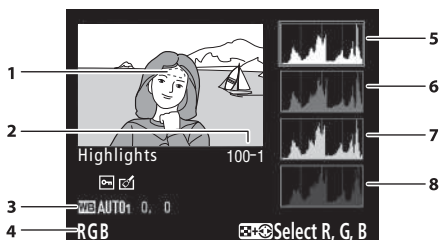

- 3 White balance ..... 115
- Color temperature ..... 120
- White balance fine-tuning ..... 117
- Preset manual ..... 121
- 4 Current channel <sup>1</sup>
- 5 Histogram (RGB channel). In all histograms, horizontal axis gives pixel brightness, vertical axis number of pixels.
- 6 Histogram (red channel)
- 7 Histogram (green channel)
- 8 Histogram (blue channel)

- 1 Image highlights <sup>1</sup>
- 2 Folder number—frame number <sup>2</sup> .....215

1 Flashing areas indicate highlights (areas that may be overexposed) for the current channel. Hold **Q** (ISO) button and press **◀** or **▶** to cycle through channels as follows:

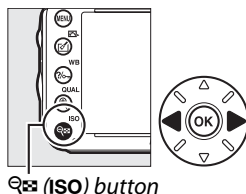
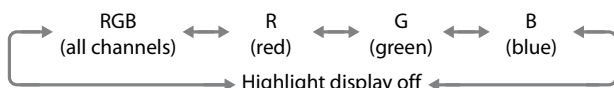

2 Displayed in yellow if picture is in non-FX format (including DX-based movie format; 63, 89).

## Playback Zoom

To zoom in on the photograph when the histogram is displayed, press **Q (QUAL)**. Use the **Q (QUAL)** and **ISO** buttons to zoom in and out and scroll the image with the multi selector. The histogram will be updated to show only the data for the portion of the image visible in the monitor.



## Histograms

Camera histograms are intended as a guide only and may differ from those displayed in imaging applications. Some sample histograms are shown below:

If the image contains objects with a wide range of brightnesses, the distribution of tones will be relatively even.



If the image is dark, tone distribution will be shifted to the left.

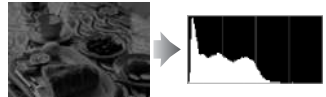

If the image is bright, tone distribution will be shifted to the right.



Increasing exposure compensation shifts the distribution of tones to the right, while decreasing exposure compensation shifts the distribution to the left. Histograms can provide a rough idea of overall exposure when bright ambient lighting makes it difficult to see photographs in the monitor.



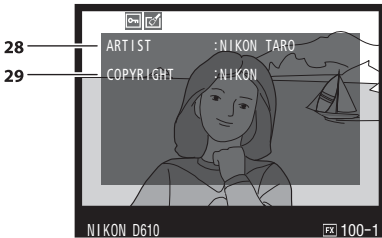
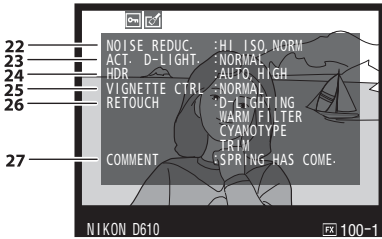
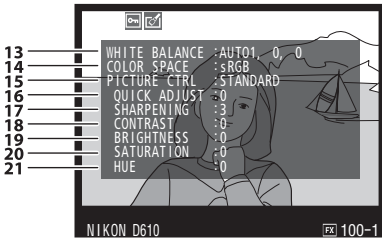
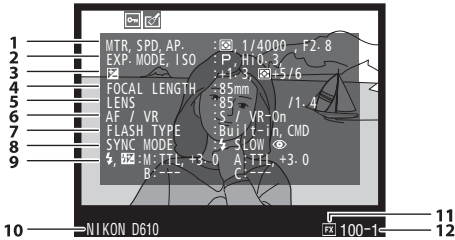

## ■ Shooting Data



1	Metering .....	109
	Shutter speed .....	74
	Aperture .....	74
2	Shooting mode .....	35, 40, 73
	ISO sensitivity <sup>1</sup> .....	105

3	Exposure compensation.....	112
	Optimal exposure tuning <sup>2</sup> .....	226
4	Focal length .....	172, 288, 291
5	Lens data.....	172
6	Focus mode.....	97, 103
	Lens VR (vibration reduction) <sup>3</sup>	
7	Flash type.....	143, 292
	Commander mode .....	237
8	Flash mode.....	144
9	Flash control .....	236, 294, 295
	Flash compensation .....	148
10	Camera name	
11	Image area <sup>4</sup> .....	89
12	Folder number—frame number <sup>4</sup> .....	215
13	White balance .....	115
	Color temperature.....	120
	White balance fine-tuning .....	117
	Preset manual .....	121
14	Color space.....	217
15	Picture Control .....	129
16	Quick adjust <sup>5</sup> .....	132
	Original Picture Control <sup>6</sup> .....	135
17	Sharpening.....	132
18	Contrast.....	132
19	Brightness.....	132
20	Saturation <sup>7</sup> .....	132
	Filter effects <sup>8</sup> .....	132
21	Hue <sup>7</sup> .....	132
	Toning <sup>8</sup> .....	132, 133
22	High ISO noise reduction .....	218
	Long exposure noise reduction.....	218
23	Active D-Lighting.....	137
24	HDR exposure differential.....	139
	HDR smoothing .....	139
25	Vignette control.....	218
26	Retouch history .....	261
27	Image comment .....	253
28	Name of photographer <sup>9</sup> .....	256
29	Copyright holder <sup>9</sup> .....	256

- 1 Displayed in red if photo was taken with auto ISO sensitivity control on.
- 2 Displayed if Custom Setting b5 (**Fine-tune optimal exposure**, ) has been set to a value other than zero for any metering method.
- 3 Displayed only if VR lens is attached.
- 4 Displayed in yellow if picture is in non-FX format (including DX-based movie format; ) 63, 89).
- 5 **Standard, Vivid, Portrait, and Landscape** Picture Controls only.
- 6 **Neutral, Monochrome**, and custom Picture Controls.
- 7 Not displayed with monochrome Picture Controls.
- 8 Monochrome Picture Controls only.
- 9 The fourth page of the shooting data is only displayed if copyright information was recorded with the photograph as described on page 256.

## **GPS Data** \*

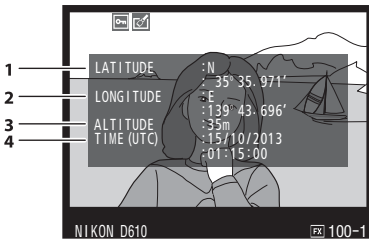

- |   |                                  |
|---|----------------------------------|
| 1 | Latitude                         |
| 2 | Longitude                        |
| 3 | Altitude                         |
| 4 | Coordinated Universal Time (UTC) |

\* Data for movies are for start of recording.



## Overview Data

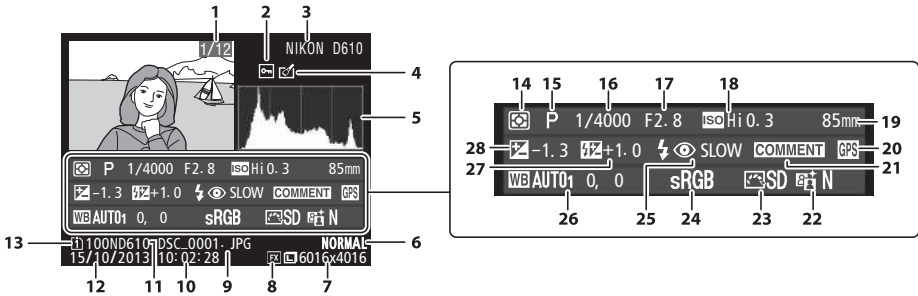

<b>1</b>	Frame number/total number of images	
<b>2</b>	Protect status	188
<b>3</b>	Camera name	
<b>4</b>	Retouch indicator	261
<b>5</b>	Histogram showing the distribution of tones in the image (☐ 181).	
<b>6</b>	Image quality	93
<b>7</b>	Image size	95
<b>8</b>	Image area <sup>1</sup>	89
<b>9</b>	File name	216
<b>10</b>	Time of recording	27, 253
<b>11</b>	Folder name	215
<b>12</b>	Date of recording	27, 253
<b>13</b>	Current card slot	46, 178
<b>14</b>	Metering	109
<b>15</b>	Shooting mode	35, 40, 73
<b>16</b>	Shutter speed	74

<b>17</b>	Aperture	74
<b>18</b>	ISO sensitivity <sup>2</sup>	105
<b>19</b>	Focal length	172, 288, 291
<b>20</b>	GPS data indicator	175
<b>21</b>	Image comment indicator	253
<b>22</b>	Active D-Lighting	137
<b>23</b>	Picture Control	129
<b>24</b>	Color space	217
<b>25</b>	Flash mode	144
<b>26</b>	White balance	115
	Color temperature	120
	White balance fine-tuning	117
	Preset manual	121
<b>27</b>	Flash compensation	148
	Commander mode	237
<b>28</b>	Exposure compensation	112

1 Non-FX formats (including DX-based movie format) displayed in yellow (☐ 63, 89).

2 Displayed in red if photo was taken with auto ISO sensitivity control on.



# Thumbnail Playback

To display images in “contact sheets” of four, nine, or 72 images, press the **ISO** button.

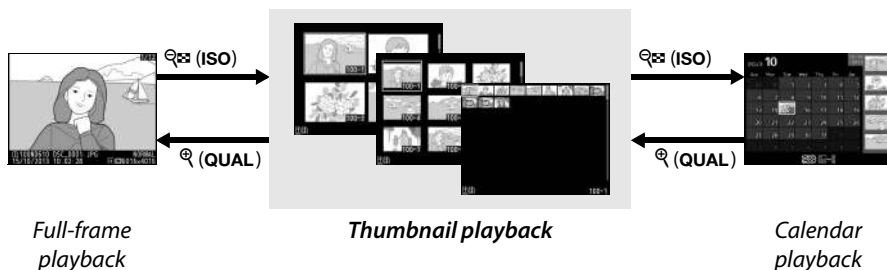

To	Use	Description
Display more images	<b>ISO</b>	Press <b>ISO</b> to increase the number of images displayed.
Display fewer images	<b>QUAL</b>	Press <b>QUAL</b> to reduce the number of images displayed. When four images are displayed, press to view highlighted image full frame.
Highlight images		Use multi selector to highlight images for full-frame playback, playback zoom (187), deletion (189), or protection (188).
View highlighted image	<b>OK</b>	Press <b>OK</b> to display the highlighted image full frame.
Delete highlighted image		See page 189 for more information.
Change protect status of highlighted image	<b>WB</b>	See page 188 for more information.
Return to shooting mode		Monitor will turn off. Photographs can be taken immediately.
Retouch photo		Create retouched copy of current photograph (69, 261).







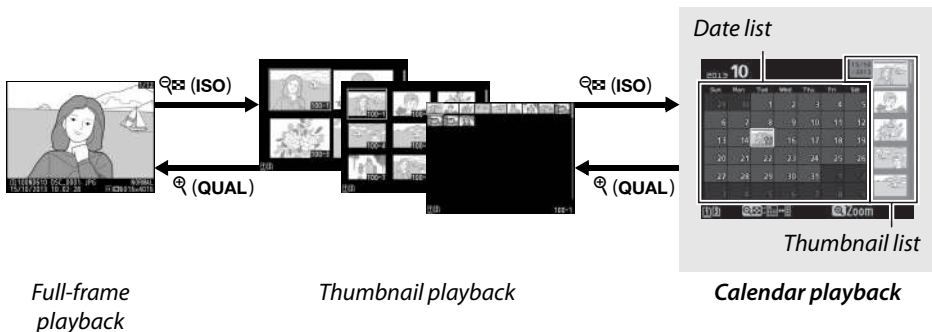







# Calendar Playback

To view images taken on a selected date, press the  (ISO) button when 72 images are displayed.









The operations can be performed depend on whether the cursor is in the date list or the thumbnail list:

To	Use	Description
Toggle between date list and thumbnail list	 (ISO)	Press  (ISO) button in date list to place cursor in thumbnail list. Press again to return to date list.
Exit to thumbnail playback/Zoom in on highlighted photo	 (QUAL)	<ul style="list-style-type: none"> <li><b>Date list:</b> Exit to 72-frame playback.</li> <li><b>Thumbnail list:</b> Press and hold  (QUAL) button to zoom in on highlighted picture.</li> </ul>
Highlight dates/Highlight images		<ul style="list-style-type: none"> <li><b>Date list:</b> Highlight date.</li> <li><b>Thumbnail list:</b> Highlight picture.</li> </ul>
Toggle full frame playback		<ul style="list-style-type: none"> <li><b>Date list:</b> View pictures taken on selected date.</li> <li><b>Thumbnail list:</b> View highlighted picture.</li> </ul>
Delete highlighted photo(s)	 (FORMAT)	<ul style="list-style-type: none"> <li><b>Date list:</b> Delete all pictures taken on selected date.</li> <li><b>Thumbnail list:</b> Delete highlighted picture ( 189).</li> </ul>
Change protect status of highlighted photo	 (WB)	See page 188 for more information.
Return to shooting mode		Monitor will turn off. Photographs can be taken immediately.
Retouch photo	 (RET)	Create retouched copy of photo highlighted in thumbnail list (  69, 261).



# Taking a Closer Look: Playback Zoom

Press the **Q (QUAL)** button to zoom in on the image displayed in full-frame playback or on the image currently highlighted in thumbnail playback. The following operations can be performed while zoom is in effect:

To	Use	Description
Zoom in or out	<b>Q (QUAL)</b> / <b>ISO</b>	Press <b>Q (QUAL)</b> to zoom in to maximum of approximately 38 × (large images in 36 × 24/3 : 2 format), 28 × (medium images) or 19 × (small images). Press <b>ISO</b> to zoom out. While photo is zoomed in, use multi selector to view areas of image not visible in monitor. 
View other areas of image		Keep multi selector pressed to scroll rapidly to other areas of frame. Navigation window is displayed when zoom ratio is altered; area currently visible in monitor is indicated by yellow border.
Select faces		Faces (up to 35) detected during zoom are indicated by white borders in navigation window. Rotate sub-command dial to view other faces. 
View other images		Rotate main command dial to view same location in other photos at current zoom ratio. Playback zoom is cancelled when a movie is displayed.
Change protect status	<b>WB</b>	See page 188 for more information.
Return to shooting mode		Monitor will turn off. Photographs can be taken immediately.
Retouch photo		Create retouched copy of current photograph (69, 261).



# Protecting Photographs from Deletion

In full-frame, zoom, thumbnail, and calendar playback, the **WB** button can be used to protect photographs from accidental deletion. Protected files can not be deleted using the **FORMAT** button or the **Delete** option in the playback menu. Note that protected images *will* be deleted when the memory card is formatted (31, 250).

To protect a photograph:

## 1 Select an image.

Display the image in full-frame playback or playback zoom or highlight it in the thumbnail list in thumbnail or calendar playback.



Full-frame playback



Thumbnail playback



Calendar playback

## 2 Press the **WB** button.

The photograph will be marked with a **WB** icon. To remove protection from the photograph so that it can be deleted, display the photograph or highlight it in the thumbnail list and then press the **WB** button.



**WB** button

### Removing Protection from All Images

To remove protection from all images in the folder or folders currently selected in the **Playback folder** menu, press the **WB** and **FORMAT** buttons together for about two seconds during playback.

# Deleting Photographs

To delete the photograph displayed in full-frame playback or highlighted in the thumbnail list, press the  (FORMAT) button. To delete multiple selected photographs, all photographs taken on a selected date, or all photographs in the current playback folder, use the **Delete** option in the playback menu. Once deleted, photographs can not be recovered. Note that pictures that are protected or hidden can not be deleted.

## Full-Frame, Thumbnail, and Calendar Playback

Press the  (FORMAT) button to delete the current photograph.

### 1 Select an image.

Display the image or highlight it in the thumbnail list in thumbnail or calendar playback.

### 2 Press the (FORMAT) button.

A confirmation dialog will be displayed.

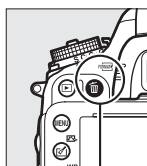

 (FORMAT) button



Full-frame playback

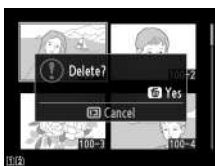



Thumbnail playback



Calendar playback  
(thumbnail list)

### 3 Press the (FORMAT) button again.

To delete the photograph, press the  (FORMAT) button. To exit without deleting the photograph, press the  button.

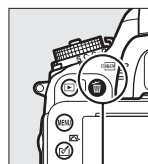

 (FORMAT) button

#### Calendar Playback

During calendar playback, you can delete all photographs taken on a selected date by highlighting the date in the date list and pressing the  (FORMAT) button ([□ 186](#)).



#### See Also

The **After delete** option in the playback menu determines whether the next image or the previous image is displayed after an image is deleted ([□ 212](#)).



# The Playback Menu

The **Delete** option in the playback menu contains the following options. Note that depending on the number of images, some time may be required for deletion.

Option	Description
 <b>Selected</b>	Delete selected pictures.
 <b>Select date</b>	Delete all pictures taken on a selected date (📅 191).
<b>ALL All</b>	Delete all pictures in the folder currently selected for playback (📅 207). If two cards are inserted, you can select the card from which pictures will be deleted.

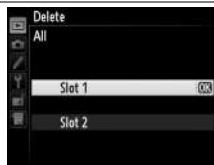

## ■ Selected: Deleting Selected Photographs

### 1 Choose Selected for the Delete option in the playback menu.

Press the **MENU** button and select **Delete** in the playback menu. Highlight **Selected** and press **▶**.

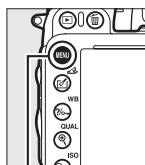

MENU button

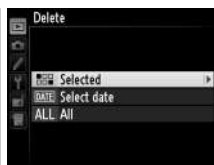

### 2 Highlight a picture.

Use the multi selector to highlight a picture (to view the highlighted picture full screen, press and hold the **QUAL** button; to view images in other locations, hold the **BKT** button, press **▲**, and select the desired card and folder as described on page 178).



### 3 Select the highlighted picture.

Press the **ISO** button to select the highlighted picture. Selected pictures are marked by a  icon. Repeat steps 2 and 3 to select additional pictures; to deselect a picture, highlight it and press **ISO**.

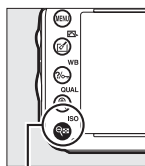

ISO (ISO) button



#### 4 Press **OK** to complete the operation.

A confirmation dialog will be displayed; highlight **Yes** and press **OK**.



### ■ Select Date: Deleting Photographs Taken on a Selected Date

#### 1 Choose **Select date**.

In the delete menu, highlight **Select date** and press **▶**.

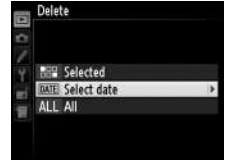

#### 2 Highlight a date.

Press **▲** or **▼** to highlight a date.

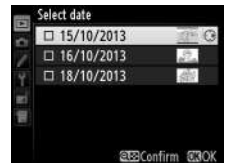

To view the pictures taken on the highlighted date, press **ISO**. Use the multi selector to scroll through the pictures, or press and hold **QUAL** to view the current picture full screen. Press **ISO** to return to the date list.

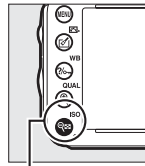

**ISO** button



#### 3 Select the highlighted date.

Press **▶** to select all pictures taken on the highlighted date. Selected dates are marked with a **☑** icon. Repeat steps 2 and 3 to select additional dates; to deselect a date, highlight it and press **▶**.

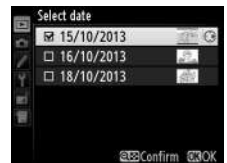

#### 4 Press **OK** to complete the operation.

A confirmation dialog will be displayed; highlight **Yes** and press **OK**.

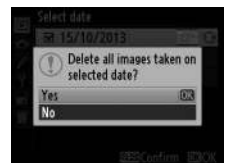



# Connections

## Connecting to a Computer

This section describes how to use the supplied USB cable to connect the camera to a computer.

### Before Connecting the Camera

Before connecting the camera, install the software on the supplied ViewNX 2 CD. To ensure that data transfer is not interrupted, be sure the camera EN-EL15 battery is fully charged. If in doubt, charge the battery before use or use an EH-5b AC adapter and EP-5B power connector (available separately).

#### ■ ■ *Supplied Software*

ViewNX 2 includes a “Nikon Transfer 2” function for copying pictures from the camera to the computer, where ViewNX 2 can be used to view and print selected images or to edit photographs and movies. For more information, see ViewNX 2 online help.

#### ■ ■ *Supported Operating Systems*

The supplied software can be used with computers running the following operating systems:

- **Windows:** Pre-installed versions of Windows 8, Windows 7, Windows Vista, and Windows XP; not compatible with 64-bit editions of Windows XP.
- **Macintosh:** OS X 10.8 or 10.7, Mac OS X 10.6

See the websites listed on page xxiii for the latest information on supported operating systems.

#### **Connecting Cables**

Be sure the camera is off when connecting or disconnecting interface cables. Do not use force or attempt to insert the connectors at an angle. Close the camera connector cover when the connector is not in use.

#### **During Transfer**

Do not turn the camera off or disconnect the USB cable while transfer is in progress.

#### **Windows**

To visit the Nikon website after installing ViewNX 2, select **All Programs > Link to Nikon** from the Windows start menu (Internet connection required).

# Connecting the Camera

Connect the camera using the supplied USB cable.

**1 Turn the camera off.**

**2 Turn the computer on.**

Turn the computer on and wait for it to start up.

**3 Connect the USB cable.**

Connect the USB cable as shown.

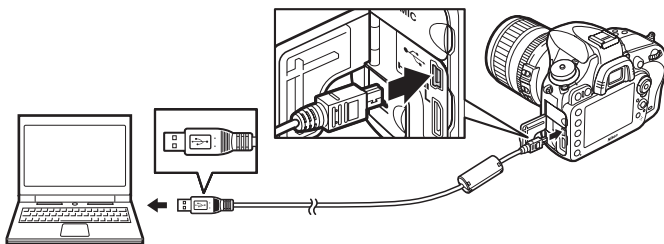

**✔ USB Hubs**

Connect the camera directly to the computer; do not connect the cable via a USB hub or keyboard.

**4 Turn the camera on.**

**5 Start Nikon Transfer 2.**

If a message is displayed prompting you to choose a program, select Nikon Transfer 2.

**✔ Windows 7**

If the following dialog is displayed, select Nikon Transfer 2 as described below.

- 1 Under **Import pictures and videos**, click **Change program**. A program selection dialog will be displayed; select **Import file using Nikon Transfer 2** and click **OK**.
- 2 Double-click **Import file**.





---

## 6 Click Start Transfer.

At default settings, all the pictures on the memory card will be copied to the computer (for more information on using Nikon Transfer 2, start ViewNX 2 or Nikon Transfer 2 and select **ViewNX 2 Help** from the **Help** menu).



*Start Transfer*

---

## 7 Turn the camera off and disconnect the USB cable when transfer ends.

Nikon Transfer 2 will close automatically when transfer is complete.

### **Camera Control Pro 2**

Camera Control Pro 2 software (available separately; □ 298) can be used to control the camera from a computer. When Camera Control Pro 2 is used to capture photographs and movies directly to the computer, the PC connection indicator (P C) will appear in the control panel.



# Printing Photographs

Selected JPEG images can be printed on a PictBridge printer (☎ 333) connected directly to the camera.

## Connecting the Printer

Connect the camera using the supplied USB cable.

**1** Turn the camera off.

**2** Connect the USB cable.

Turn the printer on and connect the USB cable as shown. Do not use force or attempt to insert the connectors at an angle.

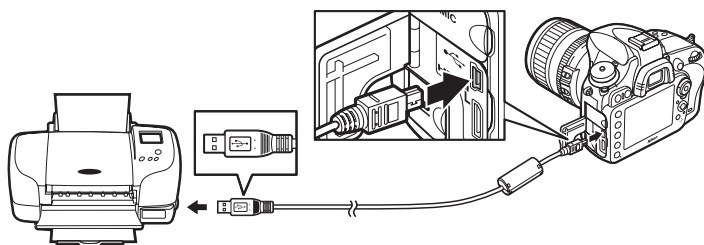

**USB Hubs**

Connect the camera directly to the printer; do not connect the cable via a USB hub.

**3** Turn the camera on.

A welcome screen will be displayed in the monitor, followed by a PictBridge playback display.

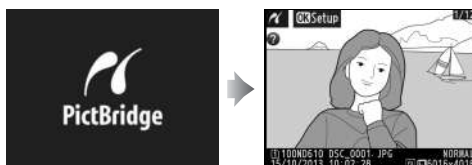

### **Printing Via Direct USB Connection**

Be sure the EN-EL15 battery is fully charged or use an optional EH-5b AC adapter and EP-5B power connector. When taking photographs to be printed via direct USB connection, set **Color space to sRGB** (□ 217).

### **Selecting Photographs for Printing**

NEF (RAW) photographs (□ 93) can not be selected for printing. JPEG copies of NEF (RAW) images can be created using the **NEF (RAW) processing** option in the retouch menu (□ 271).

### **See Also**

See page 325 for information on what to do if an error occurs during printing.

## Printing Pictures One at a Time

### **1** Select a picture.

Press ◀ or ▶ to view additional pictures. Press the **Q (QUAL)** button to zoom in on the current frame (□ 187; press ▶ to exit zoom). To view six pictures at a time, press the **ISO** button. Use the multi selector to highlight pictures, or press **Q (QUAL)** to display the highlighted picture full frame; to view images in other locations when thumbnails are displayed, hold the **BKT** button, press ▲, and select the desired card and folder as described on page 178.



### **2** Display printing options.

Press **OK** to display PictBridge printing options.

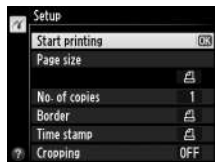

### 3 Adjust printing options.

Press ▲ or ▼ to highlight an option and press ► to select.

Option	Description
Page size	Highlight a page size (only sizes supported by the current printer are listed) and press <b>OK</b> to select and exit to the previous menu (to print at the default page size for the current printer, select <b>Printer default</b> ).
No. of copies	Press ▲ or ▼ to choose number of copies (maximum 99), then press <b>OK</b> to select and return to the previous menu.
Border	This option is available only if supported by the printer. Highlight <b>Printer default</b> (use current printer settings), <b>Print with border</b> (print photo with white border), or <b>No border</b> and press <b>OK</b> to select and exit to the previous menu.
Time stamp	Highlight <b>Printer default</b> (use current printer settings), <b>Print time stamp</b> (print times and dates of recording on photos), or <b>No time stamp</b> and press <b>OK</b> to select and exit to the previous menu.
Cropping	This option is available only if supported by the printer. To exit without cropping, highlight <b>No cropping</b> and press <b>OK</b> . To crop the current picture, highlight <b>Crop</b> and press ►. Selecting <b>Crop</b> displays the dialog shown at right. Press <b>QUAL</b> to increase the size of the crop, <b>ISO</b> to decrease. Position the crop using the multi selector and press <b>OK</b> . Note that print quality may drop if small crops are printed at large sizes.



### 4 Start printing.

Select **Start printing** and press **OK** to start printing. To cancel before all copies have been printed, press **OK**.



# Printing Multiple Pictures

## 1 Display the PictBridge menu.

Press the **MENU** button in the PictBridge playback display (see Step 3 on page 196).

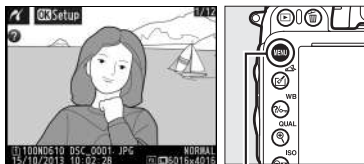

MENU button

## 2 Choose an option.

Highlight one of the following options and press ►.

- **Print select:** Select pictures for printing.
- **Select date:** Print one copy of all the pictures taken on a selected date.
- **Print (DPOF):** Print an existing print order created with the **DPOF print order** option in the playback menu (☞ 202). The current print order will be displayed in Step 3.
- **Index print:** To create an index print of all JPEG pictures (☞ 93) on the memory card, proceed to Step 4. Note that if the memory card contains more than 256 pictures, only the first 256 images will be printed.

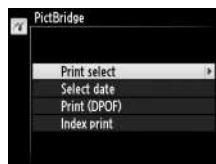

### 3 Select pictures or choose a date.

If you chose **Print select** or **Print (DPOF)** in **Step 2**, use the multi selector to scroll through the pictures on the memory card; to view images in other locations, hold the **BKT** button, press **▲**, and select the desired card and folder as described on page 178. To display the current picture full screen, press and hold the **Q (QUAL)** button. To select the current picture for printing, hold the **Q (ISO)** button and press **▲**. The picture will be marked with a  icon and the number of prints will be set to 1. Keeping the **Q (ISO)** button pressed, press **▲** or **▼** to specify the number of prints (up to 99; to deselect the picture, press **▼** when the number of prints is 1). Continue until all the desired pictures have been selected.

If you chose **Select date** in **Step 2**, press **▲** or **▼** to highlight a date and press **▶** to toggle the highlighted date on or off. To view the pictures taken on the selected date, press **Q (ISO)**. Use the multi selector to scroll through the pictures, or press and hold **Q (QUAL)** to view the current picture full screen. Press **Q (ISO)** again to return to the date selection dialog.

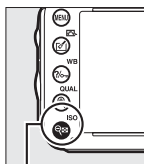
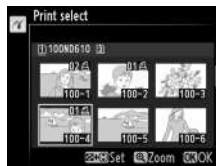

**Q (ISO) + ▲ ▼**: Choose number of copies

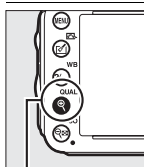

**Q (QUAL) button**: View photo full screen

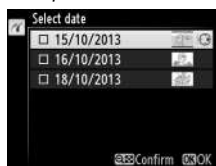

**Q (QUAL) button**: View highlighted photo full screen

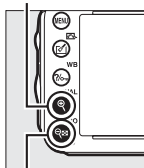

**Q (ISO) button**: View photos for selected date



---

## 4 Display printing options.

Press **OK** to display PictBridge printing options.

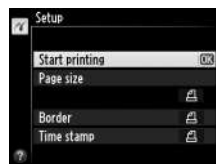

---

## 5 Adjust printing options.

Choose page size, border, and time stamp options as described on page 198 (a warning will be displayed if the selected page size is too small for an index print).

---

## 6 Start printing.

Select **Start printing** and press **OK** to start printing. To cancel before all copies have been printed, press **OK**.



# Creating a DPOF Print Order: Print Set

The **DPOF print order** option in the playback menu is used to create digital “print orders” for PictBridge-compatible printers and devices that support DPOF.

## 1 Choose **Select/set** for the **DPOF print order** item in the playback menu.

Press the **MENU** button and select **DPOF print order** in the playback menu. Highlight **Select/set** and press **▶** (to remove all photographs from the print order, select **Deselect all?**).

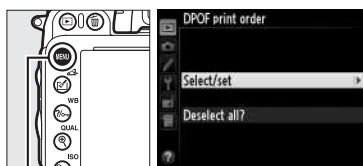

**MENU** button

## 2 Select pictures.

Use the multi selector to scroll through the pictures on the memory card (to view images in other locations, hold the **BKT** button and press **▲**). To display the current picture in full screen, press and hold the **Q (QUAL)** button. To select the current picture for printing, hold the **Q (ISO)** button and press **▲**. The picture will be marked with a  icon and the number of prints will be set to 1. Keeping the **Q (ISO)** button pressed, press **▲** or **▼** to specify the number of prints (up to 99; to deselect the picture, press **▼** when the number of prints is 1). Continue until all the desired pictures have been selected.

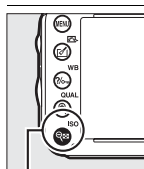

**Q (ISO) + ▲ ▼**: Choose number of copies

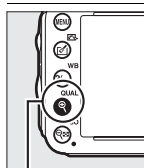

**Q (QUAL)** button: View photo full screen

## 3 Display imprint options.

Press **OK** to display data imprint options.

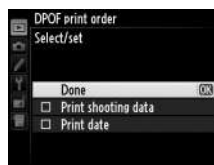



## 4 Select imprint options.

Highlight the following options and press ► to toggle the highlighted option on or off (to complete the print order without including this information, proceed to Step 5).

- **Print shooting data:** Print shutter speed and aperture on all pictures in print order.
- **Print date:** Print date of recording on all pictures in print order.

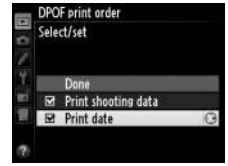

## 5 Complete the print order.

Highlight **Done** and press **OK** to complete the print order.

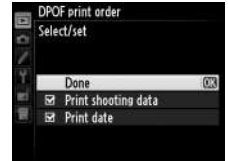

### ✓ DPOF Print Order

To print the current print order when the camera is connected to a PictBridge printer, select **Print (DPOF)** in the PictBridge menu and follow the steps in “Printing Multiple Pictures” to modify and print the current order (□ 199). DPOF print date and shooting data options are not supported when printing via direct USB connection; to print the date of recording on photographs in the current print order, use the PictBridge **Time stamp** option.

The **DPOF print order** option can not be used if there is not enough space on the memory card to store the print order.

NEF (RAW) photographs (□ 93) can not be selected using this option. JPEG copies of NEF (RAW) images can be created using the **NEF (RAW) processing** option in the retouch menu (□ 271).

Print orders may not print correctly if images are deleted using a computer or other device after the print order is created.



# Viewing Photographs on TV

A type C mini-pin High-Definition Multimedia Interface (HDMI) cable (available separately from commercial sources) can be used to connect the camera to high-definition video devices.

## 1 Turn the camera off.

Always turn the camera off before connecting or disconnecting an HDMI cable.

## 2 Connect the HDMI cable as shown.

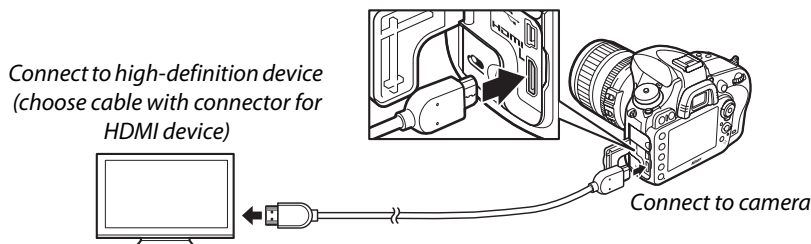

## 3 Tune the device to the HDMI channel.

## 4 Turn the camera on and press the button.

During playback, images will be displayed on the television screen.

### **Close the Connector Cover**

Close the camera connector cover when the connectors are not in use. Foreign matter in the connectors can interfere with data transfer.

### **Television Playback**

Use of an EH-5b AC adapter and EP-5B power connector (available separately) is recommended for extended playback. The TV will display images full screen if photo information is hidden during full-frame playback ( 179). Note that the edges may not be visible when photographs are viewed on a television screen.

### **Audio**

Stereo sound recorded with optional ME-1 ( 298) stereo microphones plays in stereo when movies are viewed on HDMI devices using a camera connected via an HDMI cable (note that audio will not be played back over headphones connected to the camera). Volume can be adjusted using television controls; the camera controls can not be used.

## ■ HDMI Options

The **HDMI** option in the setup menu (□ 249) controls output resolution and can be used to enable the camera for remote control from devices that support HDMI-CEC (High-Definition Multimedia Interface–Consumer Electronics Control, a standard that allows HDMI devices to be used to control peripherals to which they are connected).

### Output Resolution

Choose the format for images output to the HDMI device. If **Auto** is selected, the camera will automatically select the appropriate format. Regardless of the option selected, **Auto** will be used for movie live view, movie recording, and playback.

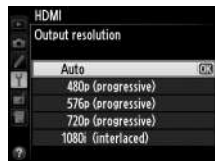

### Device Control

If **On** is selected for **HDMI > Device control** in the setup menu when the camera is connected to a television that supports HDMI-CEC and both the camera and television are on, the display shown at right will appear on the television and the television remote can be used in place of the camera multi selector and  button during full-frame playback and slide shows. If **Off** is selected, the television remote can not be used to control the camera.

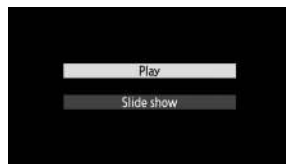

### HDMI and Live View

HDMI displays connected via an HDMI cable can be used for live view photography and movie live view (□ 49, 57). During movie live view and movie recording HDMI output is adjusted according to the option selected for **Movie settings > Frame size/frame rate** in the shooting menu (□ 65). Note that some HDMI devices may not support the selected setting; in this case, select **1080i (interlaced)** for **HDMI > Output resolution**. Movies may be output at a frame size smaller than that selected for **Frame size/frame rate** (□ 65).

### HDMI-CEC Devices

When the camera is connected to an HDMI-CEC device,  will appear in the control panel in place of the number of exposures remaining.

### Device Control

See the television manual for details.





# Menu Guide



## ▶ The Playback Menu: *Managing Images*

To display the playback menu, press **MENU** and select the  (playback menu) tab.



MENU button

The playback menu contains the following options:

Option		Option	
Delete	190	Image review	212
Playback folder	207	After delete	212
Hide image	208	Rotate tall	212
Playback display options	209	Slide show	213
Copy image(s)	209	DPOF print order	202

### See Also

Menu defaults are listed on page 312.

## Playback Folder

MENU button →  playback menu

Choose a folder for playback ( 177):

Option	Description
<b>ND610</b>	Pictures in all folders created with the D610 will be visible during playback.
<b>All</b>	Pictures in all folders will be visible during playback.
<b>Current</b>	Only pictures in the current folder will be visible during playback.

## Hide Image

MENU button →  playback menu

Hide or reveal pictures. Hidden pictures are visible only in the **Hide image** menu and can only be deleted by formatting the memory card.

Option	Description
<b>Select/set</b>	Hide or reveal selected pictures.
<b>Select date</b>	Selecting this option displays a list of dates. To hide all pictures taken on a date, highlight the date and press <b>▶</b> . Selected dates are marked by a <b>✓</b> ; to reveal all pictures taken on a selected date, highlight it and press <b>▶</b> . Press <b>OK</b> to complete the operation.
<b>Deselect all?</b>	Reveal all pictures.



### Protected and Hidden Images

Revealing a protected image will also remove protection from the image.

Follow the steps below to hide or reveal selected pictures.

## 1 Choose **Select/set**.

Highlight **Select/set** and press **▶**.



## 2 Select pictures.

Use the multi selector to scroll through the pictures on the memory card (to view the highlighted picture full screen, press and hold the **Q (QUAL)** button; to view images in other locations as described on page 178, hold **BKT** and press **▲**) and press **ISO** to select the current picture. Selected pictures are marked by a  icon; to deselect a picture, highlight it and press **ISO** again. Continue until all the desired pictures have been selected.

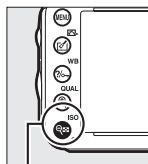

 (ISO) button



## 3 Press **OK**.

Press **OK** to complete the operation.

## Playback Display Options

MENU button →  playback menu

Choose the information available in the playback photo information display (📖 179). Press ▲ or ▼ to highlight an option, then press ► to select the option for the photo information display. A ✓ appears next to selected items; to deselect, highlight and press ►. To return to the playback menu, highlight **Done** and press .

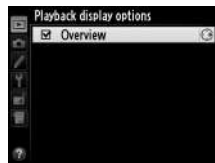

## Copy Image(s)

MENU button →  playback menu

Copy pictures from one memory card to another. This option is only available when two memory cards are inserted in the camera.

Option	Description
Select source	Choose card from which pictures will be copied.
Select image(s)	Select pictures to be copied.
Select destination folder	Select destination folder on remaining card.
Copy image(s)?	Copy selected pictures to specified destination.

### 1 Choose Select source.

Highlight **Select source** and press ►.

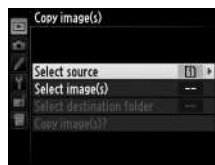

### 2 Select the source card.

Highlight the slot for the card containing the images to be copied and press .



- 3 Choose Select image(s).**  
Highlight **Select image(s)** and press ►.

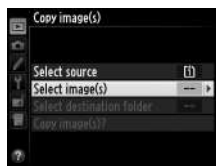

- 4 Select the source folder.**  
Highlight the folder containing the images to be copied and press ►.



- 5 Make the initial selection.**  
Before going on to select or deselect individual images, you can mark all or all protected images in the folder for copying by choosing **Select all images** or **Select protected images**. To mark only individually selected images for copying, choose **Deselect all** before proceeding.



- 6 Select additional images.**  
Highlight pictures and press **ISO** to select or deselect (to view the highlighted picture full screen, press and hold the **QUAL** button). Selected images are marked with a ✓. Press **OK** to proceed to Step 7 when your selection is complete.

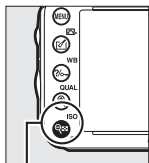

ISO button



- 7 Choose Select destination folder.**  
Highlight **Select destination folder** and press ►.

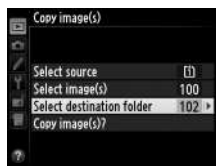



## 8 Select a destination folder.

To enter a folder number, choose **Select folder by number**, enter the number (□ 215), and press **OK**. If the folder with the selected number does not already exist, a new folder will be created.

To choose from a list of existing folders, choose **Select folder from list**, highlight a folder, and press **OK**.



## 9 Copy the images.

Highlight **Copy image(s)?** and press **OK**.

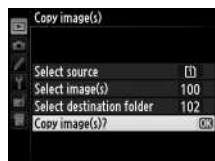

A confirmation dialog will be displayed; highlight **Yes** and press **OK**. Press **OK** again to exit when copying is complete.



### ✔ Copying Images

Images will not be copied if there is insufficient space on the destination card. Be sure the battery is fully charged before copying movies.

If the destination folder contains an image with the same name as one of the images to be copied, a confirmation dialog will be displayed. Select **Replace existing image** to replace the image with the image to be copied, or select **Replace all** to replace all existing images with the same names without further prompting. To continue without replacing the image, select **Skip**, or select **Cancel** to exit without copying any further images.



Protect status is copied with the images but print marking (□ 202) is not. Hidden images can not be copied.



## Image Review

MENU button →  playback menu

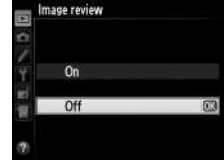

Choose whether pictures are automatically displayed in the monitor immediately after shooting. If **Off** is selected, pictures can only be displayed by pressing the  button.



## After Delete

MENU button →  playback menu

Choose the picture displayed after an image is deleted.

Option	Description
 <b>Show next</b>	Display following picture. If deleted picture was last frame, previous picture will be displayed.
 <b>Show previous</b>	Display previous picture. If deleted picture was first frame, following picture will be displayed.
 <b>Continue as before</b>	If user was scrolling through pictures in order recorded, following picture will be displayed as described for <b>Show next</b> . If user was scrolling through pictures in reverse order, previous picture will be displayed as described for <b>Show previous</b> .

## Rotate Tall

MENU button →  playback menu

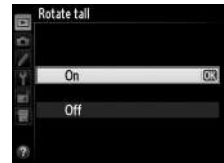

Choose whether to rotate “tall” (portrait-orientation) pictures for display during playback. Note that because the camera itself is already in the appropriate orientation during shooting, images are not rotated automatically during image review.



Option	Description
<b>On</b>	“Tall” (portrait-orientation) pictures are automatically rotated for display in the camera monitor. Pictures taken with <b>Off</b> selected for <b>Auto image rotation</b> (  254) will be displayed in “wide” (landscape) orientation.
<b>Off</b>	“Tall” (portrait-orientation) pictures are displayed in “wide” (landscape) orientation.













## Slide Show

MENU button →  playback menu

Create a slide show of the pictures in the current playback folder ( 207). Hidden images ( 208) are not displayed.

Option	Description
<b>Start</b>	Start slide show.
<b>Image type</b>	Choose type of image displayed from <b>Still images and movies</b> , <b>Still images only</b> , and <b>Movies only</b> .
<b>Frame interval</b>	Choose how long each picture will be displayed.

To start the slide show, highlight **Start** and press . The following operations can be performed while the slide show is in progress:

To	Press	Description
Skip back/skip ahead		Press  to return to previous frame,  to skip to next frame.
View additional photo info		Change or hide photo info displayed (still images only;  179).
Pause/resume		Pause or resume slide show.
Raise/lower volume	 (QUAL) /  (ISO)	Press  (QUAL) during movie playback to increase volume,  (ISO) to decrease.
Exit to playback menu	MENU	End slide show and return to playback menu.
Exit to playback mode		End show and return to playback mode.
Exit to shooting mode		Press shutter-release button halfway to return to shooting mode.

The dialog shown at right is displayed when the show ends. Select **Restart** to restart or **Exit** to return to the playback menu.





# The Shooting Menu: *Shooting Options*

To display the shooting menu, press **MENU** and select the  (shooting menu) tab.



MENU button

The shooting menu contains the following options:

Option		Option	
Reset shooting menu	214	Color space	217
Storage folder	215	Active D-Lighting	137
File naming	216	HDR (high dynamic range)	139
Role played by card in Slot 2	96	Vignette control	218
Image quality	93	Long exposure NR	218
Image size	95	High ISO NR	218
Image area	89	ISO sensitivity settings	105
JPEG compression	94	Remote control mode	85
NEF (RAW) recording	94	Multiple exposure	160
White balance	115	Interval timer shooting	164
Set Picture Control	129	Time-lapse photography	168
Manage Picture Control	134	Movie settings	65
Auto distortion control	217		

**Note:** Depending on camera settings, some items may be grayed out and unavailable. For information on the options available in each shooting mode, see page 309.

## Reset Shooting Menu

MENU button →  shooting menu

Select **Yes** to restore shooting menu options to their default values ( 312).

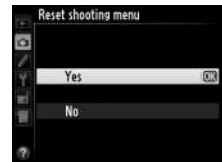

Select the folder in which subsequent images will be stored.

## ■ Selecting Folders by Folder Number

### 1 Choose Select folder by number.

Highlight **Select folder by number** and press ►.  
The dialog shown at right will be displayed.



### 2 Choose a folder number.

Press ◀ or ▶ to highlight a digit, press ▲ or ▼ to change. If a folder with the selected number already exists, a □, 📁, or 📁 icon will be displayed to the left of the folder number:

- □ : Folder is empty.
- 📁 : Folder is partially full.
- 📁 : Folder contains 999 pictures or a picture numbered 9999. No further pictures can be stored in this folder.

The card on which the folder is stored is shown by the card slot icon in the top right corner of the Select folder by number dialog. The card used for new folders depends on the option currently selected for **Role played by card in slot 2** (📁 96).

### 3 Save changes and exit.

Press **OK** to complete the operation and return to the shooting menu (to exit without choosing the storage folder, press the **MENU** button). If a folder with the specified number does not already exist, a new folder will be created.

Subsequent photographs will be stored in the selected folder unless it is already full.

#### Folder and File Numbers

If the current folder is numbered 999 and contains 999 pictures or a picture numbered 9999, the shutter-release will be disabled and no further photographs can be taken. To continue shooting, create a folder with a number less than 999, or select an existing folder with a number less than 999 and less than 999 images.

#### Startup Time

Additional time may be required for camera startup if the memory card contains a very large number of files or folders.



## ■ ■ Selecting Folders from a List

### 1 Choose **Select folder from list**.

Highlight **Select folder from list** and press ►.



### 2 Highlight a folder.

Press ▲ or ▼ to highlight a folder.

### 3 Select the highlighted folder.

Press **OK** to select the highlighted folder and return to the shooting menu. Subsequent photographs will be stored in the selected folder.

## File Naming

MENU button → shooting menu

Photographs are saved using file names consisting of “DSC\_” or, in the case of images that use the Adobe RGB color space, “\_DSC”, followed by a four-digit number and a three-letter extension (e.g., “DSC\_0001.JPG”). The **File naming** option is used to select three letters to replace the “DSC” portion of the file name. For information on editing file names, see page 135.

### Extensions

The following extensions are used: “.NEF” for NEF (RAW) images, “.JPG” for JPEG images, “.MOV” for movies, and “.NDF” for dust off reference data. In each pair of photographs recorded at image-quality settings of NEF (RAW)+JPEG, the NEF and JPEG images have the same file names but different extensions.

## Auto Distortion Control

MENU button →  shooting menu

Select **On** to reduce barrel distortion when shooting with wide-angle lenses and to reduce pin-cushion distortion when shooting with long lenses (note that the edges of the area visible in the viewfinder may be cropped out of the final photograph, and that the time needed to process photographs before recording begins may increase). This option does not apply to movies and is available only with type G, E, and D lenses (PC, fisheye, and certain other lenses excluded); results are not guaranteed with other lenses. Before using auto distortion control with DX lenses, select **On** for **Auto DX crop** or choose an image area of **DX (24×16) 1.5×** ( 90); selecting other options may result in heavily cropped photographs or in photographs with severe peripheral distortion.

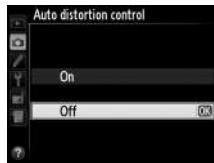

### **Retouch: Distortion Control**

For information on creating copies of existing photographs with reduced barrel and pin-cushion distortion, see page 274.

## Color Space

MENU button →  shooting menu

The color space determines the gamut of colors available for color reproduction. Choose **sRGB** for general-purpose printing and display; **Adobe RGB**, with its broader gamut of colors, is more suited to shots destined for professional publication and commercial printing.

### **Adobe RGB**

For accurate color reproduction, Adobe RGB images require applications, displays, and printers that support color management.

### **Color Space**

ViewNX 2 (supplied) and Capture NX 2 (available separately) automatically select the correct color space when opening photographs created with this camera. Results can not be guaranteed with third-party software.

### **Movies**

**sRGB** is recommended for movies.





## Vignette Control

MENU button →  shooting menu

“Vignetting” is a drop in brightness at the edges of a photograph. **Vignette control** reduces vignetting for type G, E, and D lenses (DX and PC lenses excluded). Its effects vary from lens to lens and are most noticeable at maximum aperture. Choose from **High, Normal, Low, and Off**.

### Vignette Control

Depending on the scene, shooting conditions, and type of lens, JPEG images may exhibit noise (fog) or variations in peripheral brightness, while custom Picture Controls and preset Picture Controls that have been modified from default settings may not produce the desired effect. Take test shots and view the results in the monitor. Vignette control does not apply to movies ( 57), multiple exposures ( 160), or DX-format images ( 89).

## Long Exposure NR (Long Exposure Noise Reduction)

MENU button →  shooting menu

If **On** is selected, photographs taken at shutter speeds slower than 1 s will be processed to reduce noise (bright spots, randomly-spaced bright pixels, or fog). The time required for processing roughly doubles; during processing, “**Job nr**” will flash in the shutter speed/aperture displays and pictures can not be taken (if the camera is turned off before processing is complete, the picture will be saved but noise reduction will not be performed). In continuous release mode, frame rates will slow and while photographs are being processed, the capacity of the memory buffer will drop. Long exposure noise reduction is not available during movie recording.

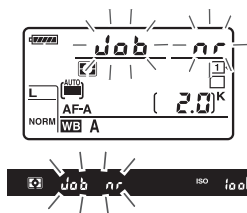

## High ISO NR

MENU button →  shooting menu

Photographs taken at high ISO sensitivities can be processed to reduce “noise.”

Option	Description
<b>High</b>	Reduce noise (randomly-spaced bright pixels, lines, or fog), particularly in photographs taken at high ISO sensitivities. Choose the amount of noise reduction performed from <b>High, Normal, and Low</b> .
<b>Normal</b>	
<b>Low</b>	
<b>Off</b>	Noise reduction is only performed at ISO sensitivities of ISO 2500 and higher. The amount of noise reduction is less than the amount performed when <b>Low</b> is selected for <b>High ISO NR</b> .



# Custom Settings: Fine-Tuning Camera Settings

To display the Custom Settings menu, press **MENU** and select the  (Custom Settings menu) tab.

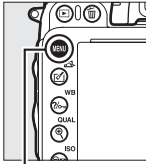

MENU button



Custom Settings are used to customize camera settings to suit individual preferences.

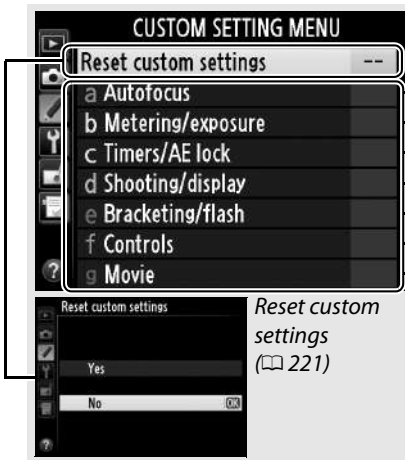

Custom Setting groups

Main menu



The following Custom Settings are available:

Custom Setting		
<b>Reset custom settings</b>		221
<b>a Autofocus</b>		
a1	AF-C priority selection	221
a2	AF-S priority selection	221
a3	Focus tracking with lock-on	222
a4	AF point illumination	222
a5	Focus point wrap-around	222
a6	Number of focus points	223
a7	Built-in AF-assist illuminator	223
<b>b Metering/exposure</b>		
b1	ISO sensitivity step value	224
b2	EV steps for exposure cntrl	224
b3	Easy exposure compensation	225
b4	Center-weighted area	226
b5	Fine-tune optimal exposure	226
<b>c Timers/AE lock</b>		
c1	Shutter-release button AE-L	226
c2	Standby timer	227
c3	Self-timer	227
c4	Monitor off delay	228
c5	Remote on duration	228
<b>d Shooting/display</b>		
d1	Beep	228
d2	Viewfinder grid display	229
d3	ISO display and adjustment	229
d4	Screen tips	229
d5	CL mode shooting speed	229
d6	Max. continuous release	230
d7	File number sequence	230
d8	Information display	231

Custom Setting		
<b>d Shooting/display</b>		
d9	LCD illumination	231
d10	Exposure delay mode	231
d11	Flash warning	231
d12	MB-D14 battery type	232
d13	Battery order	233
<b>e Bracketing/flash</b>		
e1	Flash sync speed	234
e2	Flash shutter speed	235
e3	Flash cntrl for built-in flash	236
e4	Exposure comp. for flash	240
e5	Modeling flash	241
e6	Auto bracketing set	241
e7	Bracketing order	241
<b>f Controls</b>		
f1	OK button (shooting mode)	241
f2	Assign Fn button	242
f3	Assign preview button	244
f4	Assign AE-L/AF-L button	244
f5	Customize command dials	245
f6	Release button to use dial	246
f7	Slot empty release lock	246
f8	Reverse indicators	246
f9	Assign MB-D14  button	247
<b>g Movie</b>		
g1	Assign Fn button	247
g2	Assign preview button	248
g3	Assign AE-L/AF-L button	248
g4	Assign shutter button	248

**Note:** Depending on camera settings, some items may be grayed out and unavailable. For information on the options available in each shooting mode, see page 309. If settings in the current bank have been modified from default values ( 313), an asterisk will be displayed adjacent to the altered settings in the second level of the Custom Settings menu.



## Reset Custom Settings

MENU button →  Custom Settings menu

Select **Yes** to restore Custom Settings to their default values (📖 313).





## a: Autofocus

### a1: AF-C Priority Selection

MENU button →  Custom Settings menu

When **AF-C** is selected for viewfinder photography (📖 97), this option controls whether photographs can be taken whenever the shutter-release button is pressed (*release priority*) or only when the camera is in focus (*focus priority*).



Option	Description
 <b>Release</b>	Photos can be taken whenever the shutter-release button is pressed.
 <b>Focus</b>	Photos can only be taken when the in-focus indicator (●) is displayed.

Regardless of the option selected, focus will not lock when **AF-C** is selected for autofocus mode. The camera will continue to adjust focus until the shutter is released.

### a2: AF-S Priority Selection

MENU button →  Custom Settings menu

When **AF-S** is selected for viewfinder photography (📖 97), this option controls whether photographs can be taken only when the camera is in focus (*focus priority*) or whenever the shutter-release button is pressed (*release priority*).

Option	Description
 <b>Release</b>	Photos can be taken whenever the shutter-release button is pressed.
 <b>Focus</b>	Photos can only be taken when the in-focus indicator (●) is displayed.





Regardless of the option selected, if the in-focus indicator (●) is displayed when **AF-S** is selected for autofocus mode, focus will lock while the shutter-release button is pressed halfway. Focus lock continues until the shutter is released.



### a3: Focus Tracking with Lock-On

MENU button →  Custom Settings menu

This option controls how autofocus adjusts to sudden large changes in the distance to the subject when AF-C is selected or continuous-servo autofocus is selected when the camera is in AF-A mode for viewfinder photography (□ 97).

Option	Description
AF  5 (Long)	When the distance to the subject changes abruptly, the camera waits for the specified period before adjusting the distance to the subject. This prevents the camera from refocusing when the subject is briefly obscured by objects passing through the frame.
AF  4	
AF  3 (Normal)	
AF  2	
AF  1 (Short)	
Off	The camera immediately adjusts focus when the distance to the subject changes. Use when photographing a series of subjects at varying distances in quick succession.

### a4: AF Point Illumination

MENU button →  Custom Settings menu



Choose whether the active focus point is highlighted in red in the viewfinder.

Option	Description
Auto	The selected focus point is automatically highlighted as needed to establish contrast with the background.
On	The selected focus point is always highlighted, regardless of the brightness of the background. Depending on the brightness of the background, the selected focus point may be difficult to see.
Off	The selected focus point is not highlighted. The area outside the current crop is shown in grey (□ 90).

### a5: Focus Point Wrap-Around

MENU button →  Custom Settings menu

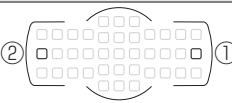

Choose whether focus-point selection “wraps around” from one edge of the viewfinder to another.

Option	Description
Wrap	Focus-point selection “wraps around” from top to bottom, bottom to top, right to left, and left to right, so that, for example, pressing  when a focus point at the right edge of the display is highlighted (①) selects the corresponding focus point at the left edge of the display (②). 
No wrap	The focus-point display is bounded by the outermost focus points so that, for example, pressing  when a focus point at the right edge of the display is selected has no effect.

## a6: Number of Focus Points

MENU button →  Custom Settings menu

Choose the number of focus points available for manual focus-point selection.



Option	Description	
AF39 <b>39 points</b>	Choose from the 39 focus points shown at right.	
AF11 <b>11 points</b>	Choose from the 11 focus points shown at right. Use for quick focus-point selection.	

## a7: Built-in AF-assist Illuminator

MENU button →  Custom Settings menu

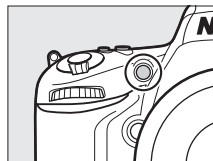
Choose whether the built-in AF-assist illuminator lights to assist the focus operation when lighting is poor.



Option	Description
<b>On</b>	The AF-assist illuminator lights when lighting is poor (viewfinder photography only). AF-assist illumination is only available when both of the following conditions are met: <ol style="list-style-type: none"><li>1. <b>AF-S</b> is selected for autofocus mode ( 97) or single-servo autofocus is selected when the camera is in <b>AF-A</b> mode.</li><li>2. Auto-area AF is chosen for AF-area mode ( 99), or an option other than auto-area AF is chosen and the center focus point is selected.</li></ol>
<b>Off</b>	The AF-assist illuminator does not light to assist the focus operation. The camera may not be able to focus using autofocus when lighting is poor.

### The AF-Assist Illuminator

The AF-assist illuminator has a range of about 0.5–3.0 m (1 ft 8 in.–9 ft 10 in.); when using the illuminator, remove the lens hood.

### See Also

For information on the shooting modes in which AF-assist is available, see page 309. See page 290 for restrictions on the lenses that can be used with AF assist.



## b: Metering/Exposure

### b1: ISO Sensitivity Step Value

MENU button →  Custom Settings menu

Select the increments used when making adjustments to ISO sensitivity. If possible, the current ISO sensitivity setting is maintained when the step value is changed. If the current setting is not available at the new step value, ISO sensitivity will be rounded to the nearest available setting.

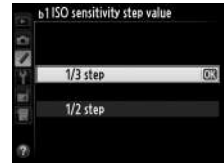

### b2: EV Steps for Exposure Cntrl

MENU button →  Custom Settings menu

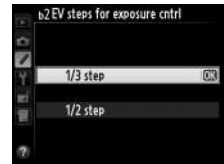

Select the increments used when making adjustments to shutter speed, aperture, exposure and flash compensation, and bracketing.



## b3: Easy Exposure Compensation

MENU button →  Custom Settings menu

This option controls whether the  button is needed to set exposure compensation (□ 112). If **On (Auto reset)** or **On** is selected, the 0 at the center of the exposure display will flash even when exposure compensation is set to  $\pm 0$ .

Option	Description
<b>On (Auto reset)</b>	Exposure compensation is set by rotating one of the command dials (see note below). The setting selected using the command dial is reset when the camera turns off or the standby timer expires (exposure compensation settings selected using the  button are not reset).
<b>On</b>	As above, except that the exposure compensation value selected using the command dial is not reset when the camera turns off or the standby timer expires.
<b>Off</b>	Exposure compensation is set by pressing the  button and rotating the main command dial.

### Change Main/Sub

The dial used to set exposure compensation when **On (Auto reset)** or **On** is selected for Custom Setting b3 (**Easy exposure compensation**) depends on the option selected for Custom Setting f5 (**Customize command dials**) > **Change main/sub** (□ 245).

Customize command dials > Change main/sub			
	Off	On	
Mode	P	Sub-command dial	Sub-command dial
	S	Sub-command dial	Main command dial
	A	Main command dial	Sub-command dial
	M	N/A	

### Show ISO/Easy ISO

Custom Setting b3 (**Easy exposure compensation**) can not be used with Custom Setting d3 (**Show ISO/Easy ISO**). Adjustments to either of these items reset the remaining item; a message is displayed when the item is reset.



## b4: Center-Weighted Area

MENU button →  Custom Settings menu

When calculating exposure, center-weighted metering assigns the greatest weight to a circle in the center of the frame. The diameter ( $\phi$ ) of this circle can be set to 8, 12, 15, or 20 mm or to the average of the entire frame.



Note that unless **Average** is selected, the diameter is fixed at 12 mm when a non-CPU lens is used, regardless of the setting selected for **Non-CPU lens data** in the setup menu (📖 172). When **Average** is selected, the average of the entire frame will be used for both CPU and non-CPU lenses.

## b5: Fine-tune Optimal Exposure

MENU button →  Custom Settings menu

Use this option to fine-tune the exposure value selected by the camera. Exposure can be fine-tuned separately for each metering method by from +1 to -1 EV in steps of  $1/6$  EV.

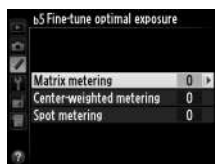

### Fine-Tuning Exposure

Exposure fine-tuning is not affected by two-button resets. Note that as the exposure compensation (☒) icon is not displayed, the only way to determine how much exposure has been altered is to view the amount in the fine-tuning menu. Exposure compensation (📖 112) is preferred in most situations.

## c: Timers/AE Lock

### c1: Shutter-Release Button AE-L

MENU button →  Custom Settings menu

If **On** is selected, exposure will lock when the shutter-release button is pressed halfway.

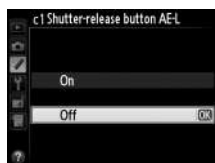



## c2: Standby timer

MENU button →  Custom Settings menu

Choose how long the camera continues to meter exposure when no operations are performed. The shutter-speed and aperture displays in the control panel and viewfinder turn off automatically when the timer expires.

Choose a shorter standby timer delay for longer battery life.



## c3: Self-Timer

MENU button →  Custom Settings menu

Choose the length of the shutter release delay, the number of shots taken, and the interval between shots in self-timer mode.

- **Self-timer delay:** Choose the length of the shutter-release delay (☞ 85).
- **Number of shots:** Press ▲ and ▼ to choose the number of shots taken each time the shutter-release button is pressed.
- **Interval between shots:** Choose the interval between shots when the **Number of shots** is more than 1.

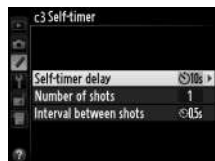

## c4: Monitor off Delay

MENU button →  Custom Settings menu

Choose how long the monitor remains on when no operations are performed during playback (**Playback**; defaults to 10 s) and image review (**Image review**; defaults to 4 s), when menus (**Menus**; defaults to 1 minute) or information (**Information display**; defaults to 10 s) are displayed, or during live view and movie recording (**Live view**; defaults to 10 minutes). Choose a shorter monitor-off delay for longer battery life.

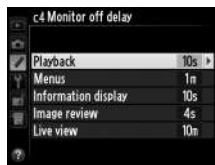

## c5: Remote on Duration

MENU button →  Custom Settings menu

Choose how long the camera will remain on stand-by in remote release mode (☐ 85). If no operations are performed for the selected period, remote shooting will end and the exposure meters will turn off. Choose shorter times for longer battery life. To reactivate remote control mode after the timer has expired, press the camera shutter-release button halfway.

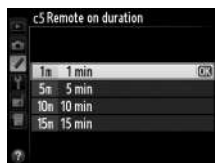

## d: Shooting/Display

### d1: Beep

MENU button →  Custom Settings menu

Choose the pitch and volume of the beep that sounds when the camera focuses using single-servo AF (**AF-S** or when single-servo AF is selected for **AF-A**; ☐ 97), when focus locks during live view photography, while the release timer is counting down in self-timer and delayed remote release modes (☐ 85), when a photograph is taken in quick-response remote or remote mirror-up mode (☐ 85), when time-lapse photography ends (☐ 168), or if you attempt to take a photograph when the memory card is locked (☐ 32). Note that a beep will not sound in movie live view (☐ 57) or quiet-shutter release mode (modes **Q** and **Qc**; ☐ 83), regardless of the option selected.

- **Volume:** Choose **3** (high), **2** (medium), **1** (low) or **Off** (mute).  
When an option other than **Off** is selected,  appears in the information display.
- **Pitch:** Choose **High** or **Low**.

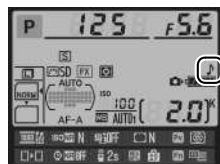

## d2: Viewfinder Grid Display

MENU button →  Custom Settings menu

Choose **On** to display on-demand grid lines in the viewfinder for reference when composing photographs (□ 8).

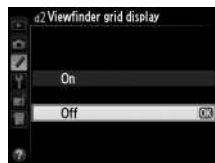

## d3: ISO Display and Adjustment

MENU button →  Custom Settings menu

If **Show ISO sensitivity** or **Show ISO/Easy ISO** is selected, the control panel will show ISO sensitivity in place of the number of exposures remaining. If **Show ISO/Easy ISO** is selected, ISO sensitivity can be set in modes **P** and **S** by rotating the sub-command dial or in mode **A** by rotating the main command dial. Select **Show frame count** to display the number of exposures remaining in the control panel.

## d4: Screen Tips

MENU button →  Custom Settings menu

Choose **On** to display tool tips for items selected in the information display (□ 11).

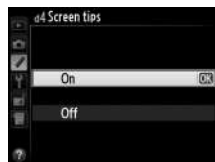

## d5: CL Mode Shooting Speed

MENU button →  Custom Settings menu

Choose the maximum frame advance rate in **CL** (continuous low speed) mode (□ 83; during interval timer photography, this setting also determines the frame advance rate for single-frame).

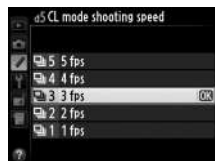

## d6: Max. Continuous Release

MENU button →  Custom Settings menu

The maximum number of shots that can be taken in a single burst in continuous mode can be set to any value between 1 and 100.

### The Memory Buffer

Regardless of the option selected for Custom Setting d6, shooting will slow when the memory buffer fills (P00). See page 335 for more information on the capacity of the memory buffer.

## d7: File Number Sequence

MENU button →  Custom Settings menu

When a photograph is taken, the camera names the file by adding one to the last file number used. This option controls whether file numbering continues from the last number used when a new folder is created, the memory card is formatted, or a new memory card is inserted in the camera.

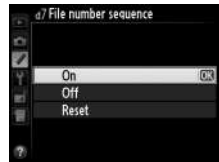

Option	Description
<b>On</b>	When a new folder is created, the memory card formatted, or a new memory card inserted in the camera, file numbering continues from the last number used or from the largest file number in the current folder, whichever is higher. If a photograph is taken when the current folder contains a photograph numbered 9999, a new folder will be created automatically and file numbering will begin again from 0001.
<b>Off</b>	File numbering is reset to 0001 when a new folder is created, the memory card is formatted, or a new memory card is inserted in the camera. Note that a new folder is created automatically if a photograph is taken when the current folder contains 999 photographs.
<b>Reset</b>	As for <b>On</b> , except that the next photograph taken is assigned a file number by adding one to the largest file number in the current folder. If the folder is empty, file numbering is reset to 0001.

### File Number Sequence

If the current folder is numbered 999 and contains either 999 photographs or a photograph numbered 9999, the shutter-release button will be disabled and no further photographs can be taken. Choose **Reset** for Custom Setting d7 (**File number sequence**) and then either format the current memory card or insert a new memory card.

## d8: Information Display

MENU button →  Custom Settings menu

If **Auto** (AUTO) is selected, the color of the lettering in the information display (☐ 9) will automatically change from black to white or white to black to maintain contrast with the background. To always use the same color lettering, select **Manual** and choose **Dark on light** (B; black lettering) or **Light on dark** (W; white lettering). Monitor brightness will automatically be adjusted for maximum contrast with the selected text color.



Dark on light



Light on dark

## d9: LCD Illumination

MENU button →  Custom Settings menu

If **Off** is selected, the control panel backlight (LCD illuminator) will only light while the power switch is rotated toward . If **On** is selected, the control panel will be illuminated whenever the standby timer is active (☐ 39). Select **Off** for increased battery life.



## d10: Exposure Delay Mode

MENU button →  Custom Settings menu

In situations where the slightest camera movement can blur pictures, select **1 s**, **2 s**, or **3 s** to delay shutter release until one, two, or three seconds after the mirror is raised.



## d11: Flash Warning

MENU button →  Custom Settings menu



If **On** is selected, the flash-ready indicator () will flash in the viewfinder if the flash is required to ensure optimal exposure.



## d12: MB-D14 Battery Type





MENU button →  Custom Settings menu

To ensure that the camera functions as expected when the optional MB-D14 battery pack is used with AA batteries, match the option selected in this menu to the type of batteries inserted in the battery pack. There is no need to adjust this option when using EN-EL15 batteries.

Option	Description
 LR6 (AA alkaline)	Select when using LR6 alkaline AA batteries.
 HR6 (AA Ni-MH)	Select when using HR6 Ni-MH AA batteries.
 FR6 (AA lithium)	Select when using FR6 lithium AA batteries.

### Using AA Batteries

The capacity of AA batteries drops sharply at temperatures below 20 °C (68 °F) and varies with make and storage conditions; in some cases, batteries may cease to function before their expiry date. Some AA batteries can not be used; due to their performance characteristics and limited capacity, alkaline batteries have less capacity than some other types and should only be used if no alternative is available and then only at warmer temperatures. The camera shows the level of AA batteries as follows:

Control panel	Viewfinder	Description
	—	Batteries fully charged.
		Low battery. Ready fresh batteries.
 (flashes)	 (flashes)	Shutter release disabled. Change batteries.

## d13: Battery Order

MENU button →  Custom Settings menu

Choose whether the battery in the camera or the batteries in the battery pack are used first when an optional MB-D14 battery pack is attached. Note that if the MB-D14 is powered by an optional EH-5b AC adapter and EP-5B power connector, the AC adapter will be used regardless of the option selected.



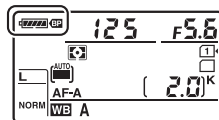

A  icon is displayed in the camera control panel when the batteries in the MB-D14 are in use.



### The MB-D14 Battery Pack

The MB-D14 takes one EN-EL15 rechargeable Li-ion battery or six AA alkaline, Ni-MH, or lithium batteries (an EN-EL15 is supplied with the camera; AA batteries are available separately).

The information display shows the type of battery inserted in the MB-D14 as follows:

MB-D14 battery type display	Battery type
	EN-EL15 rechargeable Li-ion battery
	AA batteries



## e: Bracketing/Flash

### e1: Flash Sync Speed

MENU button →  Custom Settings menu

This option controls flash sync speed.

Option	Description
<b>1/250 s</b> (Auto FP)	Auto FP high-speed sync is used when a compatible flash unit is attached (☐ 294). If the built-in flash or other flash units are used, shutter speed is set to 1/250 s. When the camera shows a shutter speed of 1/250 s in mode <b>P</b> or <b>A</b> , auto FP high-speed sync will be activated if the actual shutter speed is faster than 1/250 s.
<b>1/200 s</b> (Auto FP)	Auto FP high-speed sync is used when a compatible flash unit is attached (☐ 294). If the built-in flash or other flash units are used, shutter speed is set to 1/200 s. When the camera shows a shutter speed of 1/200 s in mode <b>P</b> or <b>A</b> , auto FP high-speed sync will be activated if the actual shutter speed is faster than 1/200 s.
<b>1/200 s–1/60 s</b>	Flash sync speed set to selected value.

#### **Fixing Shutter Speed at the Flash Sync Speed Limit**

To fix shutter speed at the sync speed limit in mode **S** or **M**, select the next shutter speed after the slowest possible shutter speed (30 s or bulb). An X (flash sync indicator) will be displayed in the viewfinder and control panel.

#### **Auto FP High-Speed Sync**

Allows the flash to be used at the highest shutter speed supported by the camera, making it possible to choose the maximum aperture for reduced depth of field even when the subject is backlit in bright sunlight. The information display flash mode indicator shows “FP” when auto FP high-speed sync is active (☐ 295).



## ■ Auto FP High-Speed Sync

When **1/250 s (Auto FP)** or **1/200 s (Auto FP)** is selected for Custom Setting e1 (**Flash sync speed**, □ 234), the built-in flash can be used at shutter speeds as fast as  $1/250$  s or  $1/200$  s, while compatible optional flash units (□ 294) can be used at any shutter speed (Auto FP High-Speed Sync).

Flash sync speed \ Shutter speed	1/250 s (Auto FP)		1/200 s (Auto FP)		1/200 s	
	Built-in flash	Optional flash unit	Built-in flash	Optional flash unit	Built-in flash	Optional flash unit
From $1/4,000$ to but not including $1/250$ s	—	Auto FP	—	Auto FP	—	—
From $1/250$ to but not including $1/200$ s	Flash sync *		—	Auto FP	—	—
$1/200$ –30 s	Flash sync					

\* Flash range drops as shutter speed increases. Flash range will nevertheless be greater than that obtained at the same speeds with Auto FP.

## e2: Flash Shutter Speed

MENU button →  Custom Settings menu

This option determines the slowest shutter speed available when using front- or rear-curtain sync or red-eye reduction in mode **P** or **A** (regardless of the setting chosen, shutter speeds can be as slow as 30 s in **S** and **M** modes or at flash settings of slow sync, slow rear-curtain sync, or red-eye reduction with slow sync). Options range from  $1/60$  s (**1/60 s**) to 30 s (**30 s**).



## e3: Flash Cntrl for Built-in Flash

MENU button → Custom Settings menu

Choose the flash mode for the built-in flash.

Option	Description
TTL	Flash output is adjusted automatically in response to shooting conditions.
Manual	Choose the flash level (□ 236). The camera does not emit monitor pre-flashes.
RPT  Repeating flash	The flash fires repeatedly while the shutter is open, producing a strobe-light effect (□ 236).
CMD  Commander mode	Use the built-in flash as a master flash controlling remote optional flash units in one or more groups (□ 237).

### Manual

Choose a flash level between **Full** and **1/128** ( $1/128$  of full power). At full power, the built-in flash has a Guide Number of 12/39 (m/ft, ISO 100, 20°C/68°F).

### Repeating Flash

The flash fires repeatedly while the shutter is open, producing a strobe-light effect. Press ◀ or ▶ to highlight the following options, ▲ or ▼ to change.

Option	Description
<b>Output</b>	Choose flash output (expressed as a fraction of full power).
<b>Times</b>	Choose the number of times the flash fires at the selected output. Note that depending on shutter speed and the option selected for <b>Frequency</b> , the actual number of flashes may be less than selected.
<b>Frequency</b>	Choose how often the flash fires per second.



### Flash Control Mode

The flash control mode for the built-in flash is shown in the information display (□ 146).



### "Manual" and "Repeating Flash"

icons flash in the control panel and viewfinder when these options are selected.

## The SB-400 and SB-300

When an optional SB-400 or SB-300 flash unit is attached and turned on, Custom Setting e3 changes to **Optional flash**, allowing the flash control mode for the optional flash unit to be selected from **TTL** and **Manual** (**Repeating flash** and **Commander mode** options are not available).

## “Times”

The options available for **Repeating Flash > Times** are determined by flash output.

Output	Options available for “Times”	Output	Options available for “Times”
1/4	2	1/32	2–10, 15
1/8	2–5	1/64	2–10, 15, 20, 25
1/16	2–10	1/128	2–10, 15, 20, 25, 30, 35

## Commander Mode

Use the built-in flash as a master flash controlling one or more remote optional flash units in up to two groups (A and B) using advanced wireless lighting (📖 294).

Selecting this option displays the menu shown at right. Press ◀ or ▶ to highlight the following options, ▲ or ▼ to change.



Option	Description
<b>Built-in flash</b>	Choose a flash mode for the built-in flash (commander flash).
<b>TTL</b>	i-TTL mode. Choose flash compensation from values between +3.0 and –3.0 EV in increments of 1/3 EV.
<b>M</b>	Choose the flash level from values between <b>1/1</b> and <b>1/128</b> (1/128 of full power).
<b>--</b>	The built-in flash does not fire, although remote flash units do. The built-in flash must be raised so that it can emit monitor pre-flashes.
<b>Group A</b>	Choose a flash mode for all flash units in group A.
<b>TTL</b>	i-TTL mode. Choose flash compensation from values between +3.0 and –3.0 EV in increments of 1/3 EV.
<b>AA</b>	Auto aperture (available only with compatible flash units; 📖 294). Choose flash compensation from values between +3.0 and –3.0 EV in increments of 1/3 EV.
<b>M</b>	Choose the flash level from values between <b>1/1</b> and <b>1/128</b> (1/128 of full power).
<b>--</b>	The flash units in this group do not fire.
<b>Group B</b>	Choose a flash mode for all flash units in group B. The options available are the same as those listed for <b>Group A</b> , above.
<b>Channel</b>	Choose from channels 1–4. All flash units in both groups must be set to the same channel.



Follow the steps below to take photographs in commander mode.

## 1 Adjust settings for the built-in flash.

Choose the flash control mode and output level for the built-in flash. Note that output level can not be adjusted in -- mode.

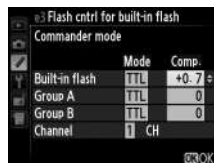

## 2 Adjust settings for group A.

Choose the flash control mode and output level for the flash units in group A.



## 3 Adjust settings for group B.

Choose the flash control mode and output level for the flash units in group B.

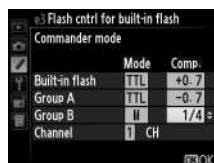

## 4 Select the channel.

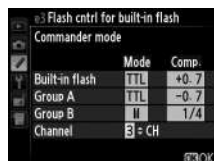

## 5 Press **OK**.

---

## 6 Compose the shot.

Compose the shot and arrange the flash units as shown below. Note that the maximum distance at which the remote flash units can be placed may vary with shooting conditions.

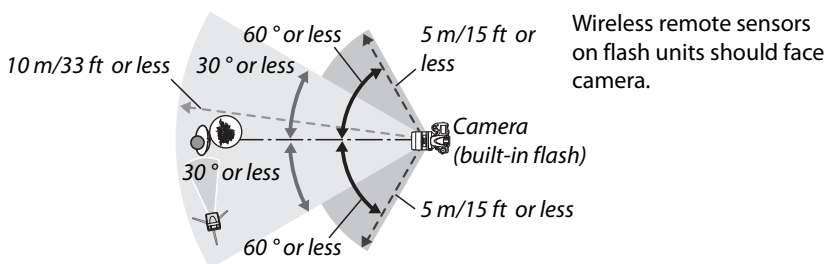



---

## 7 Configure the remote flash units.

Turn all the remote flash units on, adjust group settings as desired, and set them to the channel selected in Step 4. See the flash unit instruction manuals for details.

---

## 8 Raise the built-in flash.

Press the  () button to raise the built-in flash. Note that even if -- is selected for **Built-in flash > Mode**, the built-in flash must be raised so that monitor preflashes will be emitted.

---





## 9 Frame the photograph, focus, and shoot.

After confirming that the camera flash-ready light and the flash-ready lights for all other flash units are lit, frame the photograph, focus, and shoot. FV lock ( 149) can be used if desired.

### **The Flash Sync Mode Display**

 does not appear in the control panel flash sync mode display when -- is selected for **Built-in flash > Mode**.

### **Flash Compensation**

The flash compensation value selected with the  () button and sub-command dial is added to the flash compensation values selected for the built-in flash, group A, and group B in the **Commander mode** menu. A  icon is displayed in the control panel and viewfinder when a flash compensation value other than  $\pm 0$  is selected for **Built-in flash > TTL**. The  icon flashes when the built-in flash is in mode **M**.

### **Commander Mode**



Position the sensor windows on the remote flash units to pick up the light from the built-in flash (particular care is required if the camera is not mounted on a tripod). Be sure that direct light or strong reflections from the remote flash units do not enter the camera lens (in TTL mode) or the photocells on the remote flash units (AA mode), as this may interfere with exposure. To prevent timing flashes emitted by the built-in flash from appearing in photographs taken at short range, choose low ISO sensitivities or small apertures (high f-numbers) or use an optional SG-3IR infrared panel for the built-in flash. An SG-3IR is required for best results with rear-curtain sync, which produces brighter timing flashes. After positioning the remote flash units, take a test shot and view the results in the camera monitor.

Although there is no limit on the number of remote flash units that may be used, the practical maximum is three. With more than this number, the light emitted by the remote flash units will interfere with performance.

## **e4: Exposure Comp. for Flash**

MENU button →  Custom Settings menu

Choose how the camera adjusts flash level when exposure compensation is used.

Option	Description
 <b>Entire frame</b>	Both flash level and exposure compensation are adjusted to modify exposure over the entire frame.
 <b>Background only</b>	Exposure compensation applies to background only.

## e5: Modeling Flash

MENU button →  Custom Settings menu

If **On** is selected when the camera is being used with the built-in flash or an optional CLS-compatible flash unit (□ 294), a modeling flash will be emitted when the camera depth-of-field preview button is pressed (□ 77). No modeling flash is emitted if **Off** is selected.

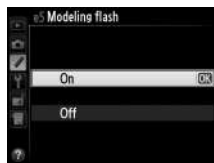

## e6: Auto Bracketing Set

MENU button →  Custom Settings menu

Choose the setting or settings bracketed when auto bracketing (□ 153) is in effect. Choose **AE & flash** (AE) to perform both exposure and flash-level bracketing, **AE only** (AE) to bracket only exposure, **Flash only** (f) to perform only flash-level bracketing, **WB bracketing** (WB) to perform white-balance bracketing (□ 156), or **ADL bracketing** (ADL) to perform bracketing using Active D-Lighting (□ 158). Note that white balance bracketing is not available at image quality settings of NEF (RAW) or NEF (RAW) + JPEG.

## e7: Bracketing Order

MENU button →  Custom Settings menu

At the default setting of **MTR > under > over** (MTR), exposure, flash, and white balance bracketing are performed in the order described on pages 153 and 156. If **Under > MTR > over** (→+) is selected, shooting will proceed in order from the lowest to the highest value. This setting has no effect on ADL bracketing.

## f: Controls

### f1: OK Button (Shooting Mode)

MENU button →  Custom Settings menu

Choose the role played by the  button during shooting: selecting the center focus point (RESET **Select center focus point**), highlighting the active focus point (⇨ **Highlight active focus point**), or none (**Not used**).









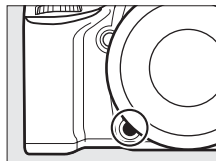







## f2: Assign Fn Button











MENU button →  Custom Settings menu

Choose the role played by the **Fn** button.









Option	Description
 <b>Preview</b>	Press the <b>Fn</b> button to preview depth of field (□ 77).
 <b>FV lock</b>	Press the <b>Fn</b> button to lock flash value (built-in flash and compatible optional flash units only, □ 149, 294). Press again to cancel FV lock.
 <b>AE/AF lock</b>	Focus and exposure lock while the <b>Fn</b> button is pressed.
 <b>AE lock only</b>	Exposure locks while the <b>Fn</b> button is pressed.
 <b>AE lock (Hold)</b>	Exposure locks when the <b>Fn</b> button is pressed, and remains locked until the button is pressed a second time or the standby timer expires.
 <b>AF lock only</b>	Focus locks while the <b>Fn</b> button is pressed.
 <b>AF-ON</b>	Pressing the <b>Fn</b> button initiates autofocus. The shutter-release button can not be used to focus.
 <b>Flash off</b>	The flash will not fire in photos taken while the <b>Fn</b> button is pressed.
 <b>Bracketing burst</b>	If the <b>Fn</b> button is pressed while exposure, flash, or ADL bracketing is active in single frame or quiet shutter-release mode, all shots in the current bracketing program will be taken each time the shutter-release button is pressed. If white balance bracketing is active or continuous release mode (mode <b>Ch</b> , <b>Cl</b> , or <b>Qc</b> ) is selected, the camera will repeat the bracketing burst while the shutter-release button is held down.
 <b>Active D-Lighting</b>	Press the <b>Fn</b> button and rotate the main command dial to adjust Active D-Lighting (□ 137).
 <b>+NEF (RAW)</b>	If image quality is set to <b>JPEG fine</b> , <b>JPEG normal</b> , or <b>JPEG basic</b> , “RAW” will be displayed in the control panel and an NEF (RAW) copy will be recorded with the next picture taken after the <b>Fn</b> button is pressed (to record NEF/RAW copies with a series of photographs, keep the shutter-release button pressed halfway between shots). To exit without recording an NEF (RAW) copy, press the <b>Fn</b> button again.
 <b>Matrix metering</b>	Matrix metering is activated while the <b>Fn</b> button is pressed.
 <b>Center-weighted metering</b>	Center-weighted metering is activated while the <b>Fn</b> button is pressed.
 <b>Spot metering</b>	Spot metering is activated while the <b>Fn</b> button is pressed.

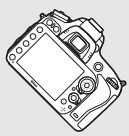

Option	Description
 <b>Framing grid</b>	Press the <b>Fn</b> button and rotate the main command dial to turn the framing grid display in the viewfinder on or off (☞ 8).
 <b>Choose image area</b>	Press the <b>Fn</b> button and rotate a command dial to choose an image area (☞ 89).
 <b>Viewfinder virtual horizon</b>	Press the <b>Fn</b> button to view a virtual horizon display in the viewfinder.
 <b>MY MENU</b>	Pressing the <b>Fn</b> button displays “MY MENU” (☞ 280).
 <b>Access top item in MY MENU</b>	Press the <b>Fn</b> button to jump to the top item in “MY MENU.” Select this option for quick access to a frequently-used menu item.
 <b>1 step spd/aperture</b>	If the <b>Fn</b> button is pressed when the command dials are rotated, changes to shutter speed (modes <b>S</b> and <b>M</b> ) and aperture (modes <b>A</b> and <b>M</b> ) are made in increments of 1 EV, regardless of the option selected for Custom Setting b2 ( <b>EV steps for exposure ctrl</b> , ☞ 224).
 <b>Choose non-CPU lens number</b>	Press the <b>Fn</b> button and rotate a command dial to choose a lens number specified using the <b>Non-CPU lens data</b> option (☞ 172).
 <b>Playback</b>	<b>Fn</b> button performs same function as  button. Select when using a telephoto lens or in other circumstances in which it is difficult to operate the  button with your left hand.
<b>None</b>	Pressing the button has no effect.

### **Viewfinder Virtual Horizon**

When **Viewfinder virtual horizon** is selected for Custom Setting f2 (**Assign Fn button**), pressing the **Fn** button converts the exposure display in the viewfinder to a roll indicator. Press the button again to restore the indicator to its normal function.

	Camera tilted right	Camera level	Camera tilted left
			
<b>Viewfinder</b>			

Note that the display may not be accurate when the camera is tilted at a sharp angle forward or back. For a display that shows both pitch and roll, use the **Virtual horizon** option in the setup menu (☞ 258).



### f3: Assign Preview Button

MENU button →  Custom Settings menu



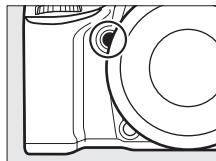









Choose the role played by the depth-of-field preview button. The options available are the same as for **Assign Fn button** (□ 242). The default setting is **Preview**.



### f4: Assign AE-L/AF-L Button

MENU button →  Custom Settings menu

Choose the role played by the  **AE-L/AF-L** button.

Option	Description
 <b>AE/AF lock</b>	Focus and exposure lock while the  <b>AE-L/AF-L</b> button is pressed.
 <b>AE lock only</b>	Exposure locks while the  <b>AE-L/AF-L</b> button is pressed.
 <b>AE lock (Hold)</b>	Exposure locks when the  <b>AE-L/AF-L</b> button is pressed, and remains locked until the button is pressed a second time or the standby timer expires.
 <b>AF lock only</b>	Focus locks while the  <b>AE-L/AF-L</b> button is pressed.
 <b>AF-ON</b>	The  <b>AE-L/AF-L</b> button initiates autofocus. The shutter-release button can not be used to focus.
 <b>FV lock</b>	Press the  <b>AE-L/AF-L</b> button to lock flash value (built-in flash and compatible optional flash units only, □ 149, 294). Press again to cancel FV lock.
<b>None</b>	Pressing the button has no effect.

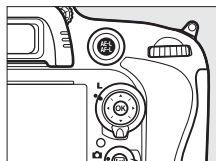





This option controls the operation of the main and sub-command dials.

- Reverse rotation:** Reverse the direction of rotation of the command dials when they are used to make adjustments to **Exposure compensation** and/or **Shutter speed/aperture**. Highlight options and press the multi selector right to select or deselect, then highlight **Done** and press **OK**. This setting also applies to the command dials for the MB-D14.
 
- Change main/sub:** If **Off** is selected, the main command dial controls shutter speed and the sub-command dial controls aperture. Select **On (Mode A)** to use the main command dial to select aperture in shooting mode **A**, **On** to use the main command dial to select aperture in modes **A** and **M** and the sub-command dial to select shutter speed in modes **S** and **M**. This setting also applies to the command dials for the MB-D14.
 
- Aperture setting:** If **Sub-command dial** is selected, aperture can only be adjusted with the sub-command dial (or with the main command dial if **On** is selected for **Change main/sub**). If **Aperture ring** is selected, aperture can only be adjusted with the lens aperture ring and the camera aperture display will show aperture in increments of 1 EV (aperture for type G, E lenses is still set using the sub-command dial). Note that regardless of the setting chosen, the aperture ring must be used to adjust aperture when a non-CPU lens is attached.
- Menus and playback:** If **Off** is selected, the multi selector is used to choose the picture displayed during full-frame playback, highlight thumbnails, and navigate menus. If **On** or **On (image review excluded)** is selected, the main command dial can be used to choose the picture displayed during full-frame playback, move the cursor left or right during thumbnail playback, and move the menu highlight bar up or down. The sub-command dial is used to display additional photo information in full-frame playback and to move the cursor up or down during thumbnail playback. Select **On (image review excluded)** to prevent the command dials from being used for playback during image review. While menus are displayed, rotating the sub-command dial right displays the sub-menu for the selected option, while rotating it left displays the previous menu. To make a selection, press **▶** or **OK**.

## f6: Release Button to Use Dial

MENU button →  Custom Settings menu

Selecting **Yes** allows adjustments that are normally made by holding the ,  (**ISO**),  (**QUAL**),  (**WB**), AF-mode,  (**FORMAT**), or **BKT** button and rotating a command dial to be made by rotating the command dial after the button is released (this also applies to the **Fn** and depth-of-field preview buttons if they have been assigned **Active D-Lighting** using Custom Setting f2, **Assign Fn button**, or Custom Setting f3, **Assign preview button**). Setting ends when any of the affected buttons is pressed again or the shutter-release button is pressed halfway. Except when **No limit** is selected for Custom Setting c2 **Standby timer**, setting will also end when the standby timer expires.



## f7: Slot Empty Release Lock

MENU button →  Custom Settings menu

Selecting **Enable release** allows the shutter to be released when no memory card is inserted, although no pictures will be recorded (they will however be displayed in the monitor in demo mode). If **Release locked** is selected, the shutter-release button is only enabled when a memory card is inserted in the camera.

## f8: Reverse Indicators

MENU button →  Custom Settings menu









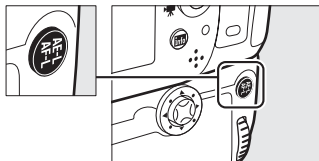





If  (**-0+**) is selected, the exposure indicators in the control panel, viewfinder, and information display are displayed with negative values on the left and positive values on the right. Select  (**+0-**) to display positive values on the left and negative values on the right.

## f9: Assign MB-D14 Button

MENU button →  Custom Settings menu

Choose the function assigned to the  **AE-L/AF-L** button on the optional MB-D14 battery pack.









Option	Description
 <b>AE/AF lock</b>	Focus and exposure lock while the MB-D14  <b>AE-L/AF-L</b> button is pressed.
 <b>AE lock only</b>	Exposure locks while the MB-D14  <b>AE-L/AF-L</b> button is pressed.
 <b>AE lock (Hold)</b>	Exposure locks when the MB-D14  <b>AE-L/AF-L</b> button is pressed, and remains locked until the button is pressed a second time or the standby timer expires.
 <b>AF lock only</b>	Focus locks while the MB-D14  <b>AE-L/AF-L</b> button is pressed.
 <b>AF-ON</b>	Pressing the MB-D14  <b>AE-L/AF-L</b> button initiates autofocus. The shutter-release button can not be used to focus.
 <b>FV lock</b>	Press the MB-D14  <b>AE-L/AF-L</b> button to lock flash value (built-in flash and compatible optional flash units only, □ 149, 294). Press again to cancel FV lock.
 <b>Same as Fn button</b>	The MB-D14  <b>AE-L/AF-L</b> button performs the function selected for Custom Setting f2 (□ 242).

## g: Movie

### g1: Assign Fn Button

MENU button →  Custom Settings menu

Choose the role played by the **Fn** button during movie live view (the default option is **None**).

Option	Description
 <b>Index marking</b>	Press the button during movie recording to add an index at the current position (□ 60). Indices can be used when viewing and editing movies.
 <b>View photo shooting info</b>	Press the button to display information on shutter speed, aperture, and other photo settings in place of movie recording information. Press again to return to the movie recording display (□ 59).
 <b>AE/AF lock</b>	Focus and exposure lock while the button is pressed.
 <b>AE lock only</b>	Exposure locks while the button is pressed.
 <b>AE lock (Hold)</b>	Exposure locks when the button is pressed, and remains locked until the button is pressed a second time or the standby timer expires.
 <b>AF lock only</b>	Focus locks while the button is pressed.
 <b>AF-ON</b>	Pressing the button initiates autofocus. The shutter-release button can not be used to focus.
<b>None</b>	Pressing the button has no effect.



## g2: Assign Preview Button

MENU button →  Custom Settings menu

Choose the role played by the depth-of-field preview button during movie live view. The options available are the same as for **Assign Fn button** (□ 247), except that the default setting is **Index marking**.

## g3: Assign AE-L/AF-L Button





MENU button →  Custom Settings menu

Choose the role played by the <sup>AE-L</sup>/<sub>AF-L</sub> AE-L/AF-L button during movie live view. The options available are the same as for **Assign Fn button** (□ 247), except that the default setting is **AE/AF lock**.

## g4: Assign Shutter Button

MENU button →  Custom Settings menu

Choose the role played by pressing the shutter-release button when  is selected with the live view selector.

Option	Description
 <b>Take photos</b>	Press the shutter-release button all the way down to end movie recording and take a photograph with an aspect ratio of 16 : 9 (for information on image size, see page 63).
 <b>Record movies</b>	Press the shutter-release button halfway to start movie live view. You can then press the shutter-release button halfway to focus (autofocus mode only) and press it all the way down to start or end recording. To end movie live view, press the  button. The shutter-release button on an optional remote cord (□ 298) can be used to start movie live view and to start and end movie recording; the optional ML-L3 remote control, however, can not be used to record movies. In remote control (  mode), pressing the shutter-release button halfway does not start movie live view, while pressing the shutter-release button on the remote control releases the shutter to record a photograph and does not start or end movie recording.

### **Record Movies**

When this option is selected, interval timer (□ 164) is not available and the shutter-release button can not be used during movie live view to record photographs, measure preset white balance, or record image dust off reference data. Select **Take photos** to use these options.

# Y The Setup Menu: *Camera Setup*

To display the setup menu, press **MENU** and select the **Y** (setup menu) tab.

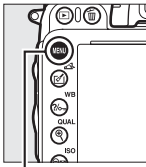

MENU button

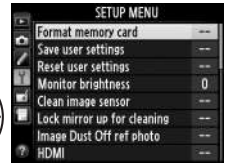

The setup menu contains the following options:

Option		Option	
Format memory card	250	Image comment	253
Save user settings	81	Auto image rotation	254
Reset user settings	82	Battery info	255
Monitor brightness	250	Copyright information	256
Clean image sensor	301	Save/load settings	257
Lock mirror up for cleaning <sup>1</sup>	303	GPS	175
Image Dust Off ref photo	251	Virtual horizon	258
HDMI	205	Non-CPU lens data	172
Flicker reduction	252	AF fine-tune	259
Time zone and date	253	Eye-Fi upload <sup>2</sup>	260
Language	253	Firmware version	260

1 Not available when battery is low.

2 Only displayed when compatible Eye-Fi memory card is inserted (☐ 260).

## See Also

Menu defaults are listed on page 314.



## Format Memory Card

MENU button → Y setup menu

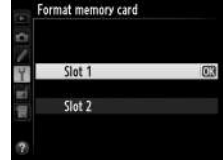

To begin formatting, choose a memory card slot and select **Yes**. Note that formatting permanently deletes all pictures and other data on the card in the selected slot. Before formatting, be sure to make backup copies as required.



### ✓ During Formatting

Do not turn the camera off or remove memory cards during formatting.

### ✍ Two-Button Format

Memory cards can also be formatted by pressing the  (FORMAT) and  (FORMAT) buttons for more than two seconds (☞ 31).

## Monitor Brightness

MENU button → Y setup menu

Adjust the brightness of the monitor for playback, menus, and the information display.

Option	Description
Auto	When the monitor is on, monitor brightness is automatically adjusted according to ambient lighting conditions. Care should be taken not to cover the ambient brightness sensor (☞ 4).
Manual	Press ▲ or ▼ to choose monitor brightness. Choose higher values for increased brightness, lower values for reduced brightness.

### ✍ See Also

For information on adjusting monitor brightness in live view, see page 53.



Acquire reference data for the Image Dust Off option in Capture NX 2 (available separately; for more information, see the Capture NX 2 manual).

**Image Dust Off ref photo** is available only when a CPU lens is mounted on the camera. A non-DX lens with a focal length of at least 50 mm is recommended. When using a zoom lens, zoom all the way in.

## 1 Choose a start option.

Highlight one of the following options and press . To exit without acquiring image dust off data, press MENU.



- **Start:** The message shown at right will be displayed and “rEF” will appear in the viewfinder and control panel displays.
- **Clean sensor and then start:** Select this option to clean the image sensor before starting. The message shown at right will be displayed and “rEF” will appear in the viewfinder and control panel displays when cleaning is complete.

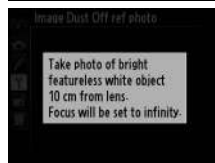

## 2 Frame a featureless white object in the viewfinder.

With the lens about ten centimeters (four inches) from a well-lit, featureless white object, frame the object so that it fills the viewfinder and then press the shutter-release button halfway.

In autofocus mode, focus will automatically be set to infinity; in manual focus mode, set focus to infinity manually.

### 3 Acquire dust off reference data.

Press the shutter-release button the rest of the way down to acquire Image Dust Off reference data. The monitor turns off when the shutter-release button is pressed. Note that noise reduction will be performed if the subject is poorly lit, increasing recording times.

If the reference object is too bright or too dark, the camera may be unable to acquire Image Dust Off reference data and the message shown at right will be displayed. Choose another reference object and repeat the process from step 1.



#### Image Sensor Cleaning

Dust off reference data recorded before image sensor cleaning is performed can not be used with photographs taken after image sensor cleaning is performed. Select **Clean sensor and then start** only if the dust off reference data will not be used with existing photographs.

#### Image Dust Off Reference Data

The same reference data can be used for photographs taken with different lenses or at different apertures. Reference images can not be viewed using computer imaging software. A grid pattern is displayed when reference images are viewed on the camera.



## Flicker Reduction

MENU button →  setup menu

Reduce flicker and banding when shooting under fluorescent or mercury-vapor lighting during live view or movie recording. Choose **Auto** to allow the camera to automatically choose the correct frequency, or manually match the frequency to that of the local AC power supply.

#### Flicker Reduction

If **Auto** fails to produce the desired results and you are unsure as to the frequency of the local power supply, test both the 50 and 60 Hz options and choose the one that produces the best results. Flicker reduction may not produce the desired results if the subject is very bright, in which case you should try choosing a smaller aperture (higher f-number).

## Time Zone and Date

MENU button →  setup menu

Change time zones, set the camera clock, choose the date display order, and turn daylight saving time on or off (□ 27).

Option	Description
<b>Time zone</b>	Choose a time zone. The camera clock is automatically set to the time in the new time zone.
<b>Date and time</b>	Set the camera clock. If the clock is not set, a flashing  icon will appear in the information display.
<b>Date format</b>	Choose the order in which the day, month, and year are displayed.
<b>Daylight saving time</b>	Turn daylight saving time on or off. The camera clock will automatically be advanced or set back one hour. The default setting is <b>Off</b> .

## Language

MENU button →  setup menu

Choose a language for camera menus and messages.

## Image Comment

MENU button →  setup menu

Add a comment to new photographs as they are taken. Comments can be viewed as metadata in ViewNX 2 (supplied) or Capture NX 2 (available separately; □ 298). The comment is also visible on the shooting data page in the photo information display (□ 182).

- **Done:** Save changes and return to the setup menu.
- **Input comment:** Input a comment as described on page 135. Comments can be up to 36 characters long.
- **Attach comment:** Select this option to attach the comment to all subsequent photographs. **Attach comment** can be turned on and off by highlighting it and pressing .



## Auto Image Rotation

MENU button → Y setup menu

Photographs taken while **On** is selected contain information on camera orientation, allowing them to be rotated automatically during playback (📖 177) or when viewed in ViewNX 2 (supplied) or in Capture NX 2 (available separately; 📖 298). The following orientations are recorded:



*Landscape (wide orientation)*



*Camera rotated 90° clockwise*



*Camera rotated 90° counter-clockwise*

Camera orientation is not recorded when **Off** is selected. Choose this option when panning or taking photographs with the lens pointing up or down.

### Rotate Tall

To automatically rotate “tall” (portrait-orientation) photographs for display during playback, select **On** for the **Rotate tall** option in the playback menu (📖 212).

## Battery Info

MENU button →  setup menu

View information on the battery currently inserted in the camera.

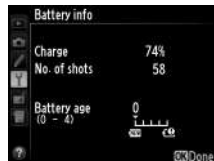

Item	Description
<b>Charge</b>	The current battery level expressed as a percentage.
<b>No. of shots</b>	The number of times the shutter has been released with the current battery since the battery was last charged. Note that the camera may sometimes release the shutter without recording a photograph, for example when measuring preset white balance.
<b>Battery age</b>	A five-level display showing battery age. 0 ( <b>NEW</b> ) indicates that battery performance is unimpaired, 4 ( <b>OLD</b> ) that the battery has reached the end of its charging life and should be replaced. Note that batteries charged at temperatures under about 5 °C (41 °F) may show a temporary drop in charging life; the battery age display will however return to normal once the battery has been recharged at a temperature of about 20 °C (68 °F) or higher.

### The MB-D14 Battery Pack

The display for the MB-D14 battery pack is shown at right. If AA batteries are used, the battery level will be shown by a battery level icon; other items will not be displayed.

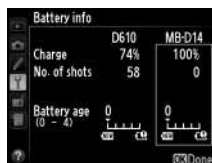

Add copyright information to new photographs as they are taken. Copyright information is included in the shooting data shown in the photo information display (□ 182) and can be viewed as metadata in ViewNX 2 (supplied) or in Capture NX 2 (available separately; □ 298).

- **Done:** Save changes and return to the setup menu.
- **Artist:** Enter a photographer name as described on page 135. Photographer names can be up to 36 characters long.
- **Copyright:** Enter the name of the copyright holder as described on page 135. Copyright holder names can be up to 54 characters long.
- **Attach copyright information:** Select this option to attach copyright information to all subsequent photographs. **Attach copyright information** can be turned on and off by highlighting it and pressing ►.



### Copyright Information

To prevent unauthorized use of the artist or copyright holder names, make sure that **Attach copyright information** is not selected and that the **Artist** and **Copyright** fields are blank before lending or transferring the camera to another person. Nikon does not accept liability for any damages or disputes arising from the use of the **Copyright information** option.

## Save/Load Settings

MENU button →  setup menu

Select **Save settings** to save the following settings to the memory card in Slot 1 (☐ 96; if the card is full, an error will be displayed). Use this option to share settings among D610 cameras.

Menu	Option	Menu	Option	
Playback	Playback display options	Custom settings	All Custom Settings except <b>Reset custom settings</b>	
	Image review		Clean image sensor	
	After delete		HDMI	
	Rotate tall		Flicker reduction	
Shooting	File naming	Setup	Time zone and date (excepting date and time)	
	Role played by card in Slot 2		Language	
	Image quality		Image comment	
	Image size		Auto image rotation	
	Image area		Copyright information	
	JPEG compression		GPS	
	NEF (RAW) recording		Non-CPU lens data	
	White balance (with fine-tuning and presets d-1–d-4)		Eye-Fi upload	
	Set Picture Control		My Menu/ Recent Settings	All My Menu items
	Auto distortion control			All recent settings
	Color space	Choose tab		
	Active D-Lighting			
	Vignette control			
	Long exposure NR			
	High ISO NR			
	ISO sensitivity settings			
	Remote control mode			
Movie settings				

Settings saved using this model of camera can be restored by selecting **Load settings**. Note that **Save/load settings** is only available when a memory card is inserted in the camera, and that the **Load settings** option is only available if the card contains saved settings.

### Saved Settings

Settings are saved in a file named NCSETUPC. The camera will not be able to load settings if the file name is changed.



Display roll and pitch information based on information from the camera tilt sensor. If the camera is tilted neither left nor right, the roll reference line will turn green, while if the camera is tilted neither forward nor back, the pitch reference line will turn green and a dot will appear in the center of the display. Each division is equivalent to 5°.

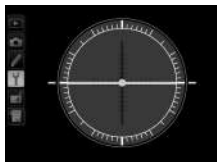

*Camera level*



*Camera tilted left or  
right*

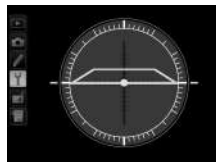

*Camera tilted forward  
or back*

### **Tilting the Camera**



The virtual horizon display is not accurate when the camera is tilted at a sharp angle forward or back. If the camera is unable to measure tilt, the amount of tilt will not be displayed.

### **See Also**

For information on viewing a roll indicator in the viewfinder, see Custom Setting f2 (**Assign Fn button**;  242, 243). For information on displaying a virtual horizon in live view, see pages 55 and 62.



Fine-tune focus for up to 12 lens types. AF tuning is not recommended in most situations and may interfere with normal focus; use only when required.

Option	Description
<b>AF fine-tune (On/Off)</b>	<ul style="list-style-type: none"> <li>• <b>On:</b> Turn AF tuning on.</li> <li>• <b>Off:</b> Turn AF tuning off.</li> </ul>
<b>Saved value</b>	<p>Tune AF for the current lens (CPU lenses only). Press ▲ or ▼ to choose a value between +20 and -20. Values for up to 12 lens types can be stored. Only one value can be stored for each type of lens.</p>
<b>Default</b>	<p>Choose the AF tuning value used when no previously saved value exists for the current lens (CPU lenses only).</p>
<b>List saved values</b>	<p>List previously saved AF tuning values. To delete a lens from the list, highlight the desired lens and press  (DELETE). To change a lens identifier (for example, to choose an identifier that is the same as the last two digits of the lens serial number to distinguish it from other lenses of the same type in light of the fact that <b>Saved value</b> can be used with only one lens of each type), highlight the desired lens and press ►.</p> <p>The menu shown at right will be displayed; press ▲ or ▼ to choose an identifier and press  to save changes and exit.</p>

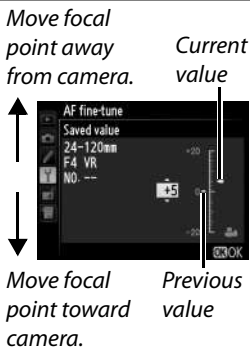

## AF Tuning

The camera may be unable to focus at minimum range or at infinity when AF tuning is applied.

## Live View

Tuning is not applied to autofocus during in live view ( 53).

## Saved Value

Only one value can be stored for each type of lens. If a teleconverter is used, separate values can be stored for each combination of lens and teleconverter.









## Eye-Fi Upload

MENU button → Y setup menu

This option is displayed only when an Eye-Fi memory card (available separately from third-party suppliers) is inserted in the camera. Choose **Enable** to upload photographs to a preselected destination. Note that pictures will not be uploaded if signal strength is insufficient.

Observe all local laws concerning wireless devices and choose **Disable** where wireless devices are prohibited.

When an Eye-Fi card is inserted, its status is indicated by an icon in the information display:

- : Eye-Fi upload disabled.
- : Eye-Fi upload enabled but no pictures available for upload.
-  (static): Eye-Fi upload enabled; waiting to begin upload.
-  (animated): Eye-Fi upload enabled; uploading data.
- : Error — camera can not control Eye-Fi card. If a flashing  appears in the control panel or viewfinder, refer to page 324; if this indicator is not flashing, pictures can be taken normally but you may be unable to change Eye-Fi settings.



### Eye-Fi Cards

Eye-Fi cards may emit wireless signals when **Disable** is selected. If a warning is displayed in the monitor ( 324), turn the camera off and remove the card.

See the manual provided with the Eye-Fi card, and direct any inquiries to the manufacturer. The camera can be used to turn Eye-Fi cards on and off, but may not support other Eye-Fi functions.

Some cards may not be available in some countries or regions; consult the manufacturer for more information. Eye-Fi cards are for use only in the country of purchase. Be sure the Eye-Fi card firmware has been updated to the latest version.

### Using Eye-Fi Cards in Ad Hoc Mode

Additional time may be required when connecting using Eye-Fi cards that support ad hoc mode. Set Custom Setting c2 (**Standby timer**,  227) to 30 s or longer.

## Firmware Version

MENU button → Y setup menu

View the current camera firmware version.





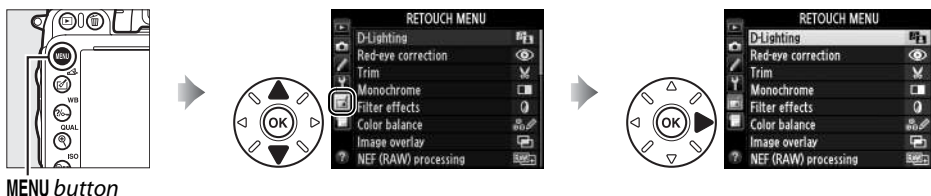

















# The Retouch Menu: Creating Retouched Copies





To display the retouch menu, press **MENU** and select the  (retouch menu) tab.



MENU button

The options in the retouch menu are used to create trimmed or retouched copies of existing pictures. The retouch menu is only displayed when a memory card containing photographs is inserted in the camera (note that if the memory card is being used to store both RAW/NEF and JPEG copies of the same photographs as described on page 93, retouch other than **Image overlay** and **NEF (RAW) processing** apply only to the JPEG copies).

Option		Option	
 <b>D-Lighting</b>	264	 <b>Straighten</b>	274
 <b>Red-eye correction</b>	264	 <b>Distortion control</b>	274
 <b>Trim</b>	265	 <b>Fisheye</b>	274
 <b>Monochrome</b>	266	 <b>Color outline</b>	275
 <b>Filter effects</b>	267	 <b>Color sketch</b>	275
 <b>Color balance</b>	268	 <b>Perspective control</b>	275
 <b>Image overlay</b> <sup>1</sup>	269	 <b>Miniature effect</b>	276
 <b>NEF (RAW) processing</b>	271	 <b>Selective color</b>	277
 <b>Resize</b>	272	 <b>Edit movie</b>	69
 <b>Quick retouch</b>	273	 <b>Side-by-side comparison</b> <sup>2</sup>	279

- 1 Can only be selected by pressing **MENU** and selecting  tab.
- 2 Only available if  or  () is pressed in full-frame playback when a retouched image or original is displayed.

## Retouching Copies

Most options can be applied to copies created using other retouch options, although with the exceptions of **Image overlay** and **Edit movie > Choose start/end point** each option can be applied only once (note that multiple edits may result in loss of detail). Options that can not be applied to the current image are grayed out and unavailable.

## Image Quality

Except in the case of copies created with **Trim**, **Image overlay**, **NEF (RAW) processing**, and **Resize**, copies created from JPEG images are the same size and quality as the original, while copies created from NEF (RAW) photos are saved as large fine-quality JPEG images. Size-priority compression is used when copies are saved in JPEG format.

# Creating Retouched Copies

To create a retouched copy:

## 1 Select an item in the retouch menu.

Press ▲ or ▼ to highlight an item, ► to select.

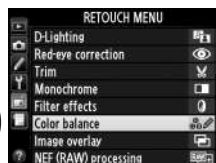

## 2 Select a picture.

Highlight a picture and press OK (to view the highlighted picture full screen, press and hold the Q (QUAL) button; to view images in other locations as described on page 178, hold BKT and press ▲).



### Retouch

The camera may not be able to display or retouch images created with other devices.

## 3 Select retouch options.

For more information, see the section for the selected item. To exit without creating a retouched copy, press MENU.

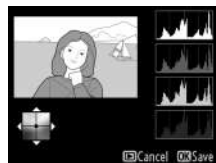

### Monitor off Delay

The monitor will turn off and the operation will be cancelled if no actions are performed for a brief period. Any unsaved changes will be lost. To increase the time the monitor remains on, choose a longer menu display time for Custom Setting c4 (Monitor off delay; 228).

## 4 Create a retouched copy.



Press OK to create a retouched copy. Retouched copies are indicated by a  icon.



## **Creating Retouched Copies During Playback**

Retouched copies can also be created during playback.



Display picture full frame and press  or .



Highlight an option and press .

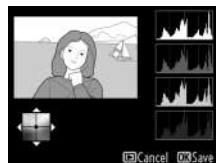

Create retouched copy.

## D-Lighting

MENU button →  retouch menu

D-lighting brightens shadows, making it ideal for dark or backlit photographs.



Before



After



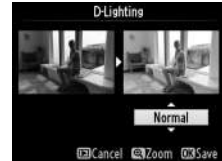





Press ▲ or ▼ to choose the amount of correction performed. The effect can be previewed in the edit display. Press ⓧ to copy the photograph.



## Red-Eye Correction

MENU button →  retouch menu

This option is used to correct “red-eye” caused by the flash, and is available only with photographs taken using the flash. The photograph selected for red-eye correction can be previewed in the edit display. Confirm the effects of red-eye correction and create a copy as described in the following table. Note that red-eye correction may not always produce the expected results and may in very rare circumstances be applied to portions of the image that are not affected by red-eye; check the preview thoroughly before proceeding.







To	Use	Description	
Zoom in	 (QUAL)	Press  (QUAL) to zoom in,  (ISO) to zoom out. While photo is zoomed in, use multi selector to view areas of image not visible in monitor. Keep multi selector pressed to scroll rapidly to other areas of frame. Navigation window is displayed when zoom buttons or multi selector is pressed; area currently visible in monitor is indicated by yellow border. Press  to cancel zoom.	
Zoom out	 (ISO)		
View other areas of image			
Cancel zoom			
Create copy		If the camera detects red-eye in the selected photograph, a copy will be created that has been processed to reduce its effects. No copy will be created if the camera is unable to detect red-eye.	

## Trim

MENU button →  retouch menu

Create a cropped copy of the selected photograph. The selected photograph is displayed with the selected crop shown in yellow; create a cropped copy as described in the following table.



To	Use	Description
Reduce size of crop	 (ISO)	Press  (ISO) to reduce the size of the crop.
Increase size of crop	 (QUAL)	Press  (QUAL) to increase the size of the crop.
Change crop aspect ratio		Rotate the main command dial to switch between aspect ratios of 3 : 2, 4 : 3, 5 : 4, 1 : 1, and 16 : 9.
Position crop		Use multi selector to position the crop. Press and hold to move the crop rapidly to the desired position.
Create copy		Save the current crop as a separate file.

### Trim: Image Quality and Size

Copies created from NEF (RAW) or NEF (RAW) + JPEG photos have an image quality (93) of JPEG fine; cropped copies created from JPEG photos have the same image quality as the original. The size of the copy varies with crop size and aspect ratio and appears at upper left in the crop display.



### Viewing Cropped Copies

Playback zoom may not be available when cropped copies are displayed.



## Monochrome

MENU button →  retouch menu

Copy photographs in **Black-and-white**, **Sepia**, or **Cyanotype** (blue and white monochrome).

Selecting **Sepia** or **Cyanotype** displays a preview of the selected image; press ▲ to increase color saturation, ▼ to decrease. Press OK to create a monochrome copy.

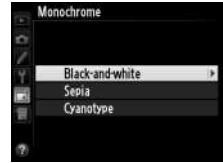

Increase  
saturation



Decrease  
saturation













## Filter Effects

MENU button →  retouch menu

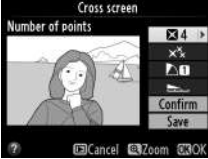
Choose from the following filter effects. After adjusting filter effects as described below, press  to copy the photograph.

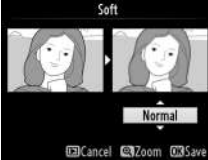
Option	Description	
<b>Skylight</b>	Creates the effect of a skylight filter, making the picture less blue. The effect can be previewed in the monitor as shown at right.	
<b>Warm filter</b>	Creates a copy with warm tone filter effects, giving the copy a “warm” red cast. The effect can be previewed in the monitor.	
<b>Red intensifier</b>	Intensify reds ( <b>Red intensifier</b> ), greens ( <b>Green intensifier</b> ), or blues ( <b>Blue intensifier</b> ). Press  to increase the effect,  to decrease.	
<b>Green intensifier</b>		
<b>Blue intensifier</b>		
<b>Cross screen</b>	<p>Add starburst effects to light sources.</p> <ul style="list-style-type: none"> <li>• <b>Number of points:</b> Choose from four, six, or eight.</li> <li>• <b>Filter amount:</b> Choose the brightness of the light sources affected.</li> <li>• <b>Filter angle:</b> Choose the angle of the points.</li> <li>• <b>Length of points:</b> Choose the length of points.</li> <li>• <b>Confirm:</b> Preview the effects of the filter as shown at right. Press  to preview the copy full frame.</li> <li>• <b>Save:</b> Create a retouched copy.</li> </ul>	
<b>Soft</b>	Add a soft filter effect. Press  or  to choose the filter strength.	



# Color Balance

MENU button →  retouch menu

Use the multi selector to create a copy with modified color balance as shown below. The effect is displayed in the monitor together with red, green, and blue histograms (☐ 181) giving the distribution of tones in the copy.

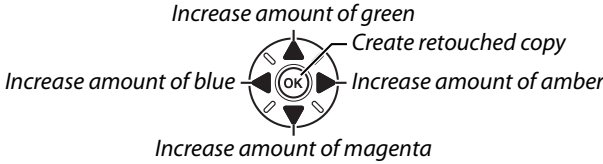
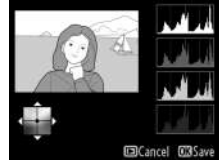

## Zoom

To zoom in on the image displayed in the monitor, press **Q** (**QUAL**). The histogram will be updated to show data only for the portion of the image displayed in the monitor. While the image is zoomed in, press **W** (**WB**) to toggle back and forth between color balance and zoom. When zoom is selected, you can zoom in and out with the **Q** (**QUAL**) and **I** (**ISO**) and scroll the image with the multi selector.

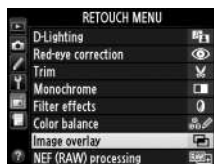

Image overlay combines two existing NEF (RAW) photographs to create a single picture that is saved separately from the originals; the results, which make use of RAW data from the camera image sensor, are noticeably better than overlays created in an imaging application. The new picture is saved at current image quality and size settings; before creating an overlay, set image quality and size (☐ 93, 95; all options are available). To create a NEF (RAW) copy, choose an image quality of **NEF (RAW)**.



## 1 Select Image overlay.

Highlight **Image overlay** in the retouch menu and press ►.



The dialog shown at right will be displayed, with **Image 1** highlighted; press **OK** to display a list of the NEF pictures created with this camera.



## 2 Select the first image.

Use the multi selector to highlight the first photograph in the overlay. To view the highlighted photograph full frame, press and hold the **QUAL** button (to view images in other locations as described on page 178, hold **BKT** and press ▲). Press **OK** to select the highlighted photograph and return to the preview display.



## 3 Select the second image.

The selected image will appear as **Image 1**. Highlight **Image 2** and press **OK**, then select the second photo as described in Step 2.



## 4 Adjust gain.

Highlight **Image 1** or **Image 2** and optimize exposure for the overlay by pressing ▲ or ▼ to select gain from values between 0.1 and 2.0. Repeat for the second image. The default value is 1.0; select 0.5 to halve gain or 2.0 to double it. The effects are visible in the **Preview** column.

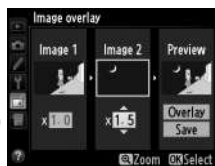

## 5 Preview the overlay.

Press ◀ or ▶ to place the cursor in the **Preview** column and press ▲ or ▼ to highlight **Overlay**. Press Ⓚ to preview the overlay as shown at right (to save the overlay without displaying a preview, select **Save**). To return to Step 4 and select new photos or adjust gain, press  $\text{ISO}$ .



## 6 Save the overlay.

Press Ⓚ while the preview is displayed to save the overlay. After an overlay is created, the resulting image will be displayed full-frame in the monitor.



### Image Overlay

Only NEF (RAW) photographs with the same image area and bit depth can be combined.

The overlay has the same photo info (including date of recording, metering, shutter speed, aperture, shooting mode, exposure compensation, focal length, and image orientation), and values for white balance and Picture Control as the photograph selected for **Image 1**. The current image comment is appended to the overlay when it is saved; copyright information, however, is not copied. Overlays saved in NEF (RAW) format use the compression selected for **Type** in the **NEF (RAW) recording** menu and have the same bit depth as the original images; JPEG overlays are saved using size-priority compression.

Create JPEG copies of NEF (RAW) photographs.

## 1 Select NEF (RAW) processing.

Highlight **NEF (RAW) processing** in the retouch menu and press to display a picture selection dialog listing only NEF (RAW) images created with this camera.

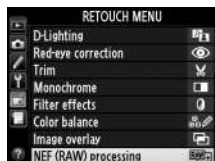

## 2 Select a photograph.

Highlight a photograph (to view the highlighted photograph full frame, press and hold the (**QUAL**) button; to view images in other locations as described on page 178, hold **BKT** and press ). Press to select the highlighted photograph and proceed to the next step.



## 3 Choose settings for the JPEG copy.

Adjust the settings listed below. Note that white balance and vignette control are not available with multiple exposures or pictures created with image overlay and that exposure compensation can only be set to values between  $-2$  and  $+2$  EV. The Picture Control grid is not displayed when Picture Controls are adjusted.

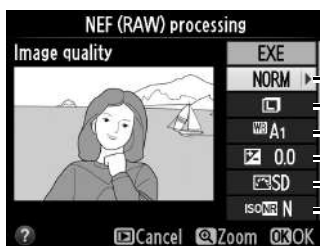

- Image quality (□ 93)
- Image size (□ 95)
- White balance (□ 115)
- Exposure compensation (□ 112)
- Set Picture Control (□ 129)
- High ISO NR (□ 218)

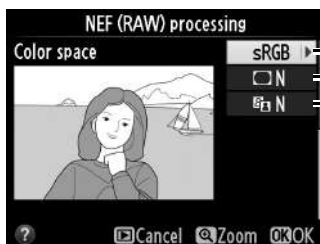

- Color space (□ 217)
- Vignette control (□ 218)
- D-Lighting (□ 264)



## 4 Copy the photograph.

Highlight **EXE** and press **OK** to create a JPEG copy of the selected photograph (to exit without copying the photograph, press the **MENU** button).



## Resize

**MENU button** →  **retouch menu**

Create small copies of selected photographs.

### 1 Select **Resize**.

To resize selected images, press **MENU** to display the menus and select **Resize** in the retouch menu.



### 2 Choose a destination.

If two memory cards are inserted, you can choose a destination for the resized copies by highlighting **Choose destination** and pressing **▶** (if only one card is inserted, proceed to Step 3).

The menu shown at right will be displayed; highlight a card slot and press **OK**.

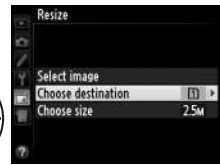

### 3 Choose a size.

Highlight **Choose size** and press **▶**.

The options shown at right will be displayed; highlight an option and press **OK**.



## 4 Choose pictures.

Highlight **Select image** and press ►.



The dialog shown at right will be displayed; highlight pictures using the multi selector and press the **ISO** button to select or deselect (to view the highlighted picture full screen, press and hold the **QUAL** button; to view images in other locations as described on page 178, hold **BKT** and press ▲). Selected pictures are marked by a  icon. Press **OK** when the selection is complete.



## 5 Save the resized copies.

A confirmation dialog will be displayed. Highlight **Yes** and press **OK** to save the resized copies.



### Viewing Resized Copies

Playback zoom may not be available when resized copies are displayed.

### Image Quality

Copies created from NEF (RAW) or NEF (RAW) + JPEG photos have an image quality (93) of JPEG fine; copies created from JPEG photos have the same image quality as the original.

## Quick Retouch

MENU button →  retouch menu

Create copies with enhanced saturation and contrast. D-Lighting is applied as required to brighten dark or backlit subjects.

Press ▲ or ▼ to choose the amount of enhancement. The effect can be previewed in the edit display. Press **OK** to copy the photograph.

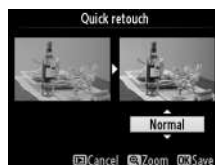

## Straighten

MENU button →  retouch menu

Create a straightened copy of the selected image. Press ► to rotate the image clockwise by up to five degrees in increments of approximately 0.25 degrees, ◀ to rotate it counterclockwise (the effect can be previewed in the edit display; note that edges of the image will be trimmed to create a square copy). Press Ⓚ to copy the photograph, or press ► to exit to playback without creating a copy.

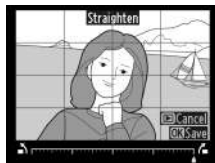

## Distortion Control

MENU button →  retouch menu

Create copies with reduced peripheral distortion. Select **Auto** to let the camera correct distortion automatically and then make fine adjustments using the multi selector, or select **Manual** to reduce distortion manually (note that **Auto** is not available with photos taken using auto distortion control; see page 217). Press ► to reduce barrel distortion, ◀ to reduce pin-cushion distortion (the effect can be previewed in the edit display; note that greater amounts of distortion control result in more of the edges being cropped out). Press Ⓚ to copy the photograph, or press ► to exit to playback without creating a copy. Note that distortion control may heavily crop or distort the edges of copies created from photographs taken with DX lenses at an image area setting of **FX (36×24) 1.0x**.



### Auto

**Auto** is for use only with pictures taken with type G, E, and D lenses (PC, fisheye, and certain other lenses excluded). Results are not guaranteed with other lenses.

## Fisheye

MENU button →  retouch menu

Create copies that appear to have been taken with a fisheye lens. Press ► to increase the effect (this also increases the amount of that will be cropped out at the edges of the image), ◀ to reduce it. The effect can be previewed in the edit display. Press Ⓚ to copy the photograph, or press ► to exit to playback without creating a copy.





## Color Outline

MENU button →  retouch menu

Create an outline copy of a photograph to use as a base for painting. The effect can be previewed in the edit display. Press  to copy the photograph.



Before

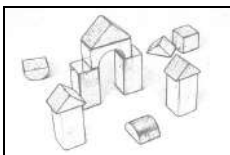







After



## Color Sketch



MENU button →  retouch menu

Create a copy of a photograph that resembles a sketch made with colored pencils. Press  or  to highlight **Vividness** or **Outlines** and press  or  to change. Vividness can be increased to make colors more saturated, or decreased for a washed-out, monochromatic effect, while outlines can be made thicker or thinner. Thicker outlines makes colors more saturated. The results can be previewed in the edit display. Press  to copy the photograph, or press  to exit to playback without creating a copy.



## Perspective Control

MENU button →  retouch menu

Create copies that reduce the effects of perspective taken from the base of a tall object. Use the multi selector to adjust perspective (note that greater amounts of perspective control result in more of the edges being cropped out). The results can be previewed in the edit display. Press  to copy the photograph, or press  to exit to playback without creating a copy.



Before











After



# Miniature Effect

MENU button →  retouch menu

Create a copy that appears to be a photo of a diorama. Works best with photos taken from a high vantage point. The area that will be in focus in the copy is indicated by a yellow frame.

To	Press	Description
Choose orientation	 (ISO)	Press  (ISO) to choose orientation of area that is in focus.
Choose position		If area of effect is in wide orientation, press ▲ or ▼ to position frame showing area of copy that will be in focus.
		If area of effect is in tall orientation, press ◀ or ▶ to position frame showing area of copy that will be in focus.
Choose size		If area of effect is in wide orientation, press ◀ or ▶ to choose height.
		If area of effect is in tall orientation, press ▲ or ▼ to choose width.
Preview copy	 (QUAL)	Preview copy.
Cancel		Exit to full-frame playback without creating copy.
Create copy		Create copy.

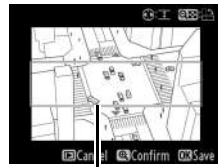

Area in focus

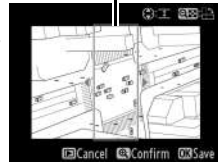

Create a copy in which only selected hues appear in color.

## 1 Select Selective color.

Highlight **Selective color** in the retouch menu and press **▶** to display a picture selection dialog.



## 2 Select a photograph.

Highlight a photograph (to view the highlighted photograph full frame, press and hold the **QUAL** button; to view images in other locations as described on page 178, hold **BKT** and press **▲**). Press **OK** to select the highlighted photograph and proceed to the next step.



## 3 Select a color.

Use the multi selector to position the cursor over an object and press the **AE-L/AF-L** button to select the color of the object as one that will remain in the final copy (the camera may have difficulty detecting unsaturated colors; choose a saturated color). To zoom in on the picture for precise color selection, press **QUAL**. Press **ISO** to zoom out.

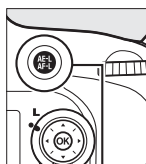

AE-L/AF-L button

Selected color



## 4 Highlight the color range.

Rotate the main command dial to highlight the color range for the selected color.



Color range



---



## 5 Choose the color range.

Press ▲ or ▼ to increase or decrease the range of similar hues that will be included in the final photograph or movie. Choose from values between 1 and 7; note that higher values may include hues from other colors. The effect can be previewed in the edit display.



---

## 6 Select additional colors.

To select additional colors, rotate the main command dial to highlight another of the three color boxes at the top of the display and repeat Steps 3–5 to select another color. Repeat for a third color if desired. To deselect the highlighted color, press  (FORMAT), or press and hold  (FORMAT) to remove all colors.



---

## 7 Save the edited copy.

Press  to copy the photograph.



## Side-by-side Comparison

Compare retouched copies to the original photographs. This option is only available if **OK** or **OK** (**OK**) button is pressed to display the retouch menu when a copy or original is played back full frame.

### 1 Select a picture.

In full-frame playback, select a retouched copy (shown by a **OK** icon) or a photograph that has been retouched and press **OK** or **OK** (**OK**).



### 2 Select Side-by-side comparison.

Highlight **Side-by-side comparison** and press **OK**.



### 3 Compare the copy with the original.

The source image is displayed on the left, the retouched copy on the right, with the options used to create the copy listed at the top of the display. Press **◀** or **▶** to switch between the source image and the retouched copy. To view the highlighted picture full frame, press and hold the **QUAL** button. If the copy was created from two source images using **Image overlay**, or if the source has been copied multiple times, press **▲** or **▼** to view the other source images or copies. To exit to playback mode, press the **▶** button, or press **OK** to exit to playback with the highlighted image selected.

*Options used to create copy*

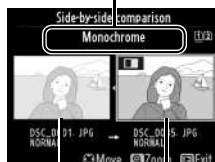

*Source image      Retouched copy*

#### **✔ Side-by-side Comparisons**

The source image will not be displayed if the copy was created from a photograph that was protected (188), is on a locked memory card, has since been deleted or hidden (208), or is on a card in a different slot from that used when the image was created.



# ☑ My Menu / ☰ Recent Settings

To display My Menu, press **MENU** and select the ☑ (My Menu) tab.

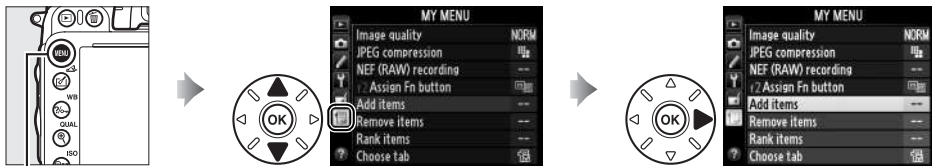

MENU button

The **My Menu** option can be used to create and edit a customized list of options from the playback, shooting, Custom Settings, setup, and retouch menus for quick access (up to 20 items). If desired, recent settings can be displayed in place of My Menu (☑ 283).

Options can be added, deleted, and reordered as described below.

## ■ Adding Options to My Menu

### 1 Select Add items.

In My Menu (☑), highlight **Add items** and press ►.

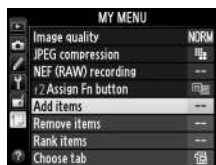

### 2 Select a menu.

Highlight the name of the menu containing the option you wish to add and press ►.

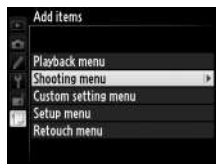

### 3 Select an item.

Highlight the desired menu item and press **OK**.

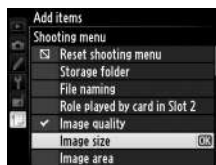

### 4 Position the new item.

Press ▲ or ▼ to move the new item up or down in My Menu. Press **OK** to add the new item.



## 5 Add more items.

The items currently displayed in My Menu are indicated by a check mark. Items indicated by a  icon can not be selected. Repeat steps 1–4 to select additional items.

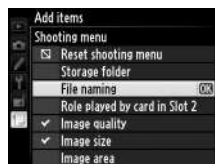

## ■ Deleting Options from My Menu

### 1 Select Remove items.

In My Menu () , highlight **Remove items** and press  .

### 2 Select items.

Highlight items and press  to select or deselect. Selected items are indicated by a check mark.

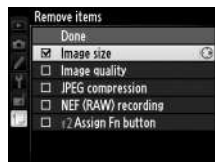

### 3 Select Done.

Highlight **Done** and press  . A confirmation dialog will be displayed.

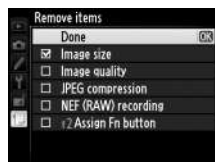

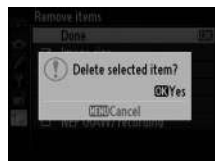

### 4 Delete the selected items.

Press  to delete the selected items.



### Deleting Items in My Menu

To delete the item currently highlighted in My Menu, press the  button. A confirmation dialog will be displayed; press  again to remove the selected item from My Menu.



## ■ ■ Reordering Options in My Menu

### 1 Select Rank items.

In My Menu (☰), highlight **Rank items** and press ►.

### 2 Select an item.

Highlight the item you wish to move and press **OK**.



### 3 Position the item.

Press ▲ or ▼ to move the item up or down in My Menu and press **OK**. Repeat Steps 2–3 to reposition additional items.



### 4 Exit to My Menu.

Press the **MENU** button to return to My Menu.

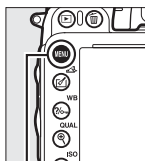

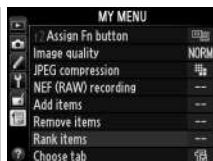

MENU button







# Recent Settings



To display the twenty most recently used settings, select  **Recent settings** for  **My Menu > Choose tab.**

## 1 Select Choose tab.



In My Menu () , highlight **Choose tab** and press .



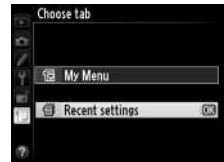

## 2 Select Recent settings.

Highlight  **Recent settings** and press  .  
The name of the menu will change from “MY MENU” to “RECENT SETTINGS.”



Menu items will be added to the top of the recent settings menu as they are used. To view My Menu again, select  **My Menu** for  **Recent settings > Choose tab.**

### Removing Items from the Recent Settings Menu

To remove an item from the recent settings menu, highlight it and press the  (**FORMAT**) button. A confirmation dialog will be displayed; press  (**FORMAT**) again to delete the selected item.







# Technical Notes

Read this chapter for information on compatible accessories, cleaning and storing the camera, and what to do if an error message is displayed or you encounter problems using the camera.

## Compatible Lenses

Lens/accessory		Camera setting	Focus mode			Shooting mode		Metering system		
		AF	M (with electronic rangefinder)	M	P S	A M	☑		☑	
							3D	Color	☐	
CPU lenses <sup>1</sup>	Type G, E, or D AF NIKKOR <sup>2</sup> AF-S, AF-I NIKKOR	✓	✓	✓	✓	✓	✓	—	✓ <sup>3</sup>	
	PC-E NIKKOR series	—	✓ <sup>5</sup>	✓	✓ <sup>5</sup>	✓ <sup>5</sup>	✓ <sup>5</sup>	—	✓ <sup>3,5</sup>	
	PC Micro 85mm f/2.8D <sup>4</sup>	—	✓ <sup>5</sup>	✓	—	✓ <sup>6</sup>	✓	—	✓ <sup>3,5</sup>	
	AF-S / AF-I Teleconverter <sup>7</sup>	✓	✓	✓	✓	✓	✓	—	✓ <sup>3</sup>	
	Other AF NIKKOR (except lenses for F3AF)	✓ <sup>8</sup>	✓ <sup>8</sup>	✓	✓	✓	—	✓	✓ <sup>3</sup>	
	AI-P NIKKOR	—	✓ <sup>9</sup>	✓	✓	✓	—	✓	✓ <sup>3</sup>	
Non-CPU lenses <sup>10</sup>	AI-, AI-modified, NIKKOR or Nikon Series E lenses <sup>11</sup>	—	✓ <sup>9</sup>	✓	—	✓ <sup>12</sup>	—	✓ <sup>13</sup>	✓ <sup>14</sup>	
	Medical-NIKKOR 120mm f/4	—	✓	✓	—	✓ <sup>15</sup>	—	—	—	
	Reflex-NIKKOR	—	—	✓	—	✓ <sup>12</sup>	—	—	✓ <sup>14</sup>	
	PC-NIKKOR	—	✓ <sup>5</sup>	✓	—	✓ <sup>16</sup>	—	—	✓	
	AI-type Teleconverter <sup>17</sup>	—	✓ <sup>18</sup>	✓	—	✓ <sup>12</sup>	—	✓ <sup>13</sup>	✓ <sup>14</sup>	
	PB-6 Bellows Focusing Attachment <sup>19</sup>	—	✓ <sup>18</sup>	✓	—	✓ <sup>20</sup>	—	—	✓	
Auto extension rings (PK-series 11A, 12, or 13; PN-11)	—	✓ <sup>18</sup>	✓	—	✓ <sup>12</sup>	—	—	✓		

1 IX-NIKKOR lenses can not be used.

2 Vibration Reduction (VR) supported with VR lenses.

3 Spot metering meters selected focus point (☐ 109).

4 The camera's exposure metering and flash control systems do not work properly when shifting and/or tilting the lens, or when an aperture other than the maximum aperture is used.

5 Can not be used with shifting or tilting.

6 Manual shooting mode only.

7 Can be used with AF-S and AF-I lenses only (☐ 287). For information on the focus points available for autofocus and electronic rangefinding, see page 287.

8 When focusing at minimum focus distance with AF 80–200mm f/2.8, AF 35–70mm f/2.8, AF 28–85mm f/3.5–4.5 <New>, or AF 28–85mm f/3.5–4.5 lens at maximum zoom, in-focus indicator may be displayed when image on matte screen in viewfinder is not in focus. Adjust focus manually until image in viewfinder is in focus.

9 With maximum aperture of f/5.6 or faster.

10 Some lenses can not be used (see page 288).



- 11 Range of rotation for AI 80–200mm f/2.8 ED tripod mount is limited by camera body. Filters can not be exchanged while AI 200–400mm f/4 ED is mounted on camera.
- 12 If maximum aperture is specified using **Non-CPU lens data** (□ 172), aperture value will be displayed in viewfinder and control panel.
- 13 Can be used only if lens focal length and maximum aperture are specified using **Non-CPU lens data** (□ 172). Use spot or center-weighted metering if desired results are not achieved.
- 14 For improved precision, specify lens focal length and maximum aperture using **Non-CPU lens data** (□ 172).
- 15 Can be used in manual mode **M** at shutter speeds slower than flash sync speed by one step or more.
- 16 Exposure determined by presetting lens aperture. In mode **A**, preset aperture using lens aperture ring before performing AE lock and shifting lens. In mode **M**, preset aperture using lens aperture ring and determine exposure before shifting lens.
- 17 Exposure compensation required when used with AI 28–85mm f/3.5–4.5, AI 35–105mm f/3.5–4.5, AI 35–135mm f/3.5–4.5, or AF-S 80–200mm f/2.8D. See teleconverter manual for details.
- 18 With maximum effective aperture of f/5.6 or faster.
- 19 Requires PK-12 or PK-13 auto extension ring. PB-6D may be required depending on camera orientation.
- 20 Use preset aperture. In mode **A**, set aperture using focusing attachment before determining exposure and taking photograph.
  - PF-4 Reprocopy Outfit requires PA-4 Camera Holder.
  - Noise in the form of lines may appear during autofocus at high ISO sensitivities. Use manual focus or focus lock.



## Recognizing CPU and Type G, E, and D Lenses

CPU lenses (particularly types G, E, and D) are recommended, but note that IX-NIKKOR lenses can not be used. CPU lenses can be identified by the presence of CPU contacts, type G, E, and D lenses by a letter on the lens barrel. Type G and E lenses are not equipped with a lens aperture ring.

CPU contacts

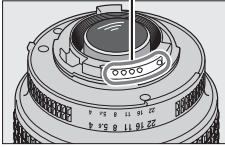

CPU lens

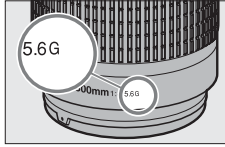

Type G/E lens

Aperture ring

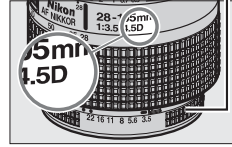

Type D lens

## AF-S/AF-I Teleconverters

The table below shows the focus points available for autofocus and electronic rangefinding when an AF-S/AF-I teleconverter is attached. Note that the camera may be unable to focus on dark or low-contrast subjects if the combined aperture is slower than f/5.6. Autofocus is not available when teleconverters are used with the AF-S VR Micro-Nikkor 105mm f/2.8G IF-ED.

Accessory	Maximum aperture of lens	Focus points	Accessory	Maximum aperture of lens	Focus points
TC-14E, TC-14E II	f/4 or faster	<pre> ○○○○○○○○ ○○○○○○○○ ○○○○○○○○ ○○○○○○○○                     </pre>	TC-20E, TC-20E II, TC-20E III	f/2.8 or faster	<pre> ○○○○○○○○ ○○○○○○○○ ○○○○○○○○ ○○○○○○○○                     </pre>
	f/5.6	<pre> ○○○○○○○○ 1 ○○○○○○○○ ○○○○○○○○ ○○○○○○○○                     </pre>		f/4	<pre> ○○○○○○○○ 1 ○○○○○○○○ ○○○○○○○○ ○○○○○○○○                     </pre>
TC-17E II	f/2.8 or faster	<pre> ○○○○○○○○ ○○○○○○○○ ○○○○○○○○ ○○○○○○○○                     </pre>		f/5.6	— <sup>3</sup>
	f/4	<pre> ○○○○○○○○ 2 ○○○○○○○○ ○○○○○○○○ ○○○○○○○○                     </pre>	TC-800-1.25E ED	f/5.6	<pre> ○○○○○○○○ 2 ○○○○○○○○ ○○○○○○○○ ○○○○○○○○                     </pre>
	f/5.6	— <sup>3</sup>			

- 1 Focus data for focus points other than the center focus point are obtained from line sensors.
- 2 Single-point AF is used when 3D-tracking or auto-area AF is selected for AF-area mode (□ 99).
- 3 Autofocus not available.



## **Lens f-number**

The f-number given in lens names is the maximum aperture of the lens.

## **Compatible Non-CPU Lenses**

When using non-CPU lenses and accessories, rotate the camera mode dial to **A** or **M** and set aperture using the lens aperture ring. In other modes, the shutter-release is disabled. **Non-CPU lens data** (□ 172) can be used to enable many of the features available with CPU lenses, including color matrix metering; if no data are provided, center-weighted metering will be used in place of color matrix metering, while if the maximum aperture is not provided, the camera aperture display will show the number of stops from maximum aperture and the actual aperture value must be read off the lens aperture ring.

## **Incompatible Accessories and Non-CPU Lenses**

The following can NOT be used with the D610:

- TC-16AS AF teleconverter
- Non-AI lenses
- Lenses that require the AU-1 focusing unit (400mm f/4.5, 600mm f/5.6, 800mm f/8, 1200mm f/11)
- Fisheye (6mm f/5.6, 7.5mm f/5.6, 8mm f/8, OP 10mm f/5.6)
- 2.1cm f/4
- Extension Ring K2
- 180–600mm f/8 ED (serial numbers 174041–174180)
- 360–1200mm f/11 ED (serial numbers 174031–174127)
- 200–600mm f/9.5 (serial numbers 280001–300490)
- AF lenses for the F3AF (AF 80mm f/2.8, AF 200mm f/3.5 ED, AF Teleconverter TC-16)
- PC 28mm f/4 (serial number 180900 or earlier)
- PC 35mm f/2.8 (serial numbers 851001–906200)
- PC 35mm f/3.5 (old type)
- Reflex 1000mm f/6.3 (old type)
- Reflex 1000mm f/11 (serial numbers 142361–143000)
- Reflex 2000mm f/11 (serial numbers 200111–200310)

## **The Built-in Flash**

The built-in flash can be used with CPU lenses with focal lengths of 24 mm (16 mm in DX format) to 300 mm, although in some cases the flash may be unable to entirely light the subject at some ranges or focal lengths due to shadows cast by the lens, while lenses that block the subject's view of the red-eye reduction lamp may interfere with red-eye reduction. Remove lens hoods to prevent shadows. The flash has a minimum range of 0.6 m (2 ft) and can not be used in the macro range of macro zoom lenses. The flash may be unable to light the entire subject with the following lenses at ranges less than those given below:

	<b>Lens</b>	<b>Zoom position</b>	<b>Minimum distance without vignetting</b>
DX	AF-S DX NIKKOR 10–24mm f/3.5–4.5G ED	18–24 mm	No vignetting
	AF-S DX Zoom-Nikkor 12–24mm f/4G IF-ED	18 mm	1.0 m/3 ft 3 in.
		20–24 mm	No vignetting

	Lens	Zoom position	Minimum distance without vignetting
DX	AF-S DX Zoom-Nikkor 17–55mm f/2.8G IF-ED	20 mm	2.0 m/6 ft 7 in.
		24–55 mm	1.0 m/3 ft 3 in.
	AF-S DX NIKKOR 18–200mm f/3.5–5.6G ED VR II	18 mm	1.0 m/3 ft 3 in.
	AF-S DX VR Zoom-Nikkor 18–200mm f/3.5–5.6G IF-ED	24–200 mm	No vignetting
		28 mm	1.0 m/3 ft 3 in.
AF-S DX NIKKOR 18–300mm f/3.5–5.6G ED VR	50–300 mm	No vignetting	
	35 mm	1.5 m/4 ft 11 in.	
X1	AF-S NIKKOR 16–35mm f/4G ED VR	28 mm	1.5 m/4 ft 11 in.
	AF-S Zoom-Nikkor 17–35mm f/2.8D IF-ED	35 mm	No vignetting
		24 mm	1.0 m/3 ft 3 in.
	AF Zoom-Nikkor 18–35mm f/3.5–4.5D IF-ED	28–35 mm	No vignetting
		28 mm	1.5 m/4 ft 11 in.
	AF-S NIKKOR 18–35mm f/3.5–4.5G ED	35 mm	No vignetting
		24 mm	1.5 m/4 ft 11 in.
	AF Zoom-Nikkor 20–35mm f/2.8D IF	28 mm	1.0 m/3 ft 3 in.
		35 mm	No vignetting
		24 mm	1.0 m/3 ft 3 in.
	AF-S NIKKOR 24mm f/1.4G ED	35 mm	1.5 m/4 ft 11 in.
	AF-S NIKKOR 24–70mm f/2.8G ED	50–70 mm	No vignetting
		24 mm	1.0 m/3 ft 3 in.
	AF-S VR Zoom-Nikkor 24–120mm f/3.5–5.6G IF-ED	35–120 mm	No vignetting
		24 mm	2.0 m/6 ft 7 in.
	AF-S NIKKOR 24–120mm f/4G ED VR	28 mm	1.0 m/3 ft 3 in.
		50–120 mm	No vignetting
AF-S Zoom-Nikkor 28–70mm f/2.8D IF-ED	28 mm	1.0 m/3 ft 3 in.	
	50–70 mm	No vignetting	
AF-S NIKKOR 28–300mm f/3.5–5.6G ED VR	28 mm	1.5 m/4 ft 11 in.	
	35 mm	1.0 m/3 ft 3 in.	
	50–300 mm	No vignetting	
PC-E NIKKOR 24mm f/3.5D ED *	24 mm	1.5 m/4 ft 11 in.	

\* When not shifted or tilted.

When used with the AF-S NIKKOR 14–24mm f/2.8G ED, the flash will be unable to light the entire subject at all ranges.

The built-in flash can also be used with AI-S, AI-, AI-modified NIKKOR, Nikon Series E and non-CPU lenses with a focal length of 24–300mm. AI 50–300mm f/4.5, modified AI 50–300mm f/4.5, AI-S 50–300mm f/4.5 ED, and AI 50–300mm f/4.5 ED lenses must be used at a zoom position of 70 mm or above. With AI-S and AI 25–50mm f/4 ED lenses, the ranges above which vignetting will not occur are: 2.0 m (6 ft 7 in.) at a zoom position of 25 mm and 1.0 m (3 ft 3 in.) at a zoom position of 28 mm; vignetting will not occur at zoom positions of 35 mm or above.



 **AF-Assist Illumination**

AF-assist illumination is not available with the following lenses:

- AF-S NIKKOR 200mm f/2G ED VR II
- AF-S VR Zoom-Nikkor 200–400mm f/4G IF-ED
- AF-S NIKKOR 200–400mm f/4G ED VR II
- AF-S NIKKOR 300mm f/2.8G ED VR II

At ranges under 0.7 m (2 ft 3 in.), the following lenses may block the AF-assist illuminator and interfere with autofocus when lighting is poor:

- AF-S NIKKOR 16–35mm f/4G ED VR
- AF-S Zoom-Nikkor 17–35mm f/2.8D IF-ED
- AF-S DX Zoom-Nikkor 17–55mm f/2.8G IF-ED
- AF-S DX VR Zoom-Nikkor 18–200mm f/3.5–5.6G IF-ED
- AF Zoom-Nikkor 20–35mm f/2.8D IF
- AF Zoom-Nikkor 24–85mm f/2.8–4D IF
- AF-S NIKKOR 24–85mm f/3.5–4.5G ED VR
- AF Zoom Nikkor 24–120mm f/3.5–5.6D (IF)
- AF-S NIKKOR 24–120mm f/4G ED VR
- AF-S NIKKOR 28–300mm f/3.5–5.6G ED VR
- AF-S NIKKOR 35mm f/1.4G
- AF Zoom Micro Nikkor ED 70–180mm f/4.5–5.6D
- AF-S VR Micro-Nikkor 105mm f/2.8G IF-ED

At ranges under 1.0 m (3 ft 3 in.), the following lenses may block the AF-assist illuminator and interfere with autofocus when lighting is poor:

- AF-S DX NIKKOR 18–200mm f/3.5–5.6G ED VR II
- AF-S NIKKOR 24–70mm f/2.8G ED
- AF-S VR Zoom-Nikkor 24–120mm f/3.5–5.6G IF-ED
- AF-S Zoom-Nikkor 28–70mm f/2.8D IF-ED
- AF Micro-Nikkor 200mm f/4D IF-ED

At ranges under 1.5 m (4 ft 11 in.), the following lenses may block the AF-assist illuminator and interfere with autofocus when lighting is poor:

- AF-S NIKKOR 14–24mm f/2.8G ED
- AF-S DX NIKKOR 18–300mm f/3.5–5.6G ED VR
- AF-S DX NIKKOR 55–300mm f/4.5–5.6G ED VR
- AF-S VR Zoom-Nikkor 70–200mm f/2.8G IF-ED
- AF-S NIKKOR 70–200mm f/2.8G ED VR II
- AF Zoom-Nikkor 80–200mm f/2.8D ED
- AF-S Zoom-Nikkor 80–200mm f/2.8D IF-ED





## Calculating Angle of View

The D610 can be used with Nikon lenses for 35mm (135) format cameras. If **Auto DX crop** is on ( 90) and a 35mm format lens is attached, the angle of view will be the same as a frame of 35mm film ( $35.9 \times 24.0$  mm); if a DX lens is attached, the angle of view will automatically be adjusted to  $23.5 \times 15.7$  mm (DX format).

If a 35 mm format lens is attached, the angle of view can be reduced by 1.5  $\times$  by turning **Auto DX crop** off and selecting **DX (24 $\times$ 16)**.

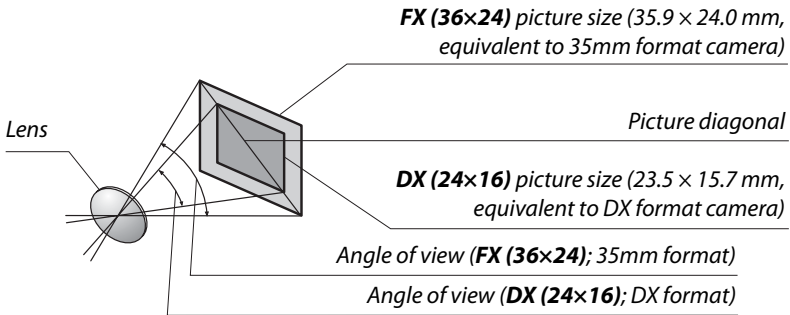

The **DX (24 $\times$ 16)** angle of view is about 1.5 times smaller than the 35mm format angle of view. To calculate the focal length of lenses in 35mm format when **DX (24 $\times$ 16)** is selected, multiply the focal length of the lens by about 1.5 (for example, the effective focal length of a 50mm lens in 35mm format would be 75 mm when **DX (24 $\times$ 16)** is selected).



# Optional Flash Units (Speedlights)

The camera supports the Nikon Creative Lighting System (CLS) and can be used with CLS-compatible flash units. Optional flash units can be attached directly to the camera accessory shoe as described below. The accessory shoe is equipped with a safety lock for flash units with a locking pin.

## 1 Remove the accessory shoe cover.

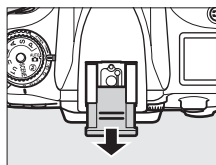

## 2 Mount the flash unit on the accessory shoe.

See the manual provided with the flash unit for details. The built-in flash will not fire when an optional flash unit is attached.

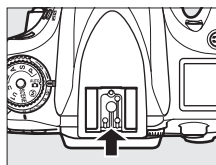

### **The AS-15 Sync Terminal Adapter**

When the AS-15 sync terminal adapter (available separately) is mounted on the camera accessory shoe, flash accessories can be connected via a sync terminal.

### **Use Only Nikon Flash Accessories**

*Use only Nikon flash units.* Negative voltages or voltages over 250 V applied to the accessory shoe could not only prevent normal operation, but damage the sync circuitry of the camera or flash. Before using a Nikon flash unit not listed in this section, contact a Nikon-authorized service representative for more information.

# The Nikon Creative Lighting System (CLS)

Nikon's advanced Creative Lighting System (CLS) offers improved communication between the camera and compatible flash units for improved flash photography. Refer to the documentation provided with the flash unit for details.

## ■ CLS-Compatible Flash Units

The camera can be used with the following CLS-compatible flash units:

- **The SB-910, SB-900, SB-800, SB-700, SB-600, SB-400, SB-300, and SB-R200:**

Feature \ Flash unit		Flash unit							
		SB-910 <sup>1</sup>	SB-900 <sup>1</sup>	SB-800	SB-700 <sup>1</sup>	SB-600	SB-400 <sup>2</sup>	SB-300 <sup>2</sup>	SB-R200 <sup>3</sup>
Guide No. <sup>4</sup>	ISO 100	34/111	34/111	38/125	28/92	30/98	21/69	18/59	10/33
	ISO 200	48/157	48/157	53/174	39/128	42/138	30/98	25/82	14/46

1 If a color filter is attached to the SB-910, SB-900, or SB-700 when AUTO or  (flash) is selected for white balance, the camera will automatically detect the filter and adjust white balance appropriately.

2 Wireless flash control is not available.

3 Controlled remotely with built-in flash in commander mode or using optional SB-910, SB-900, SB-800, or SB-700 flash unit or SU-800 wireless Speedlight commander.

4 m/ft, 20 °C (68 °F), SB-910, SB-900, SB-800, SB-700, and SB-600 at 35 mm zoom head position; SB-910, SB-900, and SB-700 with standard illumination.

- **SU-800 Wireless Speedlight Commander:** When mounted on a CLS-compatible camera, the SU-800 can be used as a commander for remote SB-910, SB-900, SB-800, SB-700, SB-600, or SB-R200 flash units in up to three groups. The SU-800 itself is not equipped with a flash.

### Guide Number

To calculate the range of the flash at full power, divide the Guide Number by the aperture. If, for example, the flash unit has a Guide Number of 34 m or 111 ft (ISO 100, 20 °C/68 °F); its range at an aperture of f/5.6 is  $34 \div 5.6$  or about 6.1 meters (or in feet,  $111 \div 5.6 =$  approximately 19 ft 10 in.). For each twofold increase in ISO sensitivity, multiply the Guide Number by the square root of two (approximately 1.4).



The following features are available with CLS-compatible flash units:

Flash unit		Advanced Wireless Lighting									
					Master/commander			Remote			
		SB-910			SB-400	SB-910			SB-910	SB-700	
Flash mode/feature	SB-910	SB-800	SB-700	SB-600	SB-300	SB-800	SB-700	SU-800 <sup>1</sup>	SB-800	SB-600	SB-R200
i-TTL	i-TTL balanced fill-flash for digital SLR	✓ <sup>2</sup>	✓ <sup>3</sup>	✓ <sup>2</sup>	✓ <sup>3</sup>	✓	✓	✓	✓	✓	✓
AA	Auto aperture	✓ <sup>4</sup>	—	—	—	✓ <sup>5</sup>	—	✓ <sup>5</sup>	✓ <sup>5</sup>	—	—
A	Non-TTL auto	✓ <sup>4</sup>	—	—	—	✓ <sup>5</sup>	—	—	✓ <sup>5</sup>	—	—
GN	Distance-priority manual	✓	✓	—	—	—	—	—	—	—	—
M	Manual	✓	✓	✓	✓ <sup>6</sup>	✓	✓	✓	✓	✓	✓
RPT	Repeating flash	✓	—	—	—	✓	—	✓	✓	✓	—
	Auto FP High-Speed Sync <sup>7</sup>	✓	✓	✓	—	✓	✓	✓	✓	✓	✓
	FV lock	✓	✓	✓	✓	✓	✓	✓	✓	✓	✓
	AF-assist for multi-area AF <sup>8</sup>	✓	✓	✓	—	✓	✓	✓	—	—	—
	Flash Color Information Communication	✓	✓	✓	✓	✓	✓	—	—	—	—
REAR	Rear-curtain sync	✓	✓	✓	✓	✓	✓	✓	✓	✓	✓
	Red-eye reduction	✓	✓	✓	✓ <sup>9</sup>	✓	✓	—	—	—	—
	Power zoom	✓	✓	✓	—	✓	✓	—	—	—	—

<sup>1</sup> Only available when SU-800 is used to control other flash units. The SU-800 itself is not equipped with a flash.

<sup>2</sup> Standard i-TTL flash for digital SLR is used with spot metering or when selected with flash unit.

<sup>3</sup> Standard i-TTL flash for digital SLR is used with spot metering.

<sup>4</sup> Selected with flash unit.

<sup>5</sup> Auto aperture (AA) is used regardless of mode selected with flash unit.

<sup>6</sup> Can be selected with camera.

<sup>7</sup> Select **1/250 s (Auto FP)** or **1/200 s (Auto FP)** for Custom Setting e1 (**Flash sync speed**, □ 234).

<sup>8</sup> CPU lens required.

<sup>9</sup> Not available with SB-300.

### Auto Aperture/Non-TTL Auto

Unless the focal length and maximum aperture are specified using the **Non-CPU lens data** option in the setup menu, choosing auto aperture (AA) when a non-CPU lens is attached automatically selects non-TTL auto (A).

## Other Flash Units













The following flash units can be used in non-TTL auto and manual modes.

Flash mode \ Flash unit	SB-80DX, SB-28DX, SB-28, SB-26, SB-25, SB-24	SB-50DX <sup>1</sup>	SB-30, SB-27 <sup>2</sup> , SB-22S, SB-22, SB-20, SB-16B, SB-15	SB-23, SB-29 <sup>3</sup> , SB-21B <sup>3</sup> , SB-29S <sup>3</sup>
<b>A</b> Non-TTL auto	✓	—	✓	—
<b>M</b> Manual	✓	✓	✓	✓
 Repeating flash	✓	—	—	—
<b>REAR</b> Rear-curtain sync <sup>4</sup>	✓	✓	✓	✓

- 1 Select mode **P**, **S**, **A**, or **M**, lower built-in flash, and use optional flash unit only.
- 2 Flash mode is automatically set to TTL and shutter-release is disabled. Set flash unit to **A** (non-TTL auto flash).
- 3 Autofocus is available with AF-S VR Micro-Nikkor 105mm f/2.8G IF-ED and AF-S Micro NIKKOR 60mm f/2.8G ED lenses only.
- 4 Available when camera is used to select flash mode.

### Flash Control Mode

The information display shows the flash control mode for optional flash units attached to the camera accessory shoe as follows:

	Flash sync	Auto FP (📖 234)
<b>i-TTL</b>		
<b>Auto aperture (AA)</b>		
<b>Non-TTL auto flash (A)</b>		
<b>Distance-priority manual (GN)</b>		
<b>Manual</b>		
<b>Repeating flash</b>		—
<b>Advanced wireless lighting</b>		

## ✓ Notes on Optional Flash Units

Refer to the Speedlight manual for detailed instructions. If the flash unit supports CLS, refer to the section on CLS-compatible digital SLR cameras. The D610 is not included in the “digital SLR” category in the SB-80DX, SB-28DX, and SB-50DX manuals.

If an optional flash unit is attached in shooting modes other than  $\text{Ⓢ}$ , the flash will fire with every shot, even in modes in which the built-in flash can not be used. Note that optional flash units can not be used in movie live view ( $\text{□}$  57) or while HDR is in effect ( $\text{□}$  139).

i-TTL flash control can be used at ISO sensitivities between 100 and 6400. At values over 6400, the desired results may not be achieved at some ranges or aperture settings. If the flash-ready indicator flashes for about three seconds after a photograph is taken, the flash has fired at full power and the photograph may be underexposed.

When an SC-series 17, 28, or 29 sync cable is used for off-camera flash photography, correct exposure may not be achieved in i-TTL mode. We recommend that you select standard i-TTL flash control. Take a test shot and view the results in the monitor.

In i-TTL, use the flash panel or bounce adapter provided with the flash unit. Do not use other panels such as diffusion panels, as this may produce incorrect exposure.

The SB-910, SB-900, SB-800, SB-700, SB-600, and SB-400 provide red-eye reduction, while the SB-910, SB-900, SB-800, SB-700, SB-600, and SU-800 provide AF-assist illumination with the following restrictions:

- **SB-910 and SB-900:** AF-assist illumination is available with 17–135 mm AF lenses, however, autofocus is available only with the focus points shown at right.

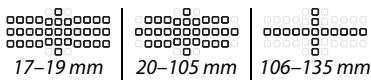

- **SB-800, SB-600, and SU-800:** AF-assist illumination is available with 24–105 mm AF lenses, however, autofocus is available only with the focus points shown at right.

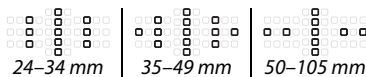

- **SB-700:** AF-assist illumination is available with 24–135 mm AF lenses, however, autofocus is available only with the focus points shown at right.

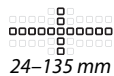

In mode **P**, the maximum aperture (minimum f-number) is limited according to ISO sensitivity, as shown below:

Maximum aperture at ISO equivalent of:						
100	200	400	800	1600	3200	6400
4	5	5.6	7.1	8	10	11

If the maximum aperture of the lens is smaller than given above, the maximum value for aperture will be the maximum aperture of the lens.

# Other Accessories

At the time of writing, the following accessories were available for the D610.

<b>Power sources</b>	<ul style="list-style-type: none"><li>• <b>Rechargeable Li-ion Battery EN-EL15</b> (□ 21, 23): Additional EN-EL15 batteries are available from local retailers and Nikon-authorized service representatives.</li><li>• <b>Battery Charger MH-25</b> (□ 21): Recharge EN-EL15 batteries.</li><li>• <b>Multi-Power Battery Pack MB-D14</b>: The MB-D14 is equipped with a shutter-release button, AE/AF lock button, multi selector, and main- and sub-command dials for improved operation when taking photographs in portrait (tall) orientation. When attaching the MB-D14, remove the camera MB-D14 contact cover.</li><li>• <b>Power Connector EP-5B, AC Adapter EH-5b</b>: These accessories can be used to power the camera for extended periods (EH-5a and EH-5 AC adapters can also be used). The EP-5B is required to connect the camera to the EH-5b; see page 299 for details. Note that when the camera is used with an MB-D14, the EP-5B must be inserted into the MB-D14, not the camera. Do not attempt to use the camera with power connectors inserted into both the camera and MB-D14.</li></ul>
<b>Filters</b>	<ul style="list-style-type: none"><li>• Filters intended for special-effects photography may interfere with autofocus or the electronic rangefinder.</li><li>• The D610 can not be used with linear polarizing filters. Use C-PL or C-PL II circular polarizing filters instead.</li><li>• Use NC filters to protect the lens.</li><li>• To prevent ghosting, use of a filter is not recommended when the subject is framed against a bright light, or when a bright light source is in the frame.</li><li>• Center-weighted metering is recommended with filters with exposure factors (filter factors) over <math>1 \times</math> (Y44, Y48, Y52, O56, R60, X0, X1, C-PL, ND2S, ND4, ND4S, ND8, ND8S, ND400, A2, A12, B2, B8, B12). See the filter manual for details.</li></ul>
<b>Viewfinder eyepiece accessories</b>	<ul style="list-style-type: none"><li>• <b>DK-20C Eyepiece Correction Lenses</b>: Lenses are available with diopters of <math>-5</math>, <math>-4</math>, <math>-3</math>, <math>-2</math>, <math>0</math>, <math>+0.5</math>, <math>+1</math>, <math>+2</math>, and <math>+3 \text{ m}^{-1}</math> when the camera diopter adjustment control is in the neutral position (<math>-1 \text{ m}^{-1}</math>). Use eyepiece correction lenses only if the desired focus can not be achieved with the built in diopter adjustment control (<math>-3</math> to <math>+1 \text{ m}^{-1}</math>). Test eyepiece correction lenses before purchase to ensure that the desired focus can be achieved. The rubber eyecup can not be used with eyepiece correction lenses.</li><li>• <b>Magnifying Eyepiece DK-21M</b>: The DK-21M magnifies the view through the viewfinder by approximately <math>1.17 \times</math> (50 mm f/1.4 lens at infinity; <math>-1.0 \text{ m}^{-1}</math>) for greater precision when framing.</li><li>• <b>Magnifier DG-2</b>: The DG-2 magnifies the scene displayed in the center of the viewfinder for greater precision during focusing. Eyepiece adapter required (available separately).</li><li>• <b>Eyepiece Adapter DK-22</b>: The DK-22 is used when attaching the DG-2 magnifier.</li><li>• <b>Right-Angle Viewing Attachment DR-6</b>: The DR-6 attaches at a right angle to the viewfinder eyepiece, allowing the image in the viewfinder to be viewed at right angles to the lens (for example, from directly above when the camera is horizontal).</li></ul>

Availability may vary with country or region. See our website or brochures for the latest information.

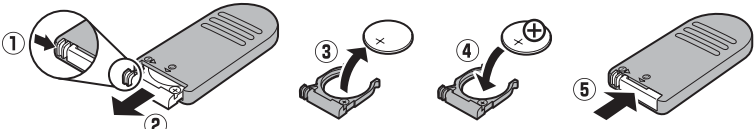
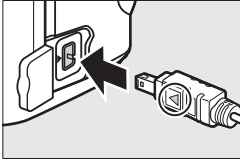

<b>Software</b>	<ul style="list-style-type: none"> <li>• <b>Capture NX 2:</b> A complete photo editing package with such advanced editing features as selection control points and an auto retouch brush.</li> <li>• <b>Camera Control Pro 2:</b> Control the camera remotely from a computer to record movies and photographs and save photographs directly to the computer hard disk.</li> </ul> <p><b>Note:</b> Use the latest versions of Nikon software; see the websites listed on page xxiii for the latest information on supported operating systems. At default settings, Nikon Message Center 2 will periodically check for updates to Nikon software and firmware while you are logged in to an account on the computer and the computer is connected to the Internet. A message is automatically displayed when an update is found.</p>
<b>Body cap</b>	<p><b>Body Cap BF-1B/Body Cap BF-1A:</b> The body cap keeps the mirror, viewfinder screen, and low-pass filter free of dust when a lens is not in place.</p>
<b>Remote controls/ wireless remote controller</b>	<ul style="list-style-type: none"> <li>• <b>Wireless Remote Control ML-L3:</b> The ML-L3 uses a 3 V CR2025 battery.</li> </ul>  <p>Pressing the battery-chamber latch to the right (1), insert a fingernail into the gap and open the battery chamber (2). Ensure that the battery is inserted in the correct orientation (4).</p> <ul style="list-style-type: none"> <li>• <b>Wireless Remote Controller WR-R10/WR-T10:</b> When a WR-R10 wireless remote controller is attached, the camera can be controlled wirelessly using a WR-T10 wireless remote controller.</li> <li>• <b>Wireless Remote Controller WR-1:</b> WR-1 units are used in groups of two or more, with one functioning as a transmitter and the remaining units acting as receivers. The receivers are attached to the accessory terminals of one or more cameras, allowing the transmitter to be used to release the camera shutters.</li> </ul>
<b>Accessory terminal accessories</b>	<p>The D610 is equipped with an accessory terminal for <b>MC-DC2 remote cords</b> (□ 79) and <b>GP-1</b> and <b>GP-1A GPS units</b> (□ 175), which connect with the ◀ mark on the connector aligned with the ▶ next to the accessory terminal (close the camera connector cover when the terminal is not in use).</p> 
<b>Microphones</b>	<p><b>Stereo Microphone ME-1</b> (□ 61)</p>
<b>Wireless mobile adapters</b>	<p><b>Wireless Mobile Adapter WU-1b:</b> Supports two-way communication between the camera and smart devices running the Wireless Mobile Utility.</p>



# Attaching a Power Connector and AC Adapter

Turn the camera off before attaching an optional power connector and AC adapter.

## 1 Ready the camera.

Open the battery-chamber (1) and power connector (2) covers.

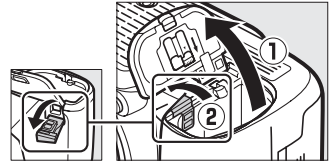

## 2 Insert the EP-5B power connector.

Be sure to insert the connector in the orientation shown, using the connector to keep the orange battery latch pressed to one side. The latch locks the connector in place when the connector is fully inserted.

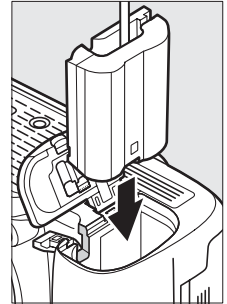

## 3 Close the battery-chamber cover.

Position the power connector cable so that it passes through the power connector slot and close the battery-chamber cover.

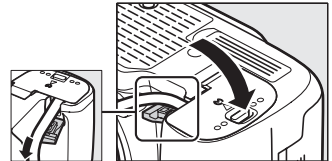

## 4 Connect the AC adapter.

Connect the AC adapter power cable to the AC socket on AC adapter (3) and the EP-5B power cable to the DC socket (4). A  icon is displayed in the monitor when the camera is powered by the AC adapter and power connector.

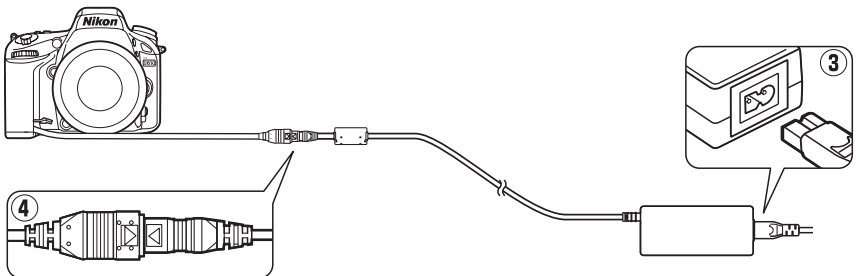

# Caring for the Camera

## Storage

When the camera will not be used for an extended period, replace the monitor cover, remove the battery, and store the battery in a cool, dry area with the terminal cover in place. To prevent mold or mildew, store the camera in a dry, well-ventilated area. Do not store your camera with naphtha or camphor moth balls or in locations that:

- are poorly ventilated or subject to humidities of over 60%
- are next to equipment that produces strong electromagnetic fields, such as televisions or radios
- are exposed to temperatures above 50 °C (122 °F) or below –10 °C (14 °F)

## Cleaning

<b>Camera body</b>	Use a blower to remove dust and lint, then wipe gently with a soft, dry cloth. After using the camera at the beach or seaside, wipe off sand or salt with a cloth lightly dampened in distilled water and dry thoroughly. <b>Important:</b> <i>Dust or other foreign matter inside the camera may cause damage not covered under warranty.</i>
<b>Lens, mirror, and viewfinder</b>	These glass elements are easily damaged. Remove dust and lint with a blower. If using an aerosol blower, keep the can vertical to prevent the discharge of liquid. To remove fingerprints and other stains, apply a small amount of lens cleaner to a soft cloth and clean with care.
<b>Monitor</b>	Remove dust and lint with a blower. When removing fingerprints and other stains, wipe the surface lightly with a soft cloth or chamois leather. Do not apply pressure, as this could result in damage or malfunction.

*Do not use alcohol, thinner, or other volatile chemicals.*

### **Servicing the Camera and Accessories**

The camera is a precision device and requires regular servicing. Nikon recommends that the camera be inspected by the original retailer or Nikon-authorized service representative once every one to two years, and that it be serviced once every three to five years (note that fees apply to these services). Frequent inspection and servicing are particularly recommended if the camera is used professionally. Any accessories regularly used with the camera, such as lenses or optional Speedlights, should be included when the camera is inspected or serviced.

# The Low-Pass Filter

The image sensor that acts as the camera's picture element is fitted with a low-pass filter to prevent moiré. If you suspect that dirt or dust on the filter is appearing in photographs, you can clean the filter using the **Clean image sensor** option in the setup menu. The filter can be cleaned at any time using the **Clean now** option, or cleaning can be performed automatically when the camera is turned on or off.

## ■ "Clean Now"

### 1 Select Clean image sensor in the setup menu.

Press the **MENU** button to display the menus. Highlight **Clean image sensor** in the setup menu and press **▶**.

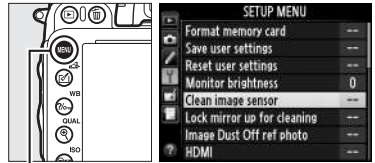

MENU button

### 2 Select Clean now.

The camera will check the image sensor and then begin cleaning. This process takes about 10 seconds; during this time, **buSy** flashes in the control panel and other operations can not be performed. Do not remove or disconnect the power source until cleaning is complete and **buSy** is no longer displayed.

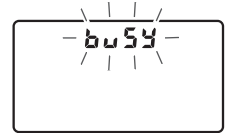

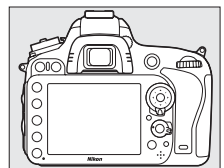

### Place the Camera Base Down

Image sensor cleaning is most effective when the camera is placed base down as shown at right.



## ■ ■ “Clean at Startup/Shutdown”

Choose from the following options:

Option	Description
 <b>Clean at startup</b>	The image sensor is automatically cleaned each time the camera is turned on.
 <b>Clean at shutdown</b>	The image sensor is automatically cleaned during shutdown each time the camera is turned off.
 <b>Clean at startup &amp; shutdown</b>	The image sensor is cleaned automatically at startup and at shutdown.
<b>Cleaning off</b>	Automatic image sensor cleaning off.

### 1 Select Clean at startup/shutdown.

Display the **Clean image sensor** menu as described in Step 2 on the previous page. Highlight **Clean at startup/shutdown** and press ►.



### 2 Select an option.

Highlight an option and press .

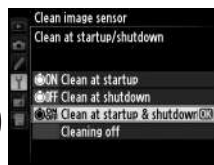

#### Image Sensor Cleaning

Using camera controls during startup interrupts image sensor cleaning. Image sensor cleaning may not be performed at startup if the flash is charging.

Cleaning is performed by vibrating the low-pass filter. If dust can not be fully removed using the options in the **Clean image sensor** menu, clean the image sensor manually (□ 303) or consult a Nikon-authorized service representative.

If image sensor cleaning is performed several times in succession, image sensor cleaning may be temporarily disabled to protect the camera's internal circuitry. Cleaning can be performed again after a short wait.

## Manual Cleaning

If foreign matter can not be removed from the low-pass filter using the **Clean image sensor** option in the setup menu (☐ 301), the filter can be cleaned manually as described below. Note, however, that the filter is extremely delicate and easily damaged. Nikon recommends that the filter be cleaned only by Nikon-authorized service personnel.

### 1 Charge the battery or connect an AC adapter.

A reliable power source is required when inspecting or cleaning the low-pass filter. Turn the camera off and insert a fully-charged EN-EL15 battery or connect an optional EP-5B power connector and EH-5b AC adapter. The **Lock mirror up for cleaning** option is only available in the setup menu at battery levels over .

### 2 Remove the lens.

Turn the camera off and remove the lens.

### 3 Select Lock mirror up for cleaning.

Turn the camera on and press the MENU button to display the menus. Highlight **Lock mirror up for cleaning** in the setup menu and press ►.



MENU button

### 4 Press .

The message shown at right will be displayed in the monitor and a row of dashes will appear in the control panel and viewfinder. To restore normal operation without inspecting the low-pass filter, turn the camera off.

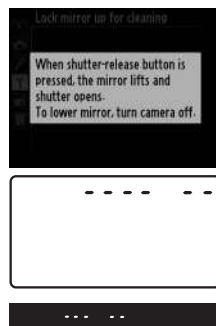

---

## 5 Raise the mirror.

Press the shutter-release button all the way down. The mirror will be raised and the shutter curtain will open, revealing the low-pass filter. The display in the viewfinder will turn off and the row of dashes in the control panel will flash.

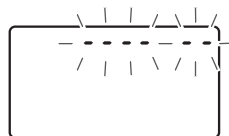

---

## 6 Examine the low-pass filter.

Holding the camera so that light falls on the low-pass filter, examine the filter for dust or lint. If no foreign objects are present, proceed to Step 8.

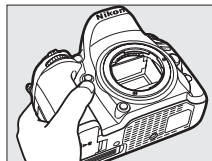

---

## 7 Clean the filter.

Remove any dust and lint from the filter with a blower. Do not use a blower-brush, as the bristles could damage the filter. Dirt that can not be removed with a blower can only be removed by Nikon-authorized service personnel. Under no circumstances should you touch or wipe the filter.

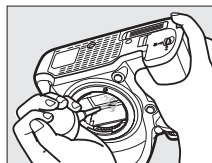

---

## 8 Turn the camera off.

The mirror will return to the down position and the shutter curtain will close. Replace the lens or body cap.

### **Use a Reliable Power Source**

The shutter curtain is delicate and easily damaged. If the camera powers off while the mirror is raised, the curtain will close automatically. To prevent damage to the curtain, observe the following precautions:

- Do not turn the camera off or remove or disconnect the power source while the mirror is raised.
- If the battery runs low while the mirror is raised, a beep will sound and the self-timer lamp will flash to warn that the shutter curtain will close and the mirror will be lowered after about two minutes. End cleaning or inspection immediately.

### **Foreign Matter on the Low-Pass Filter**

Nikon takes every possible precaution to prevent foreign matter from coming into contact with the low-pass filter during production and shipping. The D610, however, is designed to be used with interchangeable lenses, and foreign matter may enter the camera when lenses are removed or exchanged. Once inside the camera, this foreign matter may adhere to the low-pass filter, where it may appear in photographs taken under certain conditions. To protect the camera when no lens is in place, be sure to replace the body cap provided with the camera, being careful to first remove all dust and other foreign matter that may be adhering to the body cap. Avoid exchanging lenses in dusty environments.

Should foreign matter find its way onto the low-pass filter, clean the filter as described above, or have the filter cleaned by authorized Nikon service personnel. Photographs affected by the presence of foreign matter on the filter can be retouched using Capture NX 2 (available separately; □ 298) or the clean image options available in some third-party imaging applications.



# Caring for the Camera and Battery: Cautions

**Do not drop:** The product may malfunction if subjected to strong shocks or vibration.

**Keep dry:** This product is not waterproof, and may malfunction if immersed in water or exposed to high levels of humidity. Rusting of the internal mechanism can cause irreparable damage.

**Avoid sudden changes in temperature:** Sudden changes in temperature, such as those that occur when entering or leaving a heated building on a cold day, can cause condensation inside the device. To prevent condensation, place the device in a carrying case or plastic bag before exposing it to sudden changes in temperature.

**Keep away from strong magnetic fields:** Do not use or store this device in the vicinity of equipment that generates strong electromagnetic radiation or magnetic fields. Strong static charges or the magnetic fields produced by equipment such as radio transmitters could interfere with the monitor, damage data stored on the memory card, or affect the product's internal circuitry.

**Do not leave the lens pointed at the sun:** Do not leave the lens pointed at the sun or other strong light source for an extended period. Intense light may cause the image sensor to deteriorate or produce a white blur effect in photographs.

**Turn the product off before removing or disconnecting the power source:** Do not unplug the product or remove the battery while the product is on or while images are being recorded or deleted. Forcibly cutting power in these circumstances could result in loss of data or in damage to product memory or internal circuitry. To prevent an accidental interruption of power, avoid carrying the product from one location to another while the AC adapter is connected.

**Cleaning:** When cleaning the camera body, use a blower to gently remove dust and lint, then wipe gently with a soft, dry cloth. After using the camera at the beach or seaside, wipe off any sand or salt using a cloth lightly dampened in pure water and then dry the camera thoroughly. In rare instances, static electricity may cause LCDs to light up or go dark. This does not indicate a malfunction, and the display will soon return to normal.

The lens and mirror are easily damaged. Dust and lint should be gently removed with a blower. When using an aerosol blower, keep the can vertical to prevent discharge of liquid. To remove fingerprints and other stains from the lens, apply a small amount of lens cleaner to a soft cloth and wipe the lens carefully.

See "The Low-Pass Filter" (☞ 301, 303) for information on cleaning the low-pass filter.

**Lens contacts:** Keep the lens contacts clean.

**Do not touch the shutter curtain:** The shutter curtain is extremely thin and easily damaged. Under no circumstances should you exert pressure on the curtain, poke it with cleaning tools, or subject it to powerful air currents from a blower. These actions could scratch, deform, or tear the curtain.





**Storage:** To prevent mold or mildew, store the camera in a dry, well-ventilated area. If you are using an AC adapter, unplug the adapter to prevent fire. If the product will not be used for an extended period, remove the battery to prevent leakage and store the camera in a plastic bag containing a desiccant. Do not, however, store the camera case in a plastic bag, as this may cause the material to deteriorate. Note that desiccant gradually loses its capacity to absorb moisture and should be replaced at regular intervals.

To prevent mold or mildew, take the camera out of storage at least once a month. Turn the camera on and release the shutter a few times before putting it away.

Store the battery in a cool, dry place. Replace the terminal cover before putting the battery away.

**Notes on the monitor:** The monitor is constructed with extremely high precision; at least 99.99% of pixels are effective, with no more than 0.01% being missing or defective. Hence while these displays may contain pixels that are always lit (white, red, blue, or green) or always off (black), this is not a malfunction and has no effect on images recorded with the device.

Images in the monitor may be difficult to see in a bright light.

Do not apply pressure to the monitor, as this could cause damage or malfunction. Dust or lint on the monitor can be removed with a blower. Stains can be removed by wiping lightly with a soft cloth or chamois leather. Should the monitor break, care should be taken to avoid injury from broken glass and to prevent liquid crystal from the monitor touching the skin or entering the eyes and mouth.

Replace the monitor cover when transporting the camera or leaving it unattended.

**Batteries:** Batteries may leak or explode if improperly handled. Observe the following precautions when handling batteries:

- Use only batteries approved for use in this equipment.
- Do not expose the battery to flame or excessive heat.
- Keep the battery terminals clean.
- Turn the product off before replacing the battery.
- Remove the battery from the camera or charger when not in use and replace the terminal cover. These devices draw minute amounts of charge even when off and could draw the battery down to the point that it will no longer function. If the battery will not be used for some time, insert it in the camera and run it flat before removing it and storing it in a location with an ambient temperature of 15 to 25 °C (59 to 77 °F; avoid hot or extremely cold locations). Repeat this process at least once every six months.
- Turning the camera on or off repeatedly when the battery is fully discharged will shorten battery life. Batteries that have been fully discharged must be charged before use.
- The internal temperature of the battery may rise while the battery is in use. Attempting to charge the battery while the internal temperature is elevated will impair battery performance, and the battery may not charge or charge only partially. Wait for the battery to cool before charging.



- Continuing to charge the battery after it is fully charged can impair battery performance.
- A marked drop in the time a fully charged battery retains its charge when used at room temperature indicates that it requires replacement. Purchase a new EN-EL15 battery.
- Charge the battery before use. When taking photographs on important occasions, ready a spare EN-EL15 battery and keep it fully charged. Depending on your location, it may be difficult to purchase replacement batteries on short notice. Note that on cold days, the capacity of batteries tends to decrease. Be sure the battery is fully charged before taking photographs outside in cold weather. Keep a spare battery in a warm place and exchange the two as necessary. Once warmed, a cold battery may recover some of its charge.
- Used batteries are a valuable resource; recycle in accord with local regulations.



# Available Settings

The following table lists the settings that can be adjusted in each mode.

			<b>P</b>	<b>S, A, M</b>					
Storage folder	✓	✓	✓	✓	✓	✓	✓	✓	✓
File naming <sup>1</sup>	✓	✓	✓	✓	✓	✓	✓	✓	✓
Role played by card in Slot 2 <sup>1</sup>	✓	✓	✓	✓	✓	✓	✓	✓	✓
Image quality <sup>1,2</sup>	✓	✓	✓	✓	✓	✓	✓	✓	✓
Image size <sup>1,2</sup>	✓	✓	✓	✓	✓	✓	✓	✓	✓
Image area <sup>1</sup>	✓	✓	✓	✓	✓	✓	✓	✓	✓
JPEG compression <sup>1</sup>	✓	✓	✓	✓	✓	✓	✓	✓	✓
NEF (RAW) recording <sup>1</sup>	✓	✓	✓	✓	✓	✓	✓	✓	✓
White balance <sup>1,2</sup>	—	—	✓	✓	—	—	—	—	—
Set Picture Control <sup>1</sup>	—	—	✓	✓	—	—	—	—	—
Auto distortion control <sup>1</sup>	✓	✓	✓	✓	✓	✓	✓	✓	✓
Color space <sup>1</sup>	✓	✓	✓	✓	✓	✓	✓	✓	✓
Active D-Lighting <sup>1</sup>	— <sup>3</sup>	— <sup>3</sup>	✓ <sup>2</sup>	✓ <sup>2</sup>	— <sup>3</sup>	— <sup>3</sup>	— <sup>3</sup>	— <sup>3</sup>	—
HDR (high dynamic range) <sup>1,2</sup>	—	—	✓	✓	—	—	—	—	—
Vignette control <sup>1</sup>	✓	✓	✓	✓	✓	✓	✓	✓	✓
Long exposure NR <sup>1</sup>	✓	✓	✓	✓	✓	✓	✓	✓	✓
High ISO NR <sup>1</sup>	✓	✓	✓	✓	✓	✓	✓	✓	✓
ISO sensitivity settings <sup>1,2</sup>	✓ <sup>4</sup>	✓ <sup>4</sup>	✓	✓	✓ <sup>4</sup>	✓ <sup>4</sup>	✓ <sup>4</sup>	✓ <sup>4</sup>	✓ <sup>4</sup>
Remote control mode <sup>1</sup>	✓	✓	✓	✓	✓	✓	✓	✓	✓
Multiple exposure <sup>1,2</sup>	—	—	✓	✓	—	—	—	—	—
Interval timer shooting <sup>1</sup>	✓	✓	✓	✓	✓	✓	✓	✓	✓
Time-lapse photography <sup>1</sup>	✓	✓	✓	✓	✓	✓	✓	✓	✓
Movie settings <sup>1</sup>	✓	✓	✓	✓	✓	✓	✓	✓	✓
Autofocus mode (viewfinder)	✓ <sup>5</sup>	✓ <sup>5</sup>	✓	✓	✓ <sup>5</sup>	✓ <sup>5</sup>	✓ <sup>5</sup>	✓ <sup>5</sup>	✓ <sup>5</sup>
AF-area mode (viewfinder)	✓ <sup>5</sup>	✓ <sup>5</sup>	✓	✓	✓ <sup>5</sup>	✓ <sup>5</sup>	✓ <sup>5</sup>	✓ <sup>5</sup>	✓ <sup>5</sup>
AF mode (Live view/movie)	✓ <sup>5</sup>	✓ <sup>5</sup>	✓	✓	✓ <sup>5</sup>	✓ <sup>5</sup>	✓ <sup>5</sup>	✓ <sup>5</sup>	✓ <sup>5</sup>
AF-area mode (Live view/movie)	✓ <sup>5</sup>	✓ <sup>5</sup>	✓	✓	✓ <sup>5</sup>	✓ <sup>5</sup>	✓ <sup>5</sup>	✓ <sup>5</sup>	✓ <sup>5</sup>
AE lock hold	✓	✓	✓	✓	✓	✓	✓	✓	✓
Flexible program	—	—	✓	—	—	—	—	—	—
Metering	—	—	✓	✓	—	—	—	—	—
Exposure compensation	—	—	✓	✓	—	—	—	—	—
Bracketing	—	—	✓	✓	—	—	—	—	—
Flash mode	✓ <sup>5</sup>	—	✓	✓	✓ <sup>5</sup>	—	✓ <sup>5</sup>	—	—
Flash compensation	—	—	✓	✓	—	—	—	—	—
FV lock	✓	—	✓	✓	✓	—	✓	—	—

Shooting menu

Other settings<sup>2</sup>



			<b>P</b>	<b>S, A, M</b>					
a1: AF-C priority selection	✓	✓	✓	✓	✓	✓	✓	✓	✓
a2: AF-S priority selection	✓	✓	✓	✓	✓	✓	✓	✓	✓
a3: Focus tracking with lock-on	✓	✓	✓	✓	✓	✓	✓	✓	✓
a4: AF point illumination	✓	✓	✓	✓	✓	✓	✓	✓	✓
a5: Focus point wrap-around	✓	✓	✓	✓	✓	✓	✓	✓	✓
a6: Number of focus points	✓	✓	✓	✓	✓	✓	✓	✓	✓
a7: Built-in AF-assist illuminator	✓	✓	✓	✓	✓	—	—	✓	✓
b1: ISO sensitivity step value	✓	✓	✓	✓	✓	✓	✓	✓	✓
b2: EV steps for exposure cntrl	✓	✓	✓	✓	✓	✓	✓	✓	✓
b3: Easy exposure compensation	—	—	✓	✓	—	—	—	—	—
b4: Center-weighted area	—	—	✓	✓	—	—	—	—	—
b5: Fine-tune optimal exposure	✓	✓	✓	✓	✓	✓	✓	✓	✓
c1: Shutter-release button AE-L	✓	✓	✓	✓	✓	✓	✓	✓	✓
c2: Standby timer	✓	✓	✓	✓	✓	✓	✓	✓	✓
c3: Self-timer	✓	✓	✓	✓	✓	✓	✓	✓	✓
c4: Monitor off delay	✓	✓	✓	✓	✓	✓	✓	✓	✓
c5: Remote on duration	✓	✓	✓	✓	✓	✓	✓	✓	✓
d1: Beep	✓	✓	✓	✓	✓	✓	✓	✓	✓
d2: Viewfinder grid display	✓	✓	✓	✓	✓	✓	✓	✓	✓
d3: ISO display and adjustment	✓	✓	✓	✓	✓	✓	✓	✓	✓
d4: Screen tips	✓	✓	✓	✓	✓	✓	✓	✓	✓
d5: CL mode shooting speed	✓	✓	✓	✓	✓	✓	✓	✓	✓
d6: Max. continuous release	✓	✓	✓	✓	✓	✓	✓	✓	✓
d7: File number sequence	✓	✓	✓	✓	✓	✓	✓	✓	✓
d8: Information display	✓	✓	✓	✓	✓	✓	✓	✓	✓
d9: LCD illumination	✓	✓	✓	✓	✓	✓	✓	✓	✓
d10: Exposure delay mode <sup>2</sup>	✓	✓	✓	✓	✓	✓	✓	✓	✓
d11: Flash warning	—	—	✓	✓	—	—	—	—	—
d12: MB-D14 battery type	✓	✓	✓	✓	✓	✓	✓	✓	✓
d13: Battery order	✓	✓	✓	✓	✓	✓	✓	✓	✓

Custom Settings<sup>6</sup>

			<b>P</b>	<b>S, A, M</b>					
e1: Flash sync speed	✓	✓	✓	✓	✓	✓	✓	✓	✓
e2: Flash shutter speed	—	—	✓	✓	—	—	—	—	—
e3: Flash cntrl for built-in flash/ Optional flash	—	—	✓	✓	—	—	—	—	—
e4: Exposure comp. for flash	—	—	✓	✓	—	—	—	—	—
e5: Modeling flash	—	—	✓	✓	—	—	—	—	—
e6: Auto bracketing set	—	—	✓	✓	—	—	—	—	—
e7: Bracketing order	—	—	✓	✓	—	—	—	—	—
<b>Custom Settings<sup>6</sup></b>									
f1: OK button (shooting mode)	✓	✓	✓	✓	✓	✓	✓	✓	✓
f2: Assign Fn button	✓	✓	✓	✓	✓	✓	✓	✓	✓
f3: Assign preview button	✓	✓	✓	✓	✓	✓	✓	✓	✓
f4: Assign AE-L/AF-L button	✓	✓	✓	✓	✓	✓	✓	✓	✓
f5: Customize command dials	✓	✓	✓	✓	✓	✓	✓	✓	✓
f6: Release button to use dial	✓	✓	✓	✓	✓	✓	✓	✓	✓
f7: Slot empty release lock	✓	✓	✓	✓	✓	✓	✓	✓	✓
f8: Reverse indicators	✓	✓	✓	✓	✓	✓	✓	✓	✓
f9: Assign MB-D14  button	✓	✓	✓	✓	✓	✓	✓	✓	✓
g1: Assign Fn button	✓	✓	✓	✓	✓	✓	✓	✓	✓
g2: Assign preview button	✓	✓	✓	✓	✓	✓	✓	✓	✓
g3: Assign AE-L/AF-L button	✓	✓	✓	✓	✓	✓	✓	✓	✓
g4: Assign shutter button	✓	✓	✓	✓	✓	✓	✓	✓	✓

1 Reset with **Reset shooting menu** (□ 214).

2 Reset with two-button reset (□ 151).

3 Fixed at **Auto**.

4 **Auto ISO sensitivity control** is not available.

5 Reset when mode dial is rotated to new setting.

6 Reset with **Reset custom settings** (□ 221).



# Defaults



The default settings for the options in the camera menus are listed below. For information on two-button resets, see page 151.

## ■ Playback Menu Defaults

Option	Default	📖
Playback folder	ND610	207
Image review	Off	212
After delete	Show next	212
Rotate tall	On	212

Option	Default	📖
Slide show		
Image type	Still images and movies	213
Frame interval	2 s	

## ■ Shooting Menu Defaults <sup>1</sup>

Option	Default	📖
File naming	DSC	216
Role played by card in Slot 2	Overflow	96
Image quality	JPEG normal	93
Image size	Large	95
Image area		
Auto DX crop	On	89
Choose image area	FX (36×24)	90
JPEG compression	Size priority	94
NEF (RAW) recording		
Type	Lossless compressed	94
NEF (RAW) bit depth	14-bit	
White balance	Auto > Normal	115
Fine-tuning	A-B: 0, G-M: 0	117
Choose color temp.	5000 K	120
Preset manual	d-1	121
Set Picture Control	Standard	129
Auto distortion control	Off	217
Color space	sRGB	217
Active D-Lighting		
<b>P, S, A, M</b> ,   	Off	137
Other modes	Auto	
HDR (high dynamic range)		
HDR mode	Off	140
Exposure differential	Auto	140
Smoothing	Normal	141

Option	Default	📖
Vignette control	Normal	218
Long exposure NR	Off	218
High ISO NR	Normal	218
ISO sensitivity settings		
ISO sensitivity		
<b>P, S, A, M</b>	100	105
Other modes	Auto	
Auto ISO sensitivity control	Off	107
Remote control mode	Delayed remote	85
Multiple exposure <sup>2</sup>		
Multiple exposure mode	Off	160
Number of shots	2	161
Auto gain	On	162
Interval timer shooting	Reset <sup>3</sup>	164
Time-lapse photography	Reset <sup>4</sup>	168
Movie settings		
Frame size/frame rate	1920×1080; 30p	65
Movie quality	High quality	
Microphone	Auto sensitivity	
Destination	Slot 1	

1 Default settings restored with **Reset shooting menu** (📖 214).



2 **Reset shooting menu** can not be selected while shooting is in progress.

3 Start time reset to **Now**, interval reset to 1 minute, number of intervals and number of shots reset to 1, and **Start** set to **Off**. Shooting ends when reset is performed.

4 Interval reset to 5 s, recording time to 25 minutes.

## ■ Custom Settings Menu Defaults \*

	Option	Default	
a1	AF-C priority selection	Release	221
a2	AF-S priority selection	Focus	221
a3	Focus tracking with lock-on	3 (Normal)	222
a4	AF point illumination	Auto	222
a5	Focus point wrap-around	No wrap	222
a6	Number of focus points	39 points	223
a7	Built-in AF-assist illuminator	On	223
b1	ISO sensitivity step value	1/3 step	224
b2	EV steps for exposure cntrl	1/3 step	224
b3	Easy exposure compensation	Off	225
b4	Center-weighted area	ø 12 mm	226
b5	Fine-tune optimal exposure		
	Matrix metering	0	226
	Center-weighted metering	0	
	Spot metering	0	
c1	Shutter-release button AE-L	Off	226
c2	Standby timer	6 s	227
c3	Self-timer		
	Self-timer delay	10 s	227
	Number of shots	1	
	Interval between shots	0.5 s	
c4	Monitor off delay		
	Playback	10 s	228
	Menus	1 min	
	Information display	10 s	
	Image review	4 s	
	Live view	10 min	
c5	Remote on duration	1 min	228
d1	Beep		
	Volume	Off	228
	Pitch	High	
d2	Viewfinder grid display	Off	229
d3	ISO display and adjustment	Show frame count	229
d4	Screen tips	On	229
d5	CL mode shooting speed	3 fps	229
d6	Max. continuous release	100	230
d7	File number sequence	On	230

	Option	Default	
d8	Information display	Auto	231
d9	LCD illumination	Off	231
d10	Exposure delay mode	Off	231
d11	Flash warning	On	231
d12	MB-D14 battery type	LR6 (AA alkaline)	232
d13	Battery order	Use MB-D14 batteries first	233
e1	Flash sync speed	1/200 s	234
e2	Flash shutter speed	1/60 s	235
e3	Flash cntrl for built-in flash/Optional flash	TTL	236
e4	Exposure comp. for flash	Entire frame	240
e5	Modeling flash	On	241
e6	Auto bracketing set	AE & flash	241
e7	Bracketing order	MTR > under > over	241
f1	OK button (shooting mode)	Select center focus point	241
f2	Assign Fn button	Choose image area	242
f3	Assign preview button	Preview	244
f4	Assign AE-L/AF-L button	AE/AF lock	244
f5	Customize command dials		
	Reverse rotation	Exposure compensation: <input type="checkbox"/> Shutter speed/aperture: <input type="checkbox"/>	245
	Change main/sub	Off	
	Aperture setting	Sub-command dial	
	Menus and playback	Off	
f6	Release button to use dial	No	246
f7	Slot empty release lock	Enable release	246
f8	Reverse indicators		246
f9	Assign MB-D14  button	AE/AF lock	247
g1	Assign Fn button	None	247
g2	Assign preview button	Index marking	248
g3	Assign AE-L/AF-L button	AE/AF lock	248
g4	Assign shutter button	Take photos	248

\* Default settings restored with **Reset custom settings** ( 221).



## ■ ■ Setup Menu Defaults

Option	Default	
Save user settings		
Save to U1	Shooting mode defaults to <b>P</b>	81
Save to U2		
Monitor brightness		
Manual	0	250
Clean image sensor		
Clean at startup/shutdown	Clean at startup & shutdown	301
HDMI		
Output resolution	Auto	205
Device control	On	

Option	Default	
Flicker reduction	Auto	252
Time zone and date		
Daylight saving time	Off	253
Auto image rotation	On	254
GPS		
Standby timer	Enable	175
Use GPS to set camera clock	Yes	
Eye-Fi upload	Enable	260





# Exposure Program (Mode P)

The exposure program for mode **P** is shown in the following graph:

— ISO 100; lens with maximum aperture of f/1.4 and minimum aperture of f/16 (e.g., AF-S NIKKOR 50mm f/1.4G)

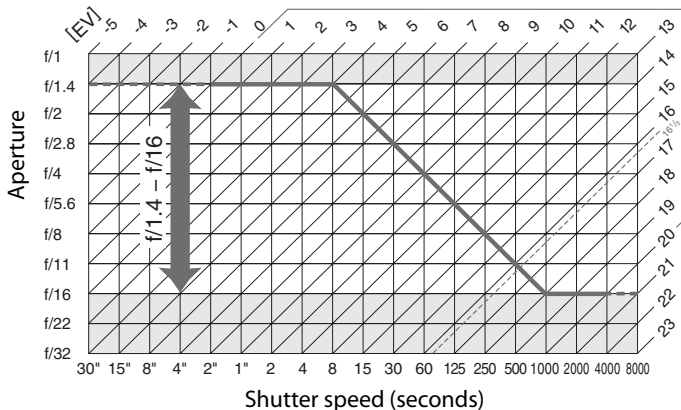

The maximum and minimum values for EV vary with ISO sensitivity; the above graph assumes an ISO sensitivity of ISO 100 equivalent. When matrix metering is used, values over  $16\frac{1}{3}$  EV are reduced to  $16\frac{1}{3}$  EV.



# Troubleshooting

If the camera fails to function as expected, check the list of common problems below before consulting your retailer or Nikon-authorized service representative.

## Battery/Display

---

**The camera is on but does not respond:** Wait for recording to end. If the problem persists, turn the camera off. If the camera does not turn off, remove and reinsert the battery or, if you are using an AC adapter, disconnect and reconnect the AC adapter. Note that although any data currently being recorded will be lost, data that have already been recorded will not be affected by removing or disconnecting the power source.

---

**Viewfinder is out of focus:** Adjust viewfinder focus or use optional eyepiece correction lenses (☐ 33, 297).

---

**Viewfinder is dark:** Insert a fully-charged battery (☐ 21, 35).

---

**Displays turn off without warning:** Choose longer delays for Custom Setting c2 (**Standby timer**) or c4 (**Monitor off delay**) (☐ 227, 228).

---

**Control panel and viewfinder displays are unresponsive and dim:** The response times and brightness of these displays vary with temperature.

---

**Fine lines are visible around active focus point or display turns red when focus point is highlighted:** These phenomena are normal for this type of viewfinder and do not indicate a malfunction.

---



# Shooting (All Modes)

---

**Camera takes time to turn on:** Delete files or folders.

---

**Shutter-release disabled:**

- Memory card is locked, full, or not inserted (☐ 29, 31).
  - **Release locked** is selected for Custom Setting f7 (**Slot empty release lock**; ☐ 246) and no memory card is inserted (☐ 32).
  - Built-in flash is charging (☐ 39).
  - Camera is not in focus (☐ 38).
  - CPU lens with aperture ring attached but aperture not locked at highest f-number. If **fE E** is displayed in control panel, select **Aperture ring** for Custom Setting f5 (**Customize command dials**) > **Aperture setting** to use lens aperture ring to adjust aperture (☐ 245).
  - Non-CPU lens is attached but camera is not in mode **A** or **M** (☐ 288).
- 

**Camera is slow to respond to shutter-release button:** Select **Off** for Custom Setting d10 (**Exposure delay mode**; ☐ 231).

---

**No photo taken when remote control shutter-release button is pressed:**

- Replace battery in remote control (☐ 298).
  - Choose remote control release mode (☐ 85).
  - Flash is charging (☐ 87).
  - Time selected for Custom Setting c5 (**Remote on duration**, ☐ 228) has elapsed: press camera shutter-release button halfway.
  - Bright light is interfering with remote.
- 

**Photos are out of focus:**

- Rotate focus-mode selector to **AF** (☐ 97).
  - Camera unable to focus using autofocus: use manual focus or focus lock (☐ 102, 103).
- 

**Focus does not lock when shutter-release button is pressed halfway:** Use **AE-L/AF-L** button to lock focus when **AF-C** is selected for focus mode or when photographing moving subjects in **AF-A** mode.

---

**Can not select focus point:**

- Unlock focus selector lock (☐ 101).
  - Auto-area AF or face-priority AF selected for AF-area mode: choose another mode.
  - Camera is in playback mode (☐ 177) or menus are in use (☐ 207).
  - Press shutter-release button halfway to turn monitor off or start standby timer (☐ 39).
- 

**Can not select AF-area mode:** Manual focus selected (☐ 55, 103).

---

**Only one shot taken each time shutter-release button is pressed in continuous release mode:** Continuous shooting is not available if built-in flash fires (☐ 145).

---

**Image size can not be changed:** **Image quality** set to **NEF (RAW)** (☐ 93).

---

**Camera is slow to record photos:** Turn long exposure noise reduction off (☐ 218).

---



---

**Noise (bright spots, randomly-spaced bright pixels, fog, or lines) appear in photos:**

- Choose lower ISO sensitivity or use high ISO noise reduction (☐ 105, 218).
- Shutter speed is slower than 1 s: use long exposure noise reduction (☐ 218).
- Turn Active D-Lighting off to avoid heightening the effects of noise (☐ 137).

---

**AF-assist illuminator does not light:**

- AF-assist lamp does not light if **AF-C** is selected for autofocus mode (☐ 97) or if continuous-servo autofocus is selected when the camera is in **AF-A** mode. Choose **AF-S**. If an option other than auto-area AF is selected for AF-area mode, select center focus point (☐ 99, 101).
- The camera is currently in live view or a movie is being recorded.
- **Off** selected for Custom Setting a7 (**Built-in AF-assist illuminator**) (☐ 223).
- Illuminator has turned off automatically. Illuminator may become hot with continued use; wait for lamp to cool down.

---

**Smudges appear in photographs:** Clean front and rear lens elements. If problem persists, perform image sensor cleaning (☐ 301).

---

**Sound is not recorded with movies:** **Microphone off** is selected for **Movie settings > Microphone**.

---

**The brightness of the image in the monitor differs from the exposure of photographs taken in live view:**

- Center-weighted or spot metering is selected (☐ 109).
- The camera is in mode **M**.
- The subject is too bright or too dark.
- Active D-Lighting is in effect (☐ 137).
- The photograph is a long time-exposure (☐ 79).
- The flash is used (☐ 143).

---

**Flicker or banding appears during live view or movie recording:** Choose an option for **Flicker reduction** that matches the frequency of the local AC power supply (☐ 252).

---

**Bright bands appear during live view or movie recording:** A flashing sign, flash, or other light source with brief duration was used during live view or movie recording.

---

**Menu item can not be selected:** Some options are not available in all modes.

---



# Shooting (P, S, A, M)

---

## Shutter-release disabled:

- Non-CPU lens is attached: rotate camera mode dial to **A** or **M** (□ 288).
- Mode dial rotated to **S** after shutter speed of **1/2** selected in mode **M**: choose new shutter speed (□ 76).

---

**Full range of shutter speeds not available:** Flash in use. Flash sync speed can be selected using Custom Setting e1 (**Flash sync speed**); when using compatible flash units, choose **1/250 s (Auto FP)** or **1/200 s (Auto FP)** for full range of shutter speeds (□ 234).

---

## Colors are unnatural:

- Adjust white balance to match light source (□ 115).
- Adjust **Set Picture Control** settings (□ 129).

---

**Can not measure white balance:** Subject is too dark or too bright (□ 123).

---

**Image can not be selected as source for preset white balance:** Image was not created with D610 (□ 124).

---

## White balance bracketing unavailable:

- NEF (RAW) or NEF+JPEG image quality option selected for image quality (□ 93).
- Multiple exposure mode is in effect (□ 163).

---

**Effects of Picture Control differ from image to image:** **A** (auto) is selected for sharpening, contrast, or saturation. For consistent results over a series of photos, choose another setting (□ 132).

---

**Metering can not be changed:** Autoexposure lock or movie live view is in effect (□ 57, 110).

---

**Exposure compensation can not be used:** Choose mode **P**, **S**, or **A** (□ 75, 76, 77).

---

**Noise (reddish areas or other artifacts) appears in long time-exposures:** Enable long exposure noise reduction (□ 218).

---



# Playback

---

**NEF (RAW) image is not played back:** Photo was taken at image quality of NEF + JPEG (☐ 93).

---

**Can not view pictures recorded with other cameras:** Pictures recorded with other makes of camera may not be displayed correctly.

---

**Message is displayed stating that no images are available for playback:** Select **All** for **Playback folder** (☐ 207).

---

**“Tall” (portrait) orientation photos are displayed in “wide” (landscape) orientation:**

- Select **On** for **Rotate tall** (☐ 212).
  - Photo was taken with **Off** selected for **Auto image rotation** (☐ 254).
  - Camera was pointed up or down when photo was taken (☐ 254).
  - Photo is displayed in image review (☐ 212).
- 

**Can not delete picture:**

- Picture is protected: remove protection (☐ 188).
  - Memory card is locked (☐ 32).
- 

**Can not retouch picture:** Photo can not be further edited with this camera (☐ 262).

---

**Can not change print order:**

- Memory card is full: delete pictures (☐ 36, 189).
  - Memory card is locked (☐ 32).
- 

**Can not select photo for printing:** Photo is in NEF (RAW) format. Create JPEG copy using **NEF (RAW) processing** or transfer to computer and print using ViewNX 2 (supplied) or Capture NX 2 (available separately).

---

**Picture is not displayed on TV:**

- Choose correct video mode (☐ 65) or output resolution (☐ 205).
  - HDMI (☐ 204) cable is not correctly connected.
- 

**Camera does not respond to remote control for HDMI-CEC television:**

- Select **On** for **HDMI > Device control** in the setup menu (☐ 205).
  - Adjust HDMI-CEC settings for the television as described in documentation provided with the device.
- 

**Can not transfer photos to computer:** OS not compatible with camera or transfer software. Use card reader to copy photos to computer (☐ 193).

---

**Photos are not displayed in Capture NX 2:** Update to latest version (☐ 298).

---

**Image Dust Off option in Capture NX 2 does not have desired effect:** Image sensor cleaning changes the position of dust on the low-pass filter. Dust off reference data recorded before image sensor cleaning is performed can not be used with photographs taken after image sensor cleaning is performed. Dust off reference data recorded after image sensor cleaning is performed can not be used with photographs taken before image sensor cleaning is performed (☐ 252).

---

**Computer displays NEF (RAW) images differently from camera:** Third-party software does not display effects of Picture Controls, Active D-Lighting, or vignette control. Use ViewNX 2 (supplied) or optional Nikon software such as Capture NX 2 (available separately).

---



# Miscellaneous

---

**Date of recording is not correct:** Set camera clock (📖 27, 253).

---





**Menu item can not be selected:** Some options are not available at certain combinations of settings or when no memory card is inserted. Note that **Battery info** option is not available when camera is powered by an optional EP-5B power connector and EH-5b AC adapter (📖 255).

---



# Error Messages

This section lists the indicators and error messages that appear in the viewfinder, control panel, and monitor.

Indicator		Problem	Solution	📖
Control panel	Viewfinder			
FE E (flashes)		Lens aperture ring is not set to minimum aperture.	Set ring to minimum aperture (highest f-number).	26
		Low battery.	Ready a fully-charged spare battery.	21
 (flashes)	 (flashes)	<ul style="list-style-type: none"> <li>Battery exhausted.</li> <li>Battery can not be used.</li> <li>An extremely exhausted rechargeable Li-ion battery or a third-party battery is inserted either in the camera or in the optional MB-D14 battery pack.</li> </ul>	<ul style="list-style-type: none"> <li>Recharge or replace battery.</li> <li>Contact Nikon-authorized service representative.</li> <li>Replace the battery, or recharge the battery if the rechargeable Li-ion battery is exhausted.</li> </ul>	xxiii, 21, 23
ΔF		No lens attached, or non-CPU lens attached without specifying maximum aperture. Aperture shown in stops from maximum aperture.	Aperture value will be displayed if maximum aperture is specified.	172
—	▶ ◀ (flashes)	Camera unable to focus using autofocus.	Change composition or focus manually.	98, 103
F- - (flashes)		<ul style="list-style-type: none"> <li>No lens attached.</li> <li>Non-CPU lens attached.</li> </ul>	<ul style="list-style-type: none"> <li>Attach non-IX Nikkor lens. If a CPU lens is attached, remove and reattach the lens.</li> <li>Select mode <b>A</b> or <b>M</b>.</li> </ul>	25, 285  288





Indicator		Problem	Solution	📖
Control panel	Viewfinder			
(Exposure indicators and shutter speed or aperture display flash)		Subject too bright; photo will be overexposed.	<ul style="list-style-type: none"> <li>• Use a lower ISO sensitivity</li> <li>• In shooting mode:               <ul style="list-style-type: none"> <li><b>P</b> Use optional ND filter</li> <li><b>S</b> Increase shutter speed</li> <li><b>A</b> Choose a smaller aperture (higher f-number)</li> </ul> </li> </ul>	105 297 76 77
		Subject too dark; photo will be underexposed.	<ul style="list-style-type: none"> <li>• Use a higher ISO sensitivity</li> <li>• In shooting mode:               <ul style="list-style-type: none"> <li><b>P</b> Use flash</li> <li><b>S</b> Lower shutter speed</li> <li><b>A</b> Choose a larger aperture (lower f-number)</li> </ul> </li> </ul>	105 143 76 77
<b>b u l b</b> (flashes)		<b>b u l b</b> selected in mode <b>S</b> .	Change shutter speed or select mode <b>M</b> .	76, 78
- - (flashes)		- - selected in mode <b>S</b> .	Change shutter speed or select mode <b>M</b> .	76, 78
<b>b u s y</b> (flashes)	<b>b s y</b> (flashes)	Images are being processed.	Wait until processing is complete.	—
—	<b>⚡</b> (flashes)	If indicator flashes for 3s after flash fires, photo may be underexposed.	Check photo in monitor; if underexposed, adjust settings and try again.	177
<b>F u l l</b> (flashes)	<b>F u l</b> (flashes)	Memory insufficient to record further photos at current settings, or camera has run out of file or folder numbers.	<ul style="list-style-type: none"> <li>• Reduce quality or size.</li> <li>• Delete photographs.</li> <li>• Insert new memory card.</li> </ul>	93, 95 189 29
<b>E r r</b> (flashes)		Camera malfunction.	Release shutter. If error persists or appears frequently, consult Nikon-authorized service representative.	—



Indicator		Problem	Solution	📖
Monitor	Control panel			
<b>No memory card.</b>	{ - E - }	Camera cannot detect memory card.	Turn camera off and confirm that card is correctly inserted.	29
<b>This memory card cannot be used. Card may be damaged. Insert another card.</b>	E R r d, E r r (flashes)	<ul style="list-style-type: none"> <li>• Error accessing memory card.</li> <li>• Unable to create new folder.</li> </ul>	<ul style="list-style-type: none"> <li>• Use Nikon-approved card.</li> <li>• Check that contacts are clean. If card is damaged, contact retailer or Nikon-authorized service representative.</li> <li>• Delete files or insert new memory card after copying important images to computer or other device.</li> </ul>	334 — 29, 189
	E R r d, E r r (flashes)	Camera can not control Eye-Fi card.	<ul style="list-style-type: none"> <li>• Check that Eye-Fi card firmware is up to date.</li> <li>• Copy files on Eye-Fi card to a computer or other device and format card, or insert new card.</li> </ul>	260 29, 31, 193
<b>Memory card is locked. Slide lock to “write” position.</b>	E R r d, - - - (flashes)	Memory card is locked (write protected).	Slide card write-protect switch to “write” position.	32
<b>Not available if Eye-Fi card is locked.</b>	E R r d, E r r (flashes)	Eye-Fi card is locked (write protected).		
<b>This card is not formatted. Format the card.</b>	[F o r] (flashes)	Memory card has not been formatted for use in camera.	Format memory card or insert new memory card.	29, 31
<b>Clock has been reset</b>	—	Camera clock is not set.	Set camera clock.	27, 253
<b>Failed to update flash unit firmware. Flash cannot be used. Contact a Nikon-authorized service representative.</b>	—	Firmware for flash unit mounted on camera was not updated correctly.	Contact a Nikon-authorized service representative.	—
<b>Unable to start live view. Please wait.</b>	—	The internal temperature of the camera is high.	Wait for the internal circuits to cool before resuming live view or movie recording.	64



Indicator		Problem	Solution	📖
Monitor	Control panel			
Folder contains no images.	—	No images on memory card or in folder(s) selected for playback.	Select folder containing images from <b>Playback folder</b> menu or insert memory card containing images.	29, 207
All images are hidden.	—	All photos in current folder are hidden.	No images can be played back until another folder has been selected or <b>Hide image</b> used to allow at least one image to be displayed.	208
Cannot display this file.	—	File has been created or modified using a computer or different make of camera, or file is corrupt.	File can not be played back on camera.	—
Cannot select this file.	—	Selected image can not be retouched.	Images created with other devices can not be retouched.	262
This movie cannot be edited.	—	The selected movie can not be edited.	<ul style="list-style-type: none"> <li>• Movies created with other devices can not be edited.</li> <li>• Movies must be at least two seconds long.</li> </ul>	— 71
Check printer.	—	Printer error.	Check printer. To resume, select <b>Continue</b> (if available).	196 *
Check paper.	—	Paper in printer is not of selected size.	Insert paper of correct size and select <b>Continue</b> .	196 *
Paper jam.	—	Paper is jammed in printer.	Clear jam and select <b>Continue</b> .	196 *
Out of paper.	—	Printer is out of paper.	Insert paper of selected size and select <b>Continue</b> .	196 *
Check ink supply.	—	Ink error.	Check ink. To resume, select <b>Continue</b> .	196 *
Out of ink.	—	Printer is out of ink.	Replace ink and select <b>Continue</b> .	196 *

\* See printer manual for more information.



# Specifications

## ■ Nikon D610 Digital Camera

<b>Type</b>	
Type	Single-lens reflex digital camera
Lens mount	Nikon F mount (with AF coupling and AF contacts)
Effective angle of view	Nikon FX format
<b>Effective pixels</b>	
Effective pixels	24.3 million
<b>Image sensor</b>	
Image sensor	35.9 × 24.0 mm CMOS sensor
Total pixels	24.7 million
Dust-reduction System	Image sensor cleaning, Image Dust Off reference data (optional Capture NX 2 software required)
<b>Storage</b>	
Image size (pixels)	<ul style="list-style-type: none"> <li>• <b>FX (36×24) image area</b> 6,016 × 4,016 (L)      4,512 × 3,008 (M)      3,008 × 2,008 (S)</li> <li>• <b>DX (24×16) image area</b> 3,936 × 2,624 (L)      2,944 × 1,968 (M)      1,968 × 1,312 (S)</li> <li>• <b>FX-format photographs taken in movie live view</b> 6,016 × 3,376 (L)      4,512 × 2,528 (M)      3,008 × 1,688 (S)</li> <li>• <b>DX-format photographs in movie live view</b> 3,936 × 2,224 (L)      2,944 × 1,664 (M)      1,968 × 1,112 (S)</li> </ul>
File format	<ul style="list-style-type: none"> <li>• <b>NEF (RAW)</b>: 12 or 14 bit, lossless compressed or compressed</li> <li>• <b>JPEG</b>: JPEG-Baseline compliant with fine (approx. 1 : 4), normal (approx. 1 : 8), or basic (approx. 1 : 16) compression (<b>Size priority</b>); <b>Optimal quality</b> compression available</li> <li>• <b>NEF (RAW)+JPEG</b>: Single photograph recorded in both NEF (RAW) and JPEG formats</li> </ul>
Picture Control System	Standard, Neutral, Vivid, Monochrome, Portrait, Landscape; selected Picture Control can be modified; storage for custom Picture Controls
Media	SD (Secure Digital) and UHS-I compliant SDHC and SDXC memory cards
Double slot	Slot 2 can be used for overflow or backup storage or for separate storage of copies created using NEF+JPEG; pictures can be copied between cards.
File system	DCF (Design Rule for Camera File System) 2.0, DPOF (Digital Print Order Format), Exif (Exchangeable Image File Format for Digital Still Cameras) 2.3, PictBridge
<b>Viewfinder</b>	
Viewfinder	Eye-level pentaprism single-lens reflex viewfinder
Frame coverage	<ul style="list-style-type: none"> <li>• <b>FX (36×24)</b>: Approx. 100% horizontal and 100% vertical</li> <li>• <b>DX (24×16)</b>: Approx. 97% horizontal and 97% vertical</li> </ul>
Magnification	Approx. 0.7 × (50 mm f/1.4 lens at infinity, -1.0 m <sup>-1</sup> )
Eyepoint	21 mm (-1.0 m <sup>-1</sup> ; from center surface of viewfinder eyepiece lens)



Viewfinder	
<b>Diopter adjustment</b>	-3 – +1 m <sup>-1</sup>
<b>Focusing screen</b>	Type B BriteView Clear Matte Mark VIII screen with AF area brackets (framing grid can be displayed)
<b>Reflex mirror</b>	Quick return
<b>Depth-of-field preview</b>	Pressing depth-of-field preview button stops lens aperture down to value selected by user ( <b>A</b> and <b>M</b> modes) or by camera (other modes)
<b>Lens aperture</b>	Instant return, electronically controlled
Lens	
<b>Compatible lenses</b>	<p>Compatible with AF NIKKOR lenses, including type G, E, and D lenses (some restrictions apply to PC lenses) and DX lenses (using DX 24 × 16 1.5× image area), AI-P NIKKOR lenses, and non-CPU AI lenses (<b>A</b> and <b>M</b> modes only). IX NIKKOR lenses, lenses for the F3AF, and non-AI lenses can not be used.</p> <p>The electronic rangefinder can be used with lenses that have a maximum aperture of f/5.6 or faster (the electronic rangefinder supports the center 7 focus points with lenses that have a maximum aperture of f/8 or faster and the center 33 focus points with lenses that have a maximum aperture of f/6.8 or faster)</p>
Shutter	
<b>Type</b>	Electronically-controlled vertical-travel focal-plane shutter
<b>Speed</b>	<sup>1</sup> / <sub>4000</sub> – 30 s in steps of <sup>1</sup> / <sub>3</sub> or <sup>1</sup> / <sub>2</sub> EV, bulb, time (requires optional ML-L3 remote control), X200
<b>Flash sync speed</b>	X = <sup>1</sup> / <sub>200</sub> s; synchronizes with shutter at <sup>1</sup> / <sub>250</sub> s or slower (flash range drops at speeds between <sup>1</sup> / <sub>200</sub> and <sup>1</sup> / <sub>250</sub> s)
Release	
<b>Release mode</b>	<b>S</b> (single frame), <b>CL</b> (continuous low speed), <b>CH</b> (continuous high speed), <b>Q</b> (quiet shutter-release), <b>Qc</b> (quiet continuous shutter-release), <b>☺</b> (self-timer), <b>☑</b> (remote control), <b>MUP</b> (mirror up)
<b>Frame advance rate</b>	1–5 fps ( <b>CL</b> ), 6 fps ( <b>CH</b> ), or 3 fps ( <b>Qc</b> )
<b>Self-timer</b>	2 s, 5 s, 10 s, 20 s; 1–9 exposures at intervals of 0.5, 1, 2, or 3 s
<b>Remote release modes</b>	Delayed remote, quick-response remote, remote mirror-up
Exposure	
<b>Metering</b>	TTL exposure metering using 2,016-pixel RGB sensor
<b>Metering method</b>	<ul style="list-style-type: none"> <li>• <b>Matrix:</b> 3D color matrix metering II (type G, E, and D lenses); color matrix metering II (other CPU lenses); color matrix metering available with non-CPU lenses if user provides lens data</li> <li>• <b>Center-weighted:</b> Weight of 75% given to 12 mm circle in center of frame. Diameter of circle can be changed to 8, 15, or 20 mm, or weighting can be based on average of entire frame (non-CPU lenses use 12-mm circle or average of entire frame)</li> <li>• <b>Spot:</b> Meters 4 mm circle (about 1.5% of frame) centered on selected focus point (on center focus point when non-CPU lens is used)</li> </ul>
<b>Range (ISO 100, f/1.4 lens, 20 °C/68 °F)</b>	<ul style="list-style-type: none"> <li>• <b>Matrix or center-weighted metering:</b> 0–20 EV</li> <li>• <b>Spot metering:</b> 2–20 EV</li> </ul>



Exposure	
<b>Exposure meter coupling</b>	Combined CPU and AI
<b>Mode</b>	Auto (📷 auto; ⏻ auto (flash off)); scene (👤 portrait; 🏞 landscape; 👦 child; 🏃 sports; 🌻 close up; 🌃 night portrait; 🌃 night landscape; 🎉 party/indoor; 🏖 beach/snow; 🌅 sunset; 🌄 dusk/dawn; 🐾 pet portrait; 🕯 candlelight; 🌸 blossom; 🍂 autumn colors; 🍷 food; 🖼 silhouette; 📷 high key; 📷 low key); programmed auto with flexible program (P); shutter-priority auto (S); aperture-priority auto (A); manual (M); <b>U1</b> (user settings 1); <b>U2</b> (user settings 2)
<b>Exposure compensation</b>	Can be adjusted by -5 +5 EV in increments of 1/3 or 1/2 EV in P, S, A, and M modes
<b>Exposure bracketing</b>	2–3 frames in steps of 1/3, 1/2, 2/3, 1, 2, or 3 EV
<b>Flash bracketing</b>	2–3 frames in steps of 1/3, 1/2, 2/3, 1, 2, or 3 EV
<b>White balance bracketing</b>	2–3 frames in steps of 1, 2, or 3
<b>ADL bracketing</b>	2 frames using selected value for one frame or 3 frames using preset values for all frames
<b>Exposure lock</b>	Luminosity locked at detected value with $\text{AE-L}$ <b>AE-L/AF-L</b> button
<b>ISO sensitivity (Recommended Exposure Index)</b>	ISO 100 – 6400 in steps of 1/3 or 1/2 EV. Can also be set to approx. 0.3, 0.5, 0.7, or 1 EV (ISO 50 equivalent) below ISO 100 or to approx. 0.3, 0.5, 0.7, 1, or 2 EV (ISO 25600 equivalent) above ISO 6400; auto ISO sensitivity control available
<b>Active D-Lighting</b>	<b>Auto, Extra high, High, Normal, Low, Off</b>
Focus	
<b>Autofocus</b>	Nikon Multi-CAM 4800 autofocus sensor module with TTL phase detection, fine-tuning, 39 focus points (including 9 cross-type sensors; the center 33 points are available at apertures slower than f/5.6 and faster than f/8, while the center 7 focus points are available at f/8), and AF-assist illuminator (range approx. 0.5–3 m/1 ft 8 in.–9 ft 10 in.)
<b>Detection range</b>	-1 +19 EV (ISO 100, 20 °C/68 °F)
<b>Lens servo</b>	<ul style="list-style-type: none"> <li>• <b>Autofocus (AF)</b>: Single-servo AF (<b>AF-S</b>); continuous-servo AF (<b>AF-C</b>); auto AF-S/AF-C selection (<b>AF-A</b>); predictive focus tracking activated automatically according to subject status</li> <li>• <b>Manual focus (M)</b>: Electronic rangefinder can be used</li> </ul>
<b>Focus point</b>	Can be selected from 39 or 11 focus points
<b>AF-area mode</b>	Single-point AF; 9-, 21-, or 39-point dynamic-area AF, 3D-tracking, auto-area AF
<b>Focus lock</b>	Focus can be locked by pressing shutter-release button halfway (single-servo AF) or by pressing $\text{AE-L}$ <b>AE-L/AF-L</b> button
Flash	
<b>Built-in flash</b>	📷 $\text{AE-L}$ , 📷, 📷, 📷, 📷, 📷, 📷: Auto flash with auto pop-up P, S, A, M, 📷: Manual pop-up with button release
<b>Guide Number</b>	Approx. 12/39, 12/39 with manual flash (m/ft, ISO 100, 20 °C/68 °F)



<b>Flash</b>	
<b>Flash control</b>	TTL: i-TTL flash control using 2,016-pixel RGB sensor is available with built-in flash and SB-910, SB-900, SB-800, SB-700, SB-600, SB-400, or SB-300; i-TTL balanced fill-flash for digital SLR is used with matrix and center-weighted metering, standard i-TTL flash for digital SLR with spot metering
<b>Flash mode</b>	Auto, auto with red-eye reduction, auto slow sync, auto slow sync with red-eye reduction, fill-flash, red-eye reduction, slow sync, slow sync with red-eye reduction, rear-curtain with slow sync, rear-curtain sync, off; Auto FP High-Speed Sync supported
<b>Flash compensation</b>	-3 – +1 EV in increments of $\frac{1}{3}$ or $\frac{1}{2}$ EV
<b>Flash-ready indicator</b>	Lights when built-in flash or optional flash unit is fully charged; flashes after flash is fired at full output
<b>Accessory shoe</b>	ISO 518 hot-shoe with sync and data contacts and safety lock
<b>Nikon Creative Lighting System (CLS)</b>	Advanced Wireless Lighting supported with built-in flash, SB-910, SB-900, SB-800, or SB-700 as a master flash and SB-600 or SB-R200 as remotes, or SU-800 as commander; built-in flash can serve as master flash in commander mode; Auto FP High-Speed Sync and modeling illumination supported with all CLS-compatible flash units except SB-400 and SB-300; Flash Color Information Communication and FV lock supported with all CLS-compatible flash units
<b>Sync terminal</b>	AS-15 sync terminal adapter (available separately)
<b>White balance</b>	
<b>White balance</b>	Auto (2 types), incandescent, fluorescent (7 types), direct sunlight, flash, cloudy, shade, preset manual (up to 4 values can be stored), choose color temperature (2500 K–10000 K), all with fine-tuning
<b>Live view</b>	
<b>Modes</b>	Live view photography (still images), movie live view (movies)
<b>Lens servo</b>	<ul style="list-style-type: none"> <li>• <b>Autofocus (AF):</b> Single-servo AF (<b>AF-S</b>); full-time servo AF (<b>AF-F</b>)</li> <li>• <b>Manual focus (M)</b></li> </ul>
<b>AF-area mode</b>	Face-priority AF, wide-area AF, normal-area AF, subject-tracking AF
<b>Autofocus</b>	Contrast-detect AF anywhere in frame (camera selects focus point automatically when face-priority AF or subject-tracking AF is selected)
<b>Movie</b>	
<b>Metering</b>	TTL exposure metering using main image sensor
<b>Metering method</b>	Matrix
<b>Frame size (pixels) and frame rate</b>	<ul style="list-style-type: none"> <li>• 1,920 × 1,080; 30 p (progressive), 25 p, 24 p</li> <li>• 1,280 × 720; 60 p, 50 p, 30 p, 25 p</li> </ul> <p>Actual frame rates for 60 p, 50 p, 30 p, 25 p, and 24 p are 59.94, 50, 29.97, 25, and 23.976 fps respectively; options support both ★high and normal image quality</p>
<b>File format</b>	MOV
<b>Video compression</b>	H.264/MPEG-4 Advanced Video Coding
<b>Audio recording format</b>	Linear PCM
<b>Audio recording device</b>	Built-in monaural or external stereo microphone; sensitivity adjustable
<b>Other options</b>	Index marking, time-lapse photography



<b>Monitor</b>	
<b>Monitor</b>	8-cm/3.2-in., approx. 921k-dot (VGA), low-temperature polysilicon TFT LCD with approx. 170° viewing angle, approx. 100% frame coverage, and automatic monitor brightness control using ambient brightness sensor
<b>Playback</b>	
<b>Playback</b>	Full-frame and thumbnail (4, 9, or 72 images or calendar) playback with playback zoom, movie playback, photo and/or movie slide shows, histogram display, highlights, photo information, GPS data display, and auto image rotation
<b>Interface</b>	
<b>USB</b>	Hi-Speed USB
<b>HDMI output</b>	Type C mini-pin HDMI connector
<b>Accessory terminal</b>	<b>Remote cord:</b> MC-DC2 (available separately) <b>GPS unit:</b> GP-1/GP-1A (available separately)
<b>Audio input</b>	Stereo mini-pin jack (3.5 mm diameter; plug-in power supported)
<b>Audio output</b>	Stereo mini-pin jack (3.5 mm diameter)
<b>Supported languages</b>	
<b>Supported languages</b>	Arabic, Chinese (Simplified and Traditional), Czech, Danish, Dutch, English, Finnish, French, German, Greek, Hindi, Hungarian, Indonesian, Italian, Japanese, Korean, Norwegian, Polish, Portuguese (Portugal and Brazil), Romanian, Russian, Spanish, Swedish, Thai, Turkish, Ukrainian
<b>Power source</b>	
<b>Battery</b>	One rechargeable Li-ion EN-EL15 battery
<b>Battery pack</b>	Optional MB-D14 multi-power battery pack with one rechargeable Nikon EN-EL15 Li-ion battery or six AA alkaline, Ni-MH, or lithium batteries
<b>AC adapter</b>	EH-5b AC adapter; requires EP-5B power connector (available separately)
<b>Tripod socket</b>	
<b>Tripod socket</b>	1/4 in. (ISO 1222)
<b>Dimensions/weight</b>	
<b>Dimensions (W × H × D)</b>	Approx. 141 × 113 × 82 mm (5.6 × 4.4 × 3.2 in.)
<b>Weight</b>	Approx. 850 g (1 lb 14.0 oz) with battery and memory card but without body cap; approx. 760 g (1 lb 10.8 oz; camera body only)
<b>Operating environment</b>	
<b>Temperature</b>	0 °C–40 °C (+32 °F–104 °F)
<b>Humidity</b>	85% or less (no condensation)

- Unless otherwise stated, all figures are for a camera with a fully-charged battery operating at the temperature specified by the Camera and Imaging Products Association (CIPA): 23 ±3 °C (73.4 ±5.4 °F).
- Nikon reserves the right to change the specifications of the hardware and software described in this manual at any time and without prior notice. Nikon will not be held liable for damages that may result from any mistakes that this manual may contain.





<b>MH-25 battery charger</b>	
<b>Rated input (in North America)</b>	AC 120 V, 60 Hz, 0.2 A
<b>Rated input (in other regions)</b>	AC 100–240 V, 50/60 Hz, 0.23–0.12 A
<b>Rated output</b>	DC 8.4 V/1.2 A
<b>Supported batteries</b>	Nikon EN-EL15 rechargeable Li-ion batteries
<b>Charging time</b>	Approx. 2 hours and 35 minutes at an ambient temperature of 25 °C (77 °F) when no charge remains
<b>Operating temperature</b>	0 °C–40 °C (+32 °F–104 °F)
<b>Dimensions (W × H × D)</b>	Approx. 91.5 × 33.5 × 71 mm (3.6 × 1.3 × 2.8 in.), excluding projections
<b>Length of power cable</b>	Approx. 1.8 m/6 ft (U.S.A. and Canada) or 1.5 m/4.9 ft (other countries)
<b>Weight</b>	Approx. 110 g (3.9 oz), excluding power cable and AC wall adapter
<b>EN-EL15 rechargeable Li-ion battery</b>	
<b>Type</b>	Rechargeable lithium-ion battery
<b>Rated capacity</b>	7.0 V/1,900 mAh
<b>Operating temperature</b>	0 °C–40 °C (+32 °F–104 °F)
<b>Dimensions (W × H × D)</b>	Approx. 40 × 56 × 20.5 mm (1.6 × 2.2 × 0.8 in.)
<b>Weight</b>	Approx. 88 g (3.1 oz), excluding terminal cover

Nikon reserves the right to change the specifications of the hardware and software described in this manual at any time and without prior notice. Nikon will not be held liable for damages that may result from any mistakes that this manual may contain.



ViewNX 2		
	Windows	Mac OS
<b>CPU</b>	<ul style="list-style-type: none"> <li>• <b>Photos:</b> Intel Celeron, Pentium 4, Core series, 1.6 GHz or better</li> <li>• <b>Movies (playback):</b> 3.0 GHz or better Pentium D; Intel Core i5 or better recommended when viewing movies with a frame size of 1280 × 720 or more at a frame rate of 30 fps or above or movies with a frame size of 1920 × 1080 or more</li> <li>• <b>Movies (editing):</b> Intel Core i5 or better</li> </ul>	<ul style="list-style-type: none"> <li>• <b>Photos:</b> Intel Core or Xeon series</li> <li>• <b>Movies (playback):</b> Core Duo 2 GHz or better; Intel Core i5 or better recommended when viewing movies with a frame size of 1280 × 720 or more at a frame rate of 30 fps or above or movies with a frame size of 1920 × 1080 or more</li> <li>• <b>Movies (editing):</b> Intel Core i5 or better</li> </ul>
<b>OS</b>	Pre-installed versions of Windows 8, Windows 7, Windows Vista, and Windows XP; note that 64-bit versions of Windows XP are not supported	OS X 10.8 or 10.7, Mac OS X 10.6
<b>Memory (RAM)</b>	<ul style="list-style-type: none"> <li>• <b>32-bit Windows 8, Windows 7, or Windows Vista:</b> 1 GB or more (2 GB or more recommended)</li> <li>• <b>64-bit Windows 8, Windows 7, or Windows Vista:</b> 2 GB or more (4 GB or more recommended)</li> <li>• <b>Windows XP:</b> 512 MB or more (2 GB or more recommended)</li> </ul>	<ul style="list-style-type: none"> <li>• <b>OS X 10.8, 10.7:</b> 2 GB or more (4 GB or more recommended)</li> <li>• <b>Mac OS X 10.6:</b> 1 GB or more (4 GB or more recommended)</li> </ul>
<b>Hard-disk space</b>	A minimum of 1 GB available on the startup disk (3 GB or more recommended)	
<b>Graphics</b>	<b>Resolution:</b> 1024 × 768 pixels (XGA) or more (1280 × 1024 pixels or more recommended) <b>Color:</b> 24-bit color (True Color) or more	<b>Resolution:</b> 1024 × 768 pixels (XGA) or more (1280 × 1024 pixels or more recommended) <b>Color:</b> 24-bit color (millions of colors) or more



## ■ ■ **Supported Standards**

- **DCF Version 2.0:** The Design Rule for Camera File Systems (DCF) is a standard widely used in the digital camera industry to ensure compatibility among different makes of camera.
- **DPOF:** Digital Print Order Format (DPOF) is an industry-wide standard that allows pictures to be printed from print orders stored on the memory card.
- **Exif version 2.3:** The camera supports Exif (Exchangeable Image File Format for Digital Still Cameras) version 2.3, a standard in which information stored with photographs is used for optimal color reproduction when the images are output on Exif-compliant printers.
- **PictBridge:** A standard developed through cooperation with the digital camera and printer industries, allowing photographs to be output directly to a printer without first transferring them to a computer.
- **HDMI:** High-Definition Multimedia Interface is a standard for multimedia interfaces used in consumer electronics and AV devices capable of transmitting audiovisual data and control signals to HDMI-compliant devices via a single cable connection.

### **Trademark Information**

Mac OS and OS X are registered trademarks of Apple Inc. in the United States and/or other countries. Microsoft, Windows, and Windows Vista are either registered trademarks, or trademarks of Microsoft Corporation in the United States and/or other countries. PictBridge is a trademark. The SD, SDHC, and SDXC logos are trademarks of the SD-3C, LLC. HDMI, the HDMI logo and High-Definition Multimedia Interface are trademarks or registered trademarks of HDMI Licensing LLC.

## **HDMI**

All other trade names mentioned in this manual or the other documentation provided with your Nikon product are trademarks or registered trademarks of their respective holders.



# Approved Memory Cards

The following SD memory cards have been tested and approved for use in the camera. Cards with class 6 or faster write speeds are recommended for movie recording. Recording may end unexpectedly when cards with slower write speeds are used.

	SD cards	SDHC cards <sup>2</sup>	SDXC cards <sup>3</sup>
<b>SanDisk</b>	2 GB <sup>1</sup>	4 GB, 8 GB, 16 GB, 32 GB	64 GB
<b>Toshiba</b>			
<b>Panasonic</b>		4 GB, 6 GB, 8 GB, 12 GB, 16 GB, 24 GB, 32 GB	48 GB, 64 GB
<b>Lexar Media</b>		4 GB, 8 GB, 16 GB	
<b>Platinum II</b>		4 GB, 8 GB, 16 GB, 32 GB	—
<b>Professional</b>			
<b>Full-HD Video</b>	—	4 GB, 8 GB, 16 GB	

1 Check that any card readers or other devices with which the card will be used support 2 GB cards.

2 Check that any card readers or other devices with which the card will be used are SDHC-compliant. The camera supports UHS-1.

3 Check that any card readers or other devices with which the card will be used are SDXC-compliant. The camera supports UHS-1.



Other cards have not been tested. For more details on the above cards, please contact the manufacturer.



# Memory Card Capacity

The following table shows the approximate number of pictures that can be stored on an 8 GB SanDisk Extreme Pro SDHC UHS-I card at different image quality (□ 93), image size (□ 95), and image area settings (□ 89).

## ■ FX (36×24) Image Area \*

Image quality	Image size	File size <sup>1</sup>	No. of images <sup>1</sup>	Buffer capacity <sup>2</sup>
NEF (RAW), Lossless compressed, 12-bit	—	23.4 MB	190	21
NEF (RAW), Lossless compressed, 14-bit	—	29.2 MB	147	14
NEF (RAW), Compressed, 12-bit	—	20.7 MB	258	26
NEF (RAW), Compressed, 14-bit	—	25.4 MB	215	14
JPEG fine <sup>3</sup>	Large	12.4 MB	506	51
	Medium	7.4 MB	853	100
	Small	3.8 MB	1600	100
JPEG normal <sup>3</sup>	Large	6.2 MB	1000	90
	Medium	3.7 MB	1600	100
	Small	1.9 MB	3200	100
JPEG basic <sup>3</sup>	Large	3.2 MB	1900	100
	Medium	1.9 MB	3200	100
	Small	1.0 MB	6300	100

\* Includes images taken with non-DX lenses when **On** is selected for **Auto DX crop**.



## ■ ■ DX (24×16) Image Area \*

Image quality	Image size	File size <sup>1</sup>	No. of images <sup>1</sup>	Buffer capacity <sup>2</sup>
NEF (RAW), Lossless compressed, 12-bit	—	10.9 MB	426	55
NEF (RAW), Lossless compressed, 14-bit	—	13.4 MB	332	34
NEF (RAW), Compressed, 12-bit	—	9.7 MB	571	73
NEF (RAW), Compressed, 14-bit	—	11.7 MB	480	54
JPEG fine <sup>3</sup>	Large	5.9 MB	1000	100
	Medium	3.7 MB	1700	100
	Small	2.2 MB	2900	100
JPEG normal <sup>3</sup>	Large	3.0 MB	2100	100
	Medium	1.9 MB	3300	100
	Small	1.1 MB	5700	100
JPEG basic <sup>3</sup>	Large	1.5 MB	4100	100
	Medium	1.0 MB	6300	100
	Small	0.6 MB	10000	100

\* Includes images taken with DX lenses when **On** is selected for **Auto DX crop**.

- 1 All figures are approximate. File size varies with scene recorded.
- 2 Maximum number of exposures that can be stored in memory buffer at ISO 100. Drops if **Optimal quality** is selected for **JPEG compression** (☐ 94), ISO sensitivity is set to Hi 0.3 or higher, or long exposure noise reduction or auto distortion control is on.
- 3 Figures assume **JPEG compression** is set to **Size priority**. Selecting **Optimal quality** increases the file size of JPEG images; number of images and buffer capacity drop accordingly.

### **d6—Max. Continuous Release** (☐ 230)

The maximum number of photographs that can be taken in a single burst can be set to any amount between 1 and 100.

# Battery Life

The number of shots that can be taken with fully-charged batteries varies with the condition of the battery, temperature, and how the camera is used. In the case of AA batteries, capacity also varies with make and storage conditions; some batteries can not be used. Sample figures for the camera and optional MB-D14 multi-power battery pack are given below.

- **CIPA standard**<sup>1</sup>

- **One EN-EL15 battery (camera):** Approximately 900 shots

- **One EN-EL15 battery (MB-D14):** Approximately 900 shots

- **Six AA alkaline batteries (MB-D14):** Approximately 650 shots

- **Nikon standard**<sup>2</sup>

- **One EN-EL15 battery (camera):** Approximately 3500 shots

- **One EN-EL15 battery (MB-D14):** Approximately 3500 shots

- **Six AA alkaline batteries (MB-D14):** Approximately 1450 shots

- **Movies**<sup>3</sup>

- **One EN-EL15 battery (camera):** Approximately 110 minutes of HD footage

- **One EN-EL15 battery (MB-D14):** Approximately 110 minutes of HD footage

- **Six AA alkaline batteries (MB-D14):** Approximately 58 minutes of HD footage

1 Measured at 23 °C/73.4 °F (±2 °C/3.6 °F) with an AF-S NIKKOR 24–85mm f/3.5–4.5G ED VR lens under the following test conditions: lens cycled from infinity to minimum range and one photograph taken at default settings once every 30 s; flash fired once every other shot. Live view not used.

2 Measured at 20 °C/68 °F with an AF-S NIKKOR 24–85mm f/3.5–4.5G ED VR lens under the following test conditions: image quality set to JPEG basic, image size set to **M** (medium), shutter speed  $1/250$  s, shutter-release button pressed halfway for three seconds and focus cycled from infinity to minimum range three times; six shots are then taken in succession and monitor turned on for five seconds and then turned off; cycle repeated once standby timer expires.

3 Measured at 23 °C/73.4 °F (±3 °C/5.4 °F) with the camera at default settings and an AF-S NIKKOR 24–85mm f/3.5–4.5G ED VR lens under conditions specified by the Camera and Imaging Products Association (CIPA). Individual movies can be up to 20 minutes (1080/30p and 1080/25p) in length or 4 GB in size; recording may end before these limits are reached if the camera temperature rises.

The following can reduce battery life:

- Using the monitor
- Keeping the shutter-release button pressed halfway
- Repeated autofocus operations
- Taking NEF (RAW) photographs
- Slow shutter speeds
- Using a GP-1/GP-1A GPS unit
- Using an Eye-Fi card
- Using a WU-1b wireless mobile adapter
- Using VR (vibration reduction) mode with VR lenses

To ensure that you get the most from rechargeable Nikon EN-EL15 batteries:

- Keep the battery contacts clean. Soiled contacts can reduce battery performance.
- Use batteries immediately after charging. Batteries will lose their charge if left unused.



# Index

## Symbols

(Auto mode)..... 35, 36  
 (Auto (flash off) mode) .... 35, 36  
**SCENE** (Scene)..... 40  
 (Portrait)..... 41  
 (Landscape)..... 41  
 (Child)..... 41  
 (Sports)..... 41  
 (Close up)..... 42  
 (Night portrait)..... 42  
 (Night landscape)..... 42  
 (Party/indoor)..... 42  
 (Beach/snow)..... 43  
 (Sunset)..... 43  
 (Dusk/dawn)..... 43  
 (Pet portrait)..... 43  
 (Candlelight)..... 44  
 (Blossom)..... 44  
 (Autumn colors)..... 44  
 (Food)..... 44  
 (Silhouette)..... 45  
 (High key)..... 45  
 (Low key)..... 45  
**P** (Programmed auto)..... 75  
**S** (Shutter-priority auto)..... 76  
**A** (Aperture-priority auto)..... 77  
**M** (Manual)..... 78  
**U1/U2**..... 81  
**S** (Single frame)..... 6, 83  
**CL** (Continuous low speed)..... 6, 83, 229  
**CH** (Continuous high speed)..... 6, 83  
**Q** (Quiet shutter-release)..... 6, 83  
**QC** (QC shutter-release)..... 6, 83  
 (Self-timer)..... 6, 83, 85  
 (Remote control)..... 6, 83, 85  
**MUP** (Mirror up)..... 6, 83, 88  
 (Face-priority AF)..... 52  
 (Wide-area AF)..... 52  
 (Normal-area AF)..... 52  
 (Subject-tracking AF)..... 52  
 (Matrix)..... 109  
 (Center-weighted)..... 109, 226  
 (Spot)..... 109  
**AUTO** (Auto flash)..... 144, 145  
 (Red-eye reduction).... 144, 145  
**SLOW** (Slow sync)..... 144, 145  
**REAR** (Rear-curtain sync) .. 144, 145  
 (Exposure compensation) .... 112  
 (Flash compensation)..... 148  
 (Flexible program)..... 75  
 (Live view) button..... 49, 57  
 (Info) button..... 9, 11

switch..... 2  
**WB** (White balance)..... 115  
**PRE** (Preset manual)..... 115, 121  
**BKT** (Bracketing)..... 153, 178  
 (Help)..... 18  
 (Focus indicator)..... 38, 102, 103  
 (Memory buffer)..... 38, 84  
 (Flash-ready indicator)..... 39

## Numerics

12-bit..... 94  
14-bit..... 94  
2,016-pixel RGB sensor..... 146, 327  
3D-tracking..... 99, 100

## A

AC adapter..... 297, 299  
Accessories..... 297  
Accessory shoe..... 292  
Accessory terminal..... 298  
Active D-Lighting..... 137, 158  
Add items (My Menu)..... 280  
ADL bracketing..... 158, 241  
Adobe RGB..... 217  
AE & flash (Auto bracketing set)..... 153, 241  
AE lock..... 110  
AE only (Auto bracketing set) . 153, 241  
**AE-L/AF-L** button.. 102, 110, 244, 248  
AF..... 51–52, 97–102  
AF area brackets..... 8, 33  
AF fine-tune..... 259  
AF point illumination..... 222  
AF-A..... 97  
AF-area mode..... 52, 99  
AF-assist..... 223, 290, 296  
AF-C..... 97, 221  
AF-F..... 51  
AF-mode button..... 51, 52, 98, 100  
AF-S..... 51, 97, 221  
After delete..... 212  
**A-M** mode switch..... 26  
Ambient brightness sensor... 4, 53, 250  
Angle of view..... 291  
Aperture..... 74, 77–78  
Aperture-priority auto..... 77  
Aspect ratio..... 265  
Assign AE-L/AF-L button . 244, 248  
Assign Fn button..... 242, 247  
Assign MB-D14 button..... 247  
Assign preview button..... 244, 248  
Assign shutter button..... 248

Attaching the lens..... 25  
Auto (White balance)..... 115  
Auto bracketing..... 153, 241  
Auto bracketing set..... 241  
Auto distortion control..... 217  
Auto DX crop..... 89, 91  
Auto flash..... 145  
Auto FP high-speed sync. 234, 235  
Auto image rotation..... 254  
Auto ISO sensitivity control..... 107  
Auto-area AF..... 99, 100  
Autoexposure lock..... 110  
Autofocus..... 51–52, 97–102  
Autofocus mode..... 51, 97  
Auto-servo AF..... 97  
Available settings..... 309

## B

Backlight..... 2, 231  
Backup (Role played by card in Slot 2)..... 96  
Battery..... 21, 23, 35, 255, 331  
Battery info..... 255  
Battery life..... 337  
Battery order..... 233  
Battery pack..... 232, 233, 247, 255, 297  
Beep..... 228  
Bit rate..... 65  
Black-and-white (Monochrome).... 266  
Blue intensifier (Filter effects) .. 267  
Body cap..... 3, 25, 298  
Border (PictBridge)..... 198  
Bracketing..... 153, 241  
Bracketing order..... 241  
Built-in AF-assist illuminator..... 223  
Built-in flash..... 39, 143, 288  
Bulb..... 78, 79  
Burst..... 162, 230, 242

## C

Calendar playback..... 186  
Camera Control Pro 2..... 298  
Camera controls..... 92  
Capture NX 2..... 94, 251, 253, 298  
CEC..... 205  
Center-weighted..... 109, 226  
Charging the battery..... 21–22  
Choose color temp. (White balance)..... 115, 120  
Choose image area..... 90, 91  
Choose start/end point..... 69  
CL mode shooting speed..... 229



Clean image sensor ..... 301  
 Clock ..... 27, 253  
 Clock battery ..... 28  
 Cloudy (White balance) ..... 115  
 CLS ..... 293  
 Color balance ..... 268  
 Color outline ..... 275  
 Color sketch ..... 275  
 Color space ..... 217  
 Color temperature ... 115, 116, 120  
 Commander mode ..... 237  
 Compatible lenses ..... 285  
 Compressed (Type) ..... 94  
 Computer ..... 193  
 Connector for external  
 microphone ..... 2  
 Continuous high speed ..... 6, 83  
 Continuous low speed ... 6, 83, 229  
 Continuous release mode ..... 6, 83  
 Continuous-servo AF ..... 97, 221  
 Control panel ..... 7  
 Copy image(s) ..... 209  
 Copyright ..... 182, 256  
 CPU contacts ..... 287  
 CPU lens ..... 26, 285  
 Creative Lighting System ..... 293  
 Cross screen (Filter effects) ..... 267  
 Custom Settings ..... 219  
 Customize command dials ..... 245  
 Cyanotype (Monochrome) ..... 266

## D

Date and time ..... 27, 253  
 Date format ..... 27, 253  
 Daylight saving time ..... 27, 253  
 DCF ..... 333  
 Default settings 151, 214, 221, 312  
 Delayed remote (Remote control  
 mode) ..... 85  
 Delete ..... 47, 189  
 Delete all images ..... 190  
 Delete current image ..... 47, 189  
 Delete selected images ..... 190  
 Depth-of-field ..... 77  
 Depth-of-field preview button .60,  
 77, 241, 244, 248  
 Destination (Movie settings) ..... 65  
 Device control (HDMI) ..... 205  
 Digital Print Order Format ..... 199,  
 202, 333  
 Diopter adjustment control ..... 33,  
 297  
 Direct sunlight (White balance) .....  
 115  
 Distortion control ..... 274  
 D-Lighting ..... 264

DPOF ..... 199, 202, 333  
 DPOF print order ..... 202  
 DX (24 × 16) 1.5 × ..... 63, 90  
 DX format ..... 89, 90  
 DX-based movie format ..... 63  
 Dynamic-area AF ..... 99, 100

## E

Easy exposure compensation .. 225  
 Edit movie ..... 69  
 Electronic rangefinder ..... 103  
 EV steps for exposure cntrl ..... 224  
 Exif ..... 217, 333  
 Exposure ..... 74, 109–113  
 Exposure bracketing ..... 153, 241  
 Exposure comp. for flash ..... 240  
 Exposure compensation ..... 112  
 Exposure delay mode ..... 231  
 Exposure differential ..... 140  
 Exposure indicator ..... 78  
 Exposure lock ..... 110  
 Exposure meters ..... 39, 227  
 Exposure program ..... 315  
 External microphone ..... 61, 65  
 Eye-Fi upload ..... 260

## F

Face-priority AF ..... 52  
 File naming ..... 216  
 File number sequence ..... 230  
 Filter effects ..... 132, 133, 267  
 Fine-tune optimal exposure ..... 226  
 Fine-tuning white balance ..... 117  
 Firmware version ..... 260  
 Fisheye ..... 274  
 Flash ..... 39, 143, 144, 148, 149, 292  
 Flash (White balance) ..... 115  
 Flash bracketing ..... 153, 241  
 Flash cntrl for built-in flash ..... 236  
 Flash compensation ..... 148  
 Flash mode ..... 144, 145  
 Flash only (Auto bracketing set) .....  
 153, 241  
 Flash range ..... 147  
 Flash ready indicator .. 39, 149, 296  
 Flash shutter speed ..... 146, 235  
 Flash sync speed ..... 234, 235, 327  
 Flash warning ..... 231  
 Flexible program ..... 75  
 Flicker reduction ..... 252  
 Fluorescent (White balance) ..... 115  
 Fn button ..... 92, 149, 174, 242, 247  
 f-number ..... 73, 77, 288  
 Focal length ..... 173, 291  
 Focal length scale ..... 25  
 Focal length scale index ..... 25

Focal plane mark ..... 103  
 Focus indicator ..... 38, 102, 103  
 Focus lock ..... 102  
 Focus mode ..... 51, 97  
 Focus mode switch ..... 25, 26, 103  
 Focus point ..... 38, 52, 99, 101, 103,  
 222, 223  
 Focus point wrap-around ..... 222  
 Focus tracking ..... 97, 222  
 Focus tracking with lock-on ..... 222  
 Focusing screen ..... 327  
 Focus-mode selector ..... 51, 97  
 Format memory card ..... 31, 250  
 Frame interval (Slide show) ..... 213  
 Frame size/frame rate ..... 65  
 Framing guides ..... 55, 62  
 Front-curtain sync ..... 145  
 Full-frame playback ..... 177  
 Full-time servo AF ..... 51  
 FV lock ..... 149  
 FX (36 × 24) 1.0 × ..... 90  
 FX format ..... 89, 90  
 FX-based movie format ..... 63

## G

GPS ..... 175, 183  
 GPS data ..... 183  
 Green intensifier (Filter effects) .....  
 267

## H

H.264 ..... 329  
 HDMI ..... 56, 64, 204, 333  
 HDMI mini-pin connector ..... 2  
 HDMI-CEC ..... 205  
 Headphones ..... 61, 62  
 Help ..... 18  
 Hi (Sensitivity) ..... 106  
 Hide image ..... 208  
 High definition ..... 204, 333  
 High Dynamic Range (HDR) ..... 139  
 High ISO NR ..... 218  
 Highlights ..... 180, 209  
 Histogram ..... 180, 181, 209

## I

Image area ..... 26, 63, 89, 91, 95  
 Image comment ..... 253  
 Image Dust Off ref photo ..... 251  
 Image overlay ..... 269  
 Image quality ..... 93  
 Image review ..... 171, 177, 212  
 Image size ..... 95  
 Image type (Slide show) ..... 213  
 Incandescent (White balance) 115  
 Index marking ..... 60, 68, 247



Index print ..... 199  
 In-focus indicator ..... 38, 102, 103  
 Information ..... 9, 179  
 Information display ..... 9, 231  
 Interval timer shooting ..... 164  
 ISO display and adjustment ..... 229  
 ISO sensitivity ..... 105, 107  
 ISO sensitivity settings ..... 107  
 ISO sensitivity step value ..... 224  
 i-TTL ..... 143, 146, 237

## J

JPEG ..... 93  
 JPEG basic ..... 93  
 JPEG compression ..... 94  
 JPEG fine ..... 93  
 JPEG normal ..... 93

## L

L (large) ..... 63, 95  
 Landscape (Set Picture Control) ....  
 129  
 Language ..... 27, 253  
 LCD illumination ..... 2, 231  
 Lens ..... 25–26, 172, 259, 285  
 Lens cap ..... 25  
 Lens focus ring ..... 25, 55, 103  
 Lens mount ..... 3, 26, 103  
 Live view ..... 49–56, 57–64  
 Live view photography ..... 49  
 Live view selector ..... 49, 57  
 Lo (Sensitivity) ..... 106  
 Lock mirror up for cleaning ..... 303  
 Long exposure NR ..... 218  
 Lossless compressed (Type) ..... 94

## M

M (medium) ..... 63, 95  
 Main command dial ..... 12  
 Manage Picture Control ..... 134  
 Manual ..... 78, 103  
 Manual (Flash cntl for built-in  
 flash) ..... 236  
 Manual focus ..... 55, 103  
 Matrix ..... 109  
 Max. continuous release ..... 230  
 Maximum aperture .. 103, 147, 296  
 Maximum sensitivity ..... 107  
 MB-D14 ..... 232, 233, 247, 255, 297  
 MB-D14 battery type ..... 232  
 Memory buffer ..... 38, 84  
 Memory card 29, 31, 250, 334, 335  
 Memory card capacity ..... 335  
 Metering ..... 109  
 Microphone ..... 3, 61, 62, 65  
 Miniature effect ..... 276

Minimum aperture ..... 26, 73  
 Minimum shutter speed ..... 107  
 Mired ..... 119  
 Mirror ..... 85, 88, 303  
 Mirror up ..... 6, 83, 88  
 Mode dial ..... 5  
 Mode dial lock release ..... 5  
 Modeling flash ..... 241  
 Monitor ..... 46, 49, 177, 250  
 Monitor brightness ..... 250  
 Monitor cover ..... 17  
 Monitor off delay ..... 228  
 Monitor pre-flash ..... 146, 149  
 Monochrome ..... 129, 266  
 Movie live view ..... 57, 247–248  
 Movie quality (Movie settings) .. 65  
 Movie settings ..... 65  
 Movie-record button ..... 58  
 Movies ..... 57, 247–248  
 Multiple exposure ..... 160  
 My Menu ..... 280

## N

NEF (RAW) ..... 93, 94, 216, 271  
 NEF (RAW) bit depth ..... 94  
 NEF (RAW) processing ..... 271  
 NEF (RAW) recording ..... 94  
 Neutral (Set Picture Control) .... 129  
 Nikon Transfer 2 ..... 193, 194  
 Non-CPU lens ..... 172, 285, 288  
 Non-CPU lens data ..... 172  
 Normal-area AF ..... 52  
 Number of focus points ..... 223  
 Number of shots ..... 337

## O

OK button (shooting mode) .... 241  
 Optimal quality (JPEG  
 compression) ..... 94  
 Optional flash ..... 237, 292  
 Output resolution (HDMI) ..... 205  
 Overflow (Role played by card in  
 Slot 2) ..... 96  
 Overview data ..... 184

## P

Page size (PictBridge) ..... 198  
 Perspective control ..... 275  
 Photo information ..... 179, 209  
 PictBridge ..... 196, 333  
 Picture Controls ..... 129, 131  
 Picture size ..... 291  
 Pitching ..... 258  
 Playback ..... 46, 177  
 Playback display options ..... 209  
 Playback folder ..... 207

Playback information ..... 179, 209  
 Playback menu ..... 207  
 Playback slot and folder ..... 178  
 Playback zoom ..... 187  
 Portrait (Set Picture Control) .... 129  
 Power connector ..... 297, 299  
 Power switch ..... 1  
 Predictive focus tracking ..... 97  
 Preset manual (White balance) .....  
 115, 121  
 Press the shutter-release button  
 all the way down ..... 38, 39  
 Press the shutter-release button  
 half-way ..... 38, 39  
 Preview button ..... 77, 244, 248  
 Print (DPOF) ..... 199  
 Print select ..... 199  
 Printing ..... 196  
 Programmed auto ..... 75  
 Protecting photographs ..... 188

## Q

Qc shutter-release ..... 6, 83  
 Quick retouch ..... 273  
 Quick-response remote (Remote  
 control mode) ..... 85  
 Quiet shutter-release ..... 6, 83

## R

Rank items (My Menu) ..... 282  
 RAW Slot 1 - JPEG Slot 2 (Role  
 played by card in Slot 2) ..... 96  
 Rear-curtain sync ..... 145  
 Recent settings ..... 283  
 Red intensifier (Filter effects) .. 267  
 Red-eye correction ..... 264  
 Red-eye reduction ..... 144, 145  
 Release button to use dial ..... 246  
 Release mode ..... 6, 83  
 Release mode dial ..... 6, 83  
 Release mode dial lock release ...6,  
 83  
 Remote control ..... 6, 83, 85, 298  
 Remote control mode ..... 85  
 Remote cord ..... 79, 88, 298  
 Remote mirror-up (Remote  
 control mode) ..... 85  
 Remote on duration ..... 228  
 Remove items (My Menu) ..... 281  
 Removing the lens from the  
 camera ..... 26  
 Repeating flash ..... 236  
 Reset ..... 151, 214, 221  
 Reset custom settings ..... 221  
 Reset shooting menu ..... 214  
 Reset user settings ..... 82

Resize.....272  
 Restoring default settings..... 151,  
 214, 221, 312  
 Retouch menu .....261  
 Reverse indicators.....246  
 RGB.....180, 217  
 Role played by card in Slot 2.....96  
 Rotate tall.....212  
**S**  
**S** (small).....63, 95  
 Save selected frame.....69, 72  
 Save user settings.....81  
 Save/load settings .....257  
 Saving camera settings.....257  
 Scene mode.....40  
 Screen tips.....229  
 SD memory card.....29, 31, 96, 334,  
 335  
 Select date.....191, 199, 208  
 Selective color.....277  
 Self-timer .....6, 83, 85, 227  
 Sensitivity .....105, 107  
 Sepia (Monochrome).....266  
 Set Picture Control.....129  
 Setup menu .....249  
 Shade (White balance).....115  
 Shooting data.....182  
 Shooting menu.....214  
 Shutter speed.....76, 78  
 Shutter-priority auto.....76  
 Shutter-release button 38, 39, 102,  
 110, 226, 248  
 Shutter-release button AE-L ....226  
 Side-by-side comparison .....279  
 Single frame.....6, 83  
 Single-point AF.....99, 100  
 Single-servo AF.....51, 97, 221  
 Size .....63, 95  
 Size priority (JPEG compression)....  
 94  
 Skylight (Filter effects).....267  
 Slide show .....213  
 Slot .....30, 96, 178  
 Slot empty release lock.....246  
 Slow sync .....144, 145  
 Smoothing.....141  
 Soft (Filter effects).....267  
 Speaker .....3, 4  
 Speedlight .....292  
 Spot.....109  
 sRGB.....217  
 Standard (Set Picture Control) 129  
 Standard i-TTL flash for digital SLR  
 146  
 Standby timer.....39, 175, 227

Start printing (PictBridge) 198, 201  
 Storage folder.....215  
 Straighten .....274  
 Sub-command dial.....12  
 Subject-tracking AF.....52

## T

Television .....204  
 Thumbnail playback .....185  
 Time .....253  
 Time stamp (PictBridge).....198  
 Time zone .....27, 253  
 Time zone and date.....27, 253  
 Time-lapse photography .....168  
 Timer.....85, 164  
 Toning .....132, 133  
 Trim .....265  
 Trimming movies .....69  
 Tripod.....3  
 Two-button reset .....151  
 Type D lens .....285, 287  
 Type E lens.....285, 287  
 Type G lens .....285, 287

## U

USB.....194, 196  
 USB cable .....194, 196  
 Use GPS to set camera clock....175  
 User settings .....81  
 UTC.....27, 175, 183

## V

Vibration reduction mode switch..  
 25  
 Viewfinder .....8, 33, 297, 326  
 Viewfinder eyepiece .....86  
 Viewfinder eyepiece cap .....86  
 Viewfinder focus.....33, 297  
 Viewfinder grid display .....229  
 ViewNX 2.....193, 217  
 Vignette control.....218  
 Virtual horizon .....55, 62, 243, 258  
 Vivid (Set Picture Control).....129  
 Volume.....67

## W

Warm filter (Filter effects).....267  
 WB .....115, 156  
 WB bracketing (Auto bracketing  
 set).....156, 241  
 White balance .....115, 156  
 Wide-area AF .....52  
 Wireless mobile adapter.....298



No reproduction in any form of this manual, in whole or in part (except for brief quotation in critical articles or reviews), may be made without written authorization from NIKON CORPORATION.

