

Panasonic[®]

Basic Owner's Manual

Digital Camera/
Lens Kit/Body

Model No. **DMC-G85M**
DMC-G85



LUMIX

Please read these instructions carefully before using this product, and save this manual for future use.

More detailed owner's manual is available in "Owner's Manual for advanced features (PDF format)". To read it, download it from the website. (P73)

Register online at <http://shop.panasonic.com/support> (U.S. customers only)

If you have any questions, visit:
USA : <http://shop.panasonic.com/support>
Canada : www.panasonic.ca/english/support



DVQX1003ZA

F0816HN0



Dear Customer,

Thank you for choosing Panasonic!

You have purchased one of the most sophisticated and reliable products on the market today. Used properly, we're sure it will bring you and your family years of enjoyment. Please take time to fill in the information below. The serial number is on the tag located on the underside of your camera. Be sure to **retain this manual** as your convenient camera information source.

Date of Purchase	Dealer Phone No.
Dealer Purchased From	Model No.
Dealer Address	Serial No.

Please note that the actual controls and components, menu items, etc. of your Digital Camera may look somewhat different from those shown in the illustrations in this Owner's Manual.

Carefully observe copyright laws.

- Recording of pre-recorded tapes or discs or other published or broadcast material for purposes other than your own private use may infringe copyright laws. Even for the purpose of private use, recording of certain material may be restricted.

For the U.S.A. and Canada only



A lithium ion battery that is recyclable powers the product you have purchased. Please call 1-800-8-BATTERY for information on how to recycle this battery.

Information for Your Safety

WARNING:

To reduce the risk of fire, electric shock or product damage,

- Do not expose this unit to rain, moisture, dripping or splashing.
- Use only the recommended accessories.
- Do not remove covers.
- Do not repair this unit by yourself. Refer servicing to qualified service personnel.

The socket outlet shall be installed near the equipment and shall be easily accessible.

■ Product identification marking

Product	Location
Digital Camera	Bottom
Battery charger	Bottom

THE FOLLOWING APPLIES ONLY IN THE U.S.A.

FCC Note:

This equipment has been tested and found to comply with the limits for a Class B digital device, pursuant to Part 15 of the FCC Rules. These limits are designed to provide reasonable protection against harmful interference in a residential installation. This equipment generates, uses, and can radiate radio frequency energy and, if not installed and used in accordance with the instructions, may cause harmful interference to radio communications. However, there is no guarantee that interference will not occur in a particular installation. If this equipment does cause harmful interference to radio or television reception, which can be determined by turning the equipment off and on, the user is encouraged to try to correct the interference by one or more of the following measures:

- Reorient or relocate the receiving antenna.
- Increase the separation between the equipment and receiver.
- Connect the equipment into an outlet on a circuit different from that to which the receiver is connected.
- Consult the dealer or an experienced radio/TV technician for help.

FCC Caution: To assure continued compliance, follow the attached installation instructions and use only shielded interface cables with ferrite core when connecting to computer or peripheral devices.

Any changes or modifications not expressly approved by the party responsible for compliance could void the user's authority to operate this equipment.

This device complies with Part 15 of the FCC Rules. Operation is subject to the following two conditions: (1) This device may not cause harmful interference, and (2) this device must accept any interference received, including interference that may cause undesired operation.

Declaration of Conformity

Trade Name: Panasonic

Model No.: DMC-G85

Responsible Party: Panasonic Corporation of North America

Two Riverfront Plaza, Newark, NJ 07102-5490

Support Contact: <http://shop.panasonic.com/support>



THE FOLLOWING APPLIES ONLY IN THE U.S.A.

Certification and Compliance

See Camera for the certification and compliance mark specific to that device.

- 1 Select **[Wi-Fi]** in the **[Setup]** menu.
- 2 Select **[Wi-Fi Setup]** in the **[Wi-Fi]** menu.
- 3 Press **▲/▼** to select **[Approved Regulations]**, and press **[MENU/SET]**.

Contains FCC ID: VPYLBXN604

This transmitter must not be co-located or operated in conjunction with any other antenna or transmitter.

This equipment complies with FCC radiation exposure limits set forth for an uncontrolled environment and meets the FCC radio frequency (RF) Exposure Guidelines in Supplement C to OET65.

This equipment has very low levels of RF energy that are deemed to comply without testing of specific absorption ratio (SAR).

THE FOLLOWING APPLIES ONLY IN CANADA.

Certification and Compliance

See Camera for the certification and compliance mark specific to that device.

- 1 Select **[Wi-Fi]** in the **[Setup]** menu.
- 2 Select **[Wi-Fi Setup]** in the **[Wi-Fi]** menu.
- 3 Press **▲/▼** to select **[Approved Regulations]**, and press **[MENU/SET]**.

CAN ICES-3(B)/NMB-3(B)

Contains IC : 772C-LBXN604

This device complies with Industry Canada's licence-exempt RSSs. Operation is subject to the following two conditions:

- (1) this device may not cause interference, and
- (2) this device must accept any interference, including interference that may cause undesired operation of the device.

This equipment complies with IC radiation exposure limits set forth for an uncontrolled environment and meets RSS-102 of the IC radio frequency (RF) Exposure rules.

This equipment has very low levels of RF energy that are deemed to comply without testing of specific absorption ratio (SAR).

■ About the battery pack

CAUTION

Battery pack (Lithium ion battery pack)

- Use the specified unit to recharge the battery pack.
- Do not use the battery pack with equipment other than the specified unit.
- Do not get dirt, sand, liquids, or other foreign matter on the terminals.
- Do not touch the plug terminals (+ and -) with metal objects.
- Do not disassemble, remodel, heat or throw into fire.

If any electrolyte should come into contact with your hands or clothes, wash it off thoroughly with water.

If any electrolyte should come into contact with your eyes, never rub the eyes. Rinse eyes thoroughly with water, and then consult a doctor.

CAUTION

- Danger of explosion if battery is incorrectly replaced. Replace only with the type recommended by the manufacturer.
- When disposing of the batteries, please contact your local authorities or dealer and ask for the correct method of disposal.

- Do not heat or expose to flame.
- Do not leave the battery(ies) in a car exposed to direct sunlight for a long period of time with doors and windows closed.

Warning

Risk of fire, explosion and burns. Do not disassemble, heat above 60 °C (140 °F) or incinerate.

■ About the battery charger

CAUTION!

To reduce the risk of fire, electric shock or product damage,

- **Do not install or place this unit in a bookcase, built-in cabinet or in another confined space. Ensure this unit is well ventilated.**

Battery charger

This battery charger operates on AC between 110 V and 240 V.

But

- In the U.S.A. and Canada, the battery charger must be connected to a 120 V AC power supply only.
- When connecting to an AC supply outside of the U.S.A. or Canada, use a plug adaptor to suit the AC outlet configuration.

Cautions for Use

- Do not use any other USB connection cables except the supplied one.
- Use a "High Speed HDMI micro cable" with the HDMI logo.
Cables that do not comply with the HDMI standards will not work.
"High Speed HDMI micro cable" (Type D–Type A plug, up to 2 m (6.6 feet) long)
- Always use a genuine Panasonic shutter remote control (DMW-RSL1: optional).

Keep this unit as far away as possible from electromagnetic equipment (such as microwave ovens, TVs, video games etc.).

- If you use this unit on top of or near a TV, the pictures and/or sound on this unit may be disrupted by electromagnetic wave radiation.
- Do not use this unit near cell phones because doing so may result in noise adversely affecting the pictures and/or sound.
- Recorded data may be damaged, or pictures may be distorted, by strong magnetic fields created by speakers or large motors.
- Electromagnetic wave radiation may adversely affect this unit, disturbing the pictures and/or sound.
- If this unit is adversely affected by electromagnetic equipment and stops functioning properly, turn this unit off and remove the battery or disconnect AC adaptor (DMW-AC10PP: optional). Then reinsert the battery or reconnect AC adaptor and turn this unit on.

Do not use this unit near radio transmitters or high-voltage lines.

- If you record near radio transmitters or high-voltage lines, the recorded pictures and/or sound may be adversely affected.

-
- **Before cleaning the camera, remove the battery or the DC coupler (DMW-DCC8: optional), or disconnect the power plug from the outlet.**
 - **Do not press the monitor with excessive force.**
 - **Do not press the lens with excessive force.**
 - **Do not spray the camera with insecticides or volatile chemicals.**
 - **Do not keep rubber or plastic products in contact with the camera for a long period of time.**
 - **Do not use solvents such as benzine, thinner, alcohol, kitchen detergents, etc., to clean the camera, since it may deteriorate the external case or the coating may peel off.**
 - **Do not leave the camera with the lens facing the sun, as rays of light from the sun may cause it to malfunction.**
 - **Always use the supplied cords and cables.**
 - **Do not extend the cords or the cables.**
 - **During access (image writing, reading and deleting, formatting etc.), do not turn this unit off, remove the battery, card or disconnect the AC adaptor (DMW-AC10PP: optional). Furthermore, do not subject the camera to vibration, impact or static electricity.**
 - **The data on the card may be damaged or lost due to electromagnetic waves, static electricity or breakdown of the camera or the card. We recommend storing important data on a PC etc.**
 - **Do not format the card on your PC or other equipment. Format it on the camera only to ensure proper operation.**
-
- **The battery is not charged when the camera is shipped. Charge the battery before use.**
 - **The battery is a rechargeable lithium ion battery. If the temperature is too high or too low, the operating time of the battery will become shorter.**
 - **The battery becomes warm after using and during and after charging. The camera also becomes warm during use. This is not a malfunction.**
 - **Do not leave any metal items (such as clips) near the contact areas of the power plug or near the batteries.**
 - **Store the battery in a cool and dry place with a relatively stable temperature: [Recommended temperature: 15 °C to 25 °C (59 °F to 77 °F), Recommended humidity: 40%RH to 60%RH]**
 - **Do not store the battery for a long time while fully charged.** When storing the battery for a long period of time, we recommend charging it once a year. Remove the battery from the camera and store it again after it has completely discharged.
-

Contents

Information for Your Safety	2
-----------------------------------	---

Preparation/Basic

Care of the camera	9
Standard Accessories	10
About cards that can be used with this unit	11
Quick Start Guide	12
Names and Functions of Components	18
Basic Operations	21
Setting menu items	24
Calling frequently-used menus instantly (Quick Menu)	25
Assigning frequently used functions to the buttons (function buttons)	25

Recording

Taking Pictures using the Automatic Function (Intelligent Auto Mode)	26
Adjusting Focus Manually	28
Select a Drive Mode	29
Recording 4K Photos	30
Controlling Focus After Recording (Post Focus/Focus Stacking)	32
Taking Pictures While Adjusting a Setting Automatically (Bracket Recording)	35
Image Stabilizer	37
Recording Motion Picture/ 4K Motion Picture	39
Recording Motion Pictures with 4K Live Cropping	41

Playback

Playing Back Pictures	43
Playing Back Motion Pictures	43
Deleting Pictures	44

Menu

Menu list	45
-----------------	----

Wi-Fi

What you can do with the Wi-Fi® function	52
Controlling with a Smartphone/ Tablet	53

Others

Downloading software	57
Monitor Display/Viewfinder Display	58
Troubleshooting	62
Specifications	66
Digital Camera Accessory System	72
Reading the Owner's Manual (PDF format)	73
Limited Warranty (ONLY FOR U.S.A.)	74
Limited Warranty (ONLY FOR CANADA)	77

Care of the camera

Do not subject to strong vibration, shock, or pressure.

- The lens, monitor, or external case may be damaged if used in the following conditions. It may also malfunction or image may not be recorded if you:
 - Drop or hit the camera.
 - Press hard on the lens or the monitor.

■ Splash Proof

Splash Proof is a term used to describe an extra level of protection this camera offers against exposure to a minimal amount of moisture, water or dust. Splash Proof does not guarantee that damage will not occur if this camera is subjected to direct contact with water.

In order to minimize the possibility of damage please be sure the following precautions are taken:

- The Splash Proof feature works in conjunction with the lenses that were specifically designed to support this feature.
- Make sure the built-in flash is closed.
- Make sure that all doors, socket caps and terminal covers are securely closed.
- Make sure that you are in a dry and secure place when changing the battery, lens or memory card. After changing, make sure their protective doors are securely closed.
- If this camera is exposed to water, sand or any other foreign material clean it as soon as possible, taking the necessary precautions that the foreign substance does not get inside the camera.
- Under no circumstances should you touch or place any foreign objects within the camera or in close proximity of the camera's image sensor.

If sand, dust, or liquids such as water droplets adhere to the monitor, wipe them off with a dry soft cloth.

- Not doing so may cause the monitor to respond incorrectly to touch operations.
- If the monitor is closed when such liquids are present, malfunction may result.

If you shake the camera while it is turned off, its sensors may move or a rattling sound may be heard. The sound is caused by the In-Body Image Stabilizer, and this is not a malfunction.

■ About Condensation (When the lens, the viewfinder or monitor is fogged up)

- Condensation occurs when the ambient temperature or humidity changes. Be careful of condensation since it causes lens, viewfinder and monitor stains, fungus and camera malfunction.
- If condensation occurs, turn the camera off and leave it for about 2 hours. The fog will disappear naturally when the temperature of the camera becomes close to the ambient temperature.

About the firmware of your interchangeable lens

For smoother recording, we recommend updating the firmware of the interchangeable lens to the latest version.

- **To view the latest information on the firmware or to download the firmware, visit the support site below:**

<http://panasonic.jp/support/global/cs/dsc/>

(This Site is English only.)

- To check the firmware version of the interchangeable lens, attach it to the camera body and select [Version Disp.] in the [Setup] menu.

Standard Accessories





Check that all the accessories are supplied before using the camera.
Product numbers correct as of September 2016. These may be subject to change.









Digital Camera Body

(This is referred to as **camera body** in this owner's manual.)

1	Interchangeable Lens*1,4
2	Lens Hood
3	Lens Cap*2
4	Lens Rear Cap*2
5	Body Cap*3
6	Battery Pack (Indicated as battery pack or battery in the text) Charge the battery before use.
7	Battery Charger (Indicated as battery charger or charger in the text)
8	USB Connection Cable
9	Shoulder Strap
10	Hot shoe cover
11	Cover for the battery grip connector

DMC-G85M			
1	 H-FS12060	3	 VYF3514
2	 SYA0066	4	 VFC4605

5	 VKF4971	9	 DVPW1001Z
6	 DMW-BLC12PP	10	 SKF0106K
7	 DE-A79B	11	 SKF0145K
8	 K1HY04YY0106		

- *1 This is referred to as **lens** in this owner's manual.
- *2 This is attached to the interchangeable lens at the time of purchase.
- *3 This is attached to the camera body at the time of purchase.
- *4 The interchangeable lens (H-FS12060) included in DMC-G85M is dust- and splash-proof.

• SD Memory Card, SDHC Memory Card and SDXC Memory Card are indicated as **card** in the text.

• **The card is optional.**

• Description in this owner's manual is based on the interchangeable lens (H-FS12060).

(For U.S.A. only)

• If accessories are lost, customers can visit us at <http://shop.panasonic.com/support> for further information about obtaining replacement parts.

(For Canada only)



• If any accessories are lost, customers in Canada should visit our support page at www.panasonic.ca/english/support for further information about obtaining replacement parts.

About cards that can be used with this unit

SD Memory Card (512 MB to 2 GB)	<ul style="list-style-type: none"> This unit is compatible with UHS-I/UHS-II UHS Speed Class 3 standard SDHC/SDXC memory cards. Operation of the cards on the left has been confirmed with Panasonic's cards.
SDHC Memory Card (4 GB to 32 GB)	
SDXC Memory Card (48 GB to 128 GB)	

■ About motion picture/4K photo recording and speed class ratings

Use a card that meets the following ratings of the SD Speed Class or UHS Speed Class.

[Rec Format]	[Rec Quality]	Speed class	Label example
[AVCHD]	All	Class 4 or higher	CLASS  
[MP4]	FHD/HD		
[MP4]	4K	UHS Speed Class 3	

When recording with the 4K Photo/ Post Focus function	UHS Speed Class 3	
--	-------------------	---

- SD Speed Class and UHS Speed Class are the speed standards regarding continuous writing. To check the class, see the labeled side, etc. of the card.
- Please confirm the latest information on the following website.
<http://panasonic.jp/support/global/cs/dsc/>
(This Site is English only.)
- Keep the Memory Card out of reach of children to prevent swallowing.

Quick Start Guide

- Check that the camera is turned off.

1 Attaching the Shoulder Strap

- We recommend attaching the shoulder strap when using the camera to prevent it from dropping.

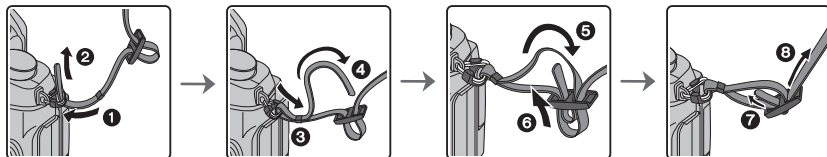

- Perform steps 1 to 8 and then attach the other side of the shoulder strap.
- Use the shoulder strap around your shoulder.
 - Do not wrap the strap around your neck.
 - It may result in injury or accident.
- Do not leave the shoulder strap where an infant can reach it.
 - It may result in an accident by mistakenly wrapping around the neck.

2 Charging the Battery

The battery that can be used with this unit is **DMW-BLC12PP**.

- 1 Attach the battery paying attention to the direction of the battery.
- 2 Connect the charger to the electrical outlet.
 - The [CHARGE] indicator (A) lights up and charging begins.

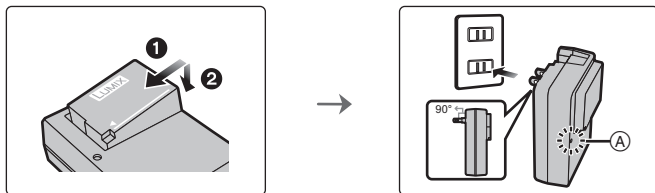

■ About the [CHARGE] indicator

On: Charging.

Off: Charging has completed.
(Disconnect the charger from the electrical socket and detach the battery after charging is completed.)

• **When the [CHARGE] indicator flashes**

- The battery temperature is too high or too low. It is recommended to charge the battery again in an ambient temperature of between 10 °C and 30 °C (50 °F and 86 °F).
- The terminals of the charger or the battery are dirty. In this case, wipe them with a dry cloth.

■ **Charging time**

Charging time

Approx. 140 min

- The indicated charging time is for when the battery has been discharged completely. The charging time may vary depending on how the battery has been used. The charging time for the battery in hot/cold environments or a battery that has not been used for a long time may be longer than normal.

3 Inserting the Battery

- Always use genuine Panasonic batteries (DMW-BLC12PP).
- If you use other batteries, we cannot guarantee the quality of this product.

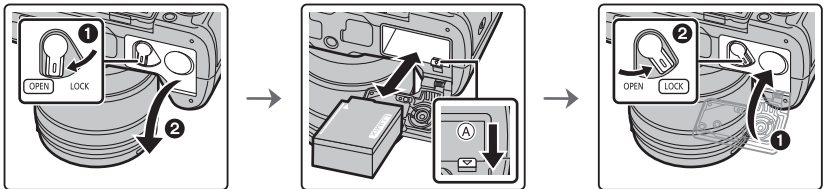

- Being careful about the battery orientation, insert all the way until you hear a locking sound and then check that it is locked by lever (A). Pull the lever (A) in the direction of the arrow to remove the battery.

4 Inserting the Card (Optional)

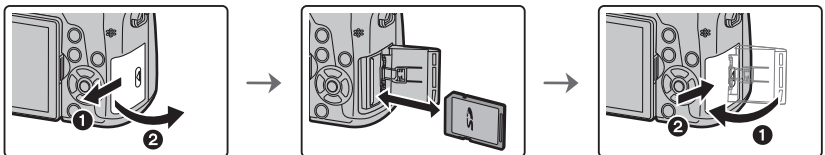

- Push it securely all the way until you hear a "click" while being careful about the direction in which you insert it. To remove the card, push the card until it clicks, then pull the card out upright.

5 Attaching/Removing the Lens

- Change lenses where there is not a lot of dirt or dust.

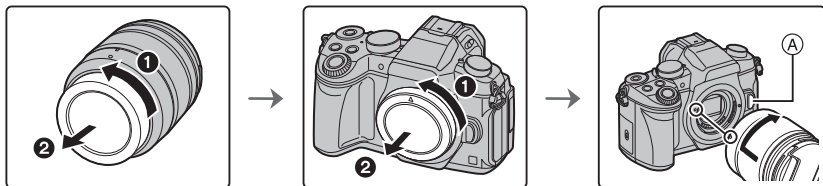

- Do not press the lens release button (A) when you attach a lens.

■ Detaching the lens

- 1 Attach the lens cap.
- 2 While pressing on the lens release button (B), rotate the lens toward the arrow until it stops and then remove.
 - Hold the part around the base of the lens to rotate it.

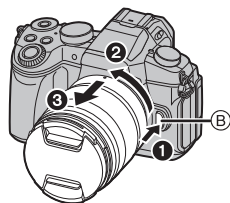

6 Opening the Monitor

At the time when this camera is purchased, the monitor is stowed in the camera body. Bring out the monitor as shown below.

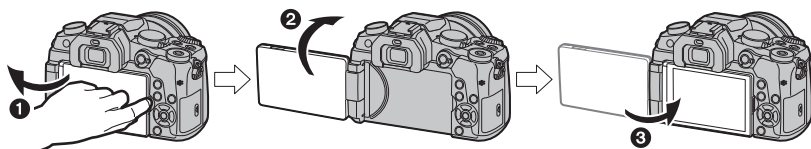

- 1 Open the monitor. (Maximum 180°)
- 2 It can be rotated 180° forward.
- 3 Return the monitor to its original position.

- **Only rotate the monitor after opening it wide enough, and be careful not to use excessive force as it may be damaged.**
- When not using the monitor it is recommended that you close it with the screen facing inward to prevent dirt and scratches.

7 Setting Date/Time (Clock Set)

• The clock is not set when the camera is shipped.

- 1 Turn the camera on.
 - When the camera is turned on, the status indicator **1** lights up green.
- 2 Press [MENU/SET].
- 3 Press ▲/▼ to select the language, and press [MENU/SET].
- 4 Press [MENU/SET].
- 5 Press ◀/▶ to select the items (year, month, day, hour, minute), and press ▲/▼ to set.
- 6 Press [MENU/SET] to set.
- 7 When [The clock setting has been completed.] is displayed, press [MENU/SET].
- 8 When [Please set the home area] is displayed, press [MENU/SET].
- 9 Press ◀/▶ to select the home area, and then press [MENU/SET].

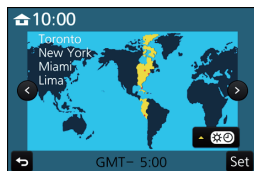
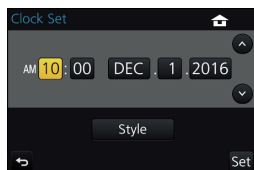
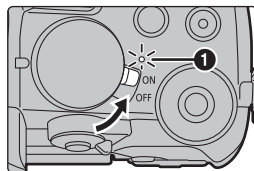

8 Diopter adjustment

Adjust the diopter to suit your vision so that you can see the characters displayed in the viewfinder clearly.

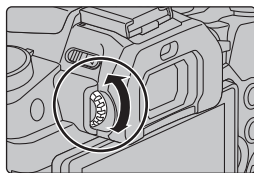

9 Formatting the card (initialization)

Format the card before recording a picture with this unit.

Since data cannot be recovered after formatting, make sure to back up necessary data in advance.

MENU →  **[Setup]** → **[Format]**

10 Set the mode dial to [iA]

Set the mode dial to **[iA]**.

- The settings of the main functions are adjusted automatically.

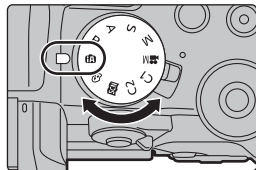

11 Taking pictures

1 Hold the camera gently with both hands, keep your arms still at your side and stand with your feet slightly apart.

- Make sure your footing is stable and there is no danger of colliding with another person or object in the vicinity while taking pictures.
- **Do not cover the flash, AF Assist lamp (A), microphone (B), or speaker (C) with your fingers or other objects.**

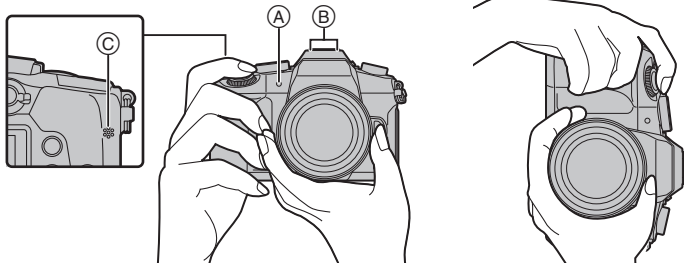

2 Press the shutter button halfway to focus.

- (A) Aperture value
- (B) Shutter speed
- (C) Focus indication

- Aperture value and shutter speed are displayed.
(It will flash in red if the correct exposure is not achieved, except when set to flash.)
- Once the subject is in focus, the focus indication is displayed. (When the subject is not in focus, the indication flashes.)

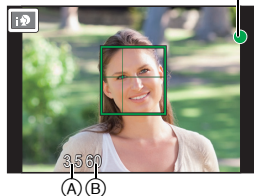
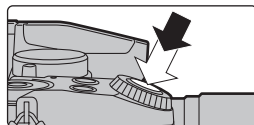
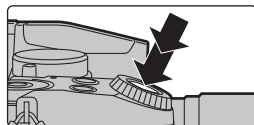
**3 Press the shutter button fully (push it in further), and take the picture.**

- Be careful not to move the camera when you press the shutter button.
- Pictures cannot be taken until focus is achieved when [Focus/Release Priority] is set to [FOCUS].

■ Free angle shooting

The monitor can be rotated to suit your needs. This is convenient as it allows you to take pictures from various angles by adjusting the monitor.

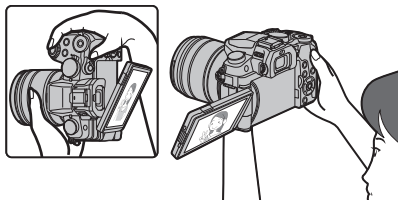
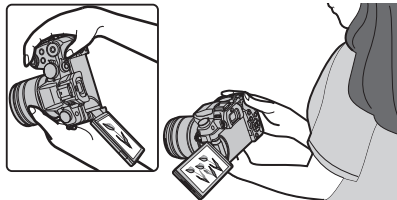
Taking pictures at a high angle**Taking pictures at a low angle****12 Check the picture you have taken**

- The [Auto Review] function displays the picture you have just taken.
- To display the picture in Playback Mode, press [▶].



Names and Functions of Components

■ Camera body

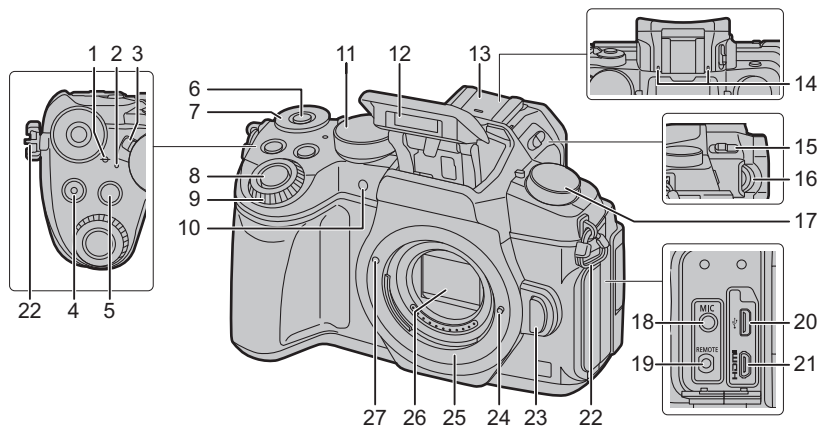

1	Focus distance reference mark	14	Stereo microphone • Be careful not to cover the microphone with your finger. Doing so may make sound difficult to record.
2	Status indicator (P15)/ Wi-Fi® connection lamp (P52)	15	Flash open lever • The flash opens, and recording with the flash becomes possible.
3	Camera ON/OFF switch (P15)	16	Diopter adjustment dial (P15)
4	Motion picture button (P39)	17	Drive mode dial (P29)
5	[] (Exposure Compensation) button/[Fn1] button (P25)	18	[MIC] socket
6	Function button (Fn11) (P25)	19	[REMOTE] socket
7	Rear dial (P21)	20	USB socket
8	Shutter button (P17)	21	[HDMI] socket
9	Front dial (P21)	22	Shoulder strap eyelet (P12)
10	Self-timer indicator/ AF Assist Lamp	23	Lens release button (P14)
11	Mode dial (P22)	24	Lens lock pin
12	Flash	25	Mount
13	Hot shoe (Hot shoe cover) • Keep the Hot Shoe Cover out of reach of children to prevent swallowing.	26	Sensor
		27	Lens fitting mark (P14)

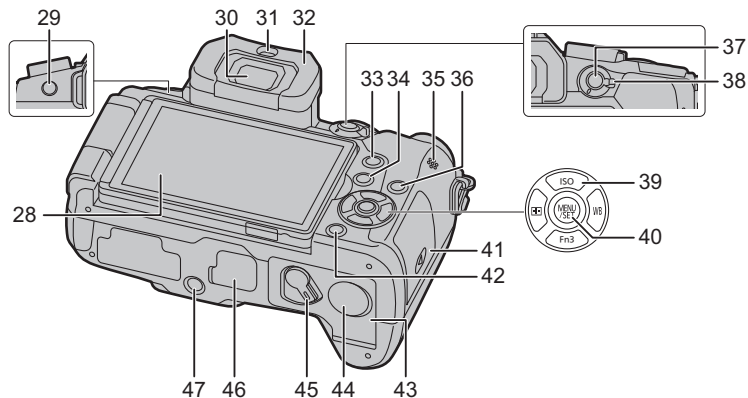

28 Touch screen (P23)/monitor (P58)	DC coupler cover (P72)
29 [LVF] button (P23)/[Fn5] button (P25)	<ul style="list-style-type: none"> • When using an AC adaptor, ensure that the Panasonic DC coupler (DMW-DCC8: optional) and AC adaptor (DMW-AC10PP: optional) are used.
30 Viewfinder (P23)	44 <ul style="list-style-type: none"> • Always use a genuine Panasonic AC adaptor (DMW-AC10PP: optional). • When using an AC adaptor, use the AC cable supplied with the AC adaptor.
31 Eye sensor (P23)	45 Release lever (P13)
32 Eyecup	46 Cover for the battery grip connector <ul style="list-style-type: none"> • Keep the cover for the battery grip connector out of reach of children to prevent swallowing.
33 [Q.MENU] button (P25)/[Fn2] button (P25)	47 Tripod mount <ul style="list-style-type: none"> • It may not be possible to attach and securely fasten a tripod with a screw length of 5.5 mm (0.22 inch) or more to the camera. Doing so may also damage the camera.
34 [▶] (Playback) button (P43)	
35 Speaker	
36 [DISP.] button <ul style="list-style-type: none"> • Each time this is pressed, the display on the monitor is switched. 	
37 [AF/AE LOCK] button	
38 Focus mode lever (P28)	
39 Cursor buttons (P21) <ul style="list-style-type: none"> ▲/[ISO] (ISO sensitivity) ▶/[WB] (White Balance) ◀/[] (Auto Focus Mode) ▼/[Fn3] (P25) 	
40 [MENU/SET] button (P24)	
41 Card door (P13)	
42 [/↵] (Delete/Cancel) button (P44)/[Fn4] button (P25)	
43 Battery door (P13)	

■ About the function button ([Fn6] to [Fn10])

- Function buttons ([Fn6] to [Fn10]) (P25) are touch icons. Touch the [] tab on the recording screen to display them.

■ Lens

H-FS12060

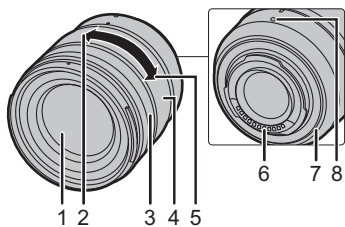

1	Lens surface
---	--------------

2	Tele
---	------

3	Focus ring (P28)
---	------------------

4	Zoom ring
---	-----------

5	Wide
---	------

6	Contact point
---	---------------

7	Lens mount rubber
---	-------------------

8	Lens fitting mark (P14)
---	-------------------------

■ Removing the Hot Shoe Cover

The camera comes with a hot shoe cover attached to the hot shoe.

Remove the hot shoe cover by pulling it in the direction indicated by arrow ② while pressing it in the direction indicated by arrow ①.

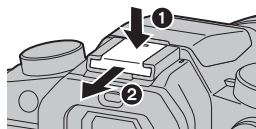

Basic Operations

Cursor buttons/[MENU/SET] button

Pressing the cursor button:

Selection of items or setting of values etc., is performed.

Pressing [MENU/SET]:

Confirmation of setting contents, etc., is performed.

- This owner's manual expresses the up, down, left, and right of the cursor button as ▲/▼/◀/▶.

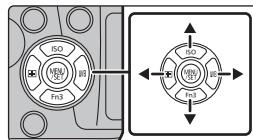

Front Dial/Rear Dial



Rotating:

Selection of items or setting of values is performed during the various settings.

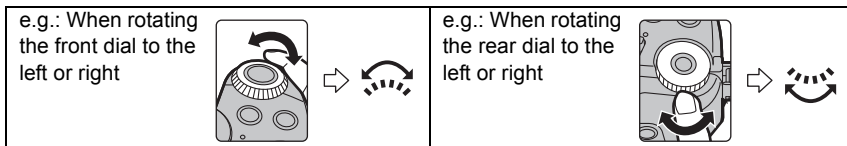
- This owner's manual describe operations of the front dial/rear dial as follows:



Allows you to set the aperture, shutter speed, and other settings when in **P / A / S / M** modes.





Mode dial	 Front dial	 Rear Dial
P	Program Shift	Program Shift
A	Aperture value	Aperture value
S	Shutter speed	Shutter speed
M	Aperture value	Shutter speed

Mode dial (Selecting a Recording Mode)

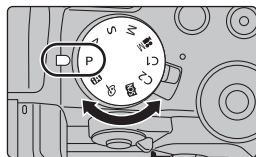
Select the mode by rotating the mode dial.

- Rotate the mode dial slowly to select the desired mode.



	Intelligent Auto Mode (P26)
	Intelligent Auto Plus Mode (P26)
P	Program AE Mode Records at the aperture value and shutter speed set by the camera.
A	Aperture-Priority AE Mode The shutter speed is automatically determined by the aperture value you set.
S	Shutter-Priority AE Mode The aperture value is automatically determined by the shutter speed you set.
M	Manual Exposure Mode The exposure is adjusted by the aperture value and the shutter speed which are manually adjusted.
	Creative Video Mode Records motion pictures with a manually set aperture value and shutter speed. <ol style="list-style-type: none"> 1 Press the motion picture button (or the shutter button) to start recording a motion picture. 2 Press the motion picture button (or the shutter button) to stop recording a motion picture. <ul style="list-style-type: none"> • You can adjust the aperture and shutter speed in the same way as you adjust them when the mode dial is set to P, A, S or M. The method for adjusting the aperture and shutter speed can be selected in [Exposure Mode] in the [Motion Picture] menu.
C1/C2	Custom Mode Use this mode to take pictures with previously registered settings.
	Scene Guide Mode This mode allows you to take pictures that match the scene being recorded.
	Creative Control Mode Record while checking the image effect.

[LVF] button (Switching the Monitor/Viewfinder)

Press [LVF] to switch between the Monitor and Viewfinder.

- Ⓐ [LVF] button
- Ⓑ Eye sensor

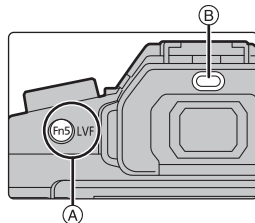

Press [LVF].

- The monitor/viewfinder will switch as follows:

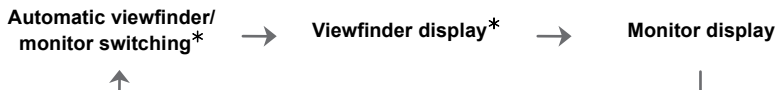

- * If [Eye Sensor AF] in the [Custom] menu is set to [ON], the camera automatically adjusts the focus as the eye sensor is activated. The camera does not beep when focus is achieved with [Eye Sensor AF].

■ Notes on automatic viewfinder/monitor switching

Automatic viewfinder/monitor switching enables the eye sensor to switch the display to the viewfinder automatically when you bring your eye or an object near it.

- If you enable the automatic viewfinder/monitor switching function and display the “On-monitor recording information screen” on the monitor, [Power Save LVF Shooting] in [Economy] can be used, allowing you to reduce the battery consumption.

Touch screen (Touch operations)

Touch screen of this unit is capacitive. Touch the panel directly with your bare finger.

■ Touch

To touch and release the touch screen.



■ Drag

A movement without releasing the touch screen.

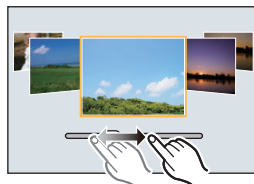

■ Pinch (enlarge/reduce)

Pinch the touch screen apart (enlarge) or together (reduce) with two fingers.



Setting menu items

1 Press [MENU/SET].

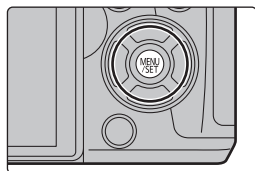

2 Press ▲/▼ of the cursor button to select the menu item and press [MENU/SET].

3 Press ▲/▼ of the cursor button to select the setting and press [MENU/SET].

- Depending on the menu item, its setting may not appear or it may be displayed in a different way.



■ Switching to other menus

1 Press ◀.

2 Press ▲/▼ to select a menu selector icon, such as [⚙].

- You can also select the menu toggle icons by rotating the front dial.

3 Press [MENU/SET].



■ Close the menu

Press [⏪/⏩] or press the shutter button halfway.

Calling frequently-used menus instantly

(Quick Menu)

By using the Quick Menu, some of the menu settings can be easily found.

- 1 Press [Q.MENU] to display the Quick Menu.
- 2 Rotate the front dial to select the menu item.
- 3 Rotate the rear dial to select the setting.
- 4 Press [Q.MENU] to exit the menu once the setting is complete.

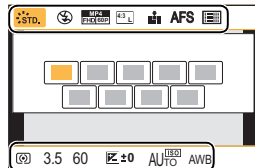

Assigning frequently used functions to the buttons (function buttons)

You can assign recording functions, etc. to specific buttons and icons.

- Some functions cannot be assigned depending on the function button.

- 1 Select the menu. (P24)

MENU → **fC [Custom]** → **[Fn Button Set]** → **[Setting in REC mode]/[Setting in PLAY mode]**

- 2 Press **▲/▼** to select the function button you want to assign a function to and then press **[MENU/SET]**.
- 3 Press **▲/▼** to select the function you want to assign and then press **[MENU/SET]**.

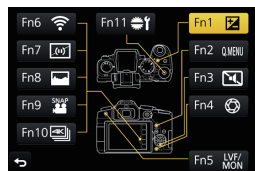

- If you press and hold a function button (any of [Fn1] to [Fn5] or [Fn11]) for 2 seconds, you can display the button assignment screen displayed in step 3, allowing you to assign the desired function quickly.

Taking Pictures using the Automatic Function

(Intelligent Auto Mode)

Recording Mode:  

In this mode, the camera makes the optimal settings for the subject and scene, so we recommend it when you wish to leave the settings to the camera and record without thinking about them.

1 Set the mode dial to .

- The camera will switch to either the most recently used of Intelligent Auto Mode or Intelligent Auto Plus Mode. At the time of purchase, the mode is set to Intelligent Auto Plus Mode.

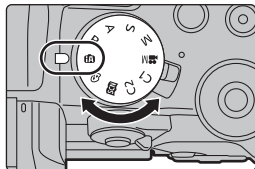





2 Align the screen with the subject.

- When the camera identifies the optimum scene, the icon of the scene concerned is displayed in blue for 2 seconds, after which its color changes to the usual red. (Automatic scene detection)



- When [iHandheld Night Shot] is set to [ON] and  is detected while taking handheld night shots, pictures of the night scenery will be taken at a high burst speed and composed into a single picture.
- When [iHDR] is set to [ON] and there is, for example, strong contrast between the background and the subject, multiple still pictures are recorded with differing exposures and combined to create a single still picture rich in gradation.

■ Switching between Intelligent Auto Plus Mode and Intelligent Auto Mode

Select the  or  tab on the menu screen, press ► to select  or , and press [MENU/SET].

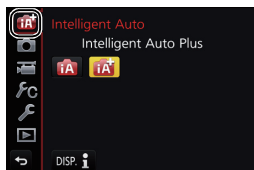

Taking a picture with a blurred background (Defocus Control)

Recording Mode: 

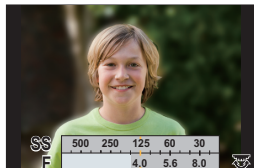

- 1 Press [Fn4] to display the setting screen.
- 2 Set the blurriness by rotating the rear dial.
 - If you press [MENU/SET], you can return to the recording screen.
 - Pressing [Fn4] on the blurriness setting screen will cancel the setting.



Recording images by changing the brightness or color tone

Recording Mode: 

■ Setting brightness

- 1 Press [].
- 2 Rotate the rear dial to adjust brightness.
 - Press [] again to return to the recording screen.

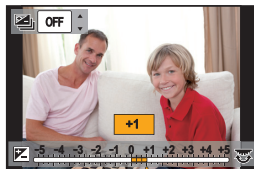

■ Setting color

- 1 Press  to display the setting screen.
- 2 Rotate the rear dial to adjust color.
 - Press [MENU/SET] to return to the recording screen.



Adjusting Focus Manually

Applicable modes: 

Use this function when you want to fix the focus or when the distance between the lens and the subject is determined and you do not want to activate Auto Focus.

When using an interchangeable lens (H-FS12060) with a focus ring

Rotate to **A side:**

Focuses on nearby subject

Rotate to **B side:**

Focuses on faraway subject

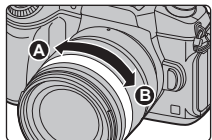

- 1** Set the focus mode lever to [MF].
- 2** Press ◀ ().
- 3** Press ▲/▼/◀/▶ to adjust the focus position, and press [MENU/SET].

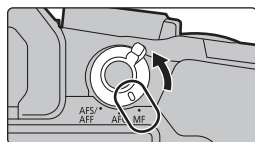

4 Adjust the focus.

(A) MF Assist (enlarged screen)



(B) Peaking

(C) MF Guide

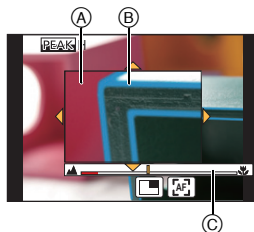
- The in-focus portions will be highlighted. (Peaking)
- You can check whether the point of focus is to the near side or to the far side. (MF Guide)



You can perform the following operations:

Button operation	Touch operation	Description of operation
▲/▼/◀/▶	Dragging	Moves the enlarged area
	Pinching out/in	Enlarges/reduces the screen in small steps.
	—	Enlarges/reduces the screen in large steps.
—		Switches the enlarged display (windowed/full screen)
[DISP.]	[Reset]	Resets the area to be enlarged back to the center.

5 Press the shutter button halfway.

- You can also perform the same operation by pressing [MENU/SET].





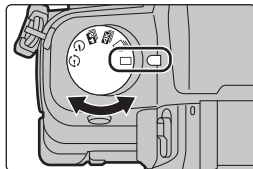

Select a Drive Mode

Applicable modes:   **P** **A** **S** **M**   

You can change what the camera will do when you press the shutter button.

Rotating the drive mode dial.



 [Single]	When the shutter button is pressed, only one picture is recorded.
 [Burst]	Recordings are made in succession while the shutter button is pressed.
 [4K PHOTO] (P30)	When the shutter button is pressed, a 4K photo is recorded.
 [Post Focus] (P32)	When the shutter button is pressed, Post Focus recording is performed.
 [Self Timer]	When the shutter button is pressed, recording takes place after the set time has elapsed.
 [Time Lapse/ Animation]	Pictures are recorded with Time Lapse Shot or Stop Motion Animation.

Recording 4K Photos

Applicable modes:

You can select the desired moment from a burst of pictures taken at 30 frames/second and save that moment as a picture of 8 million pixels (approx.).



- ① Record a 4K photo. ② Select and save pictures. ③ The picture is complete.

- Use a UHS Speed Class 3 card to record 4K photos. (P11)
- When recording 4K photos, the angle of view is narrower.

1 Set the drive mode dial to .

2 Select the menu. (P24)

MENU → [Rec] → [4K PHOTO] → [Rec Method]

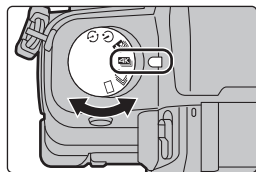

[4K Burst]*	<p>For capturing the best shot of a fast-moving subject</p> <p>Burst recording is performed while the shutter button is pressed and held.</p> <p>(A) Press and hold (B) Recording is performed</p>	
[4K Burst(S/S)]* "S/S" is an abbreviation of "Start/Stop".	<p>For capturing unpredictable photo opportunities</p> <p>Burst recording starts when the shutter button is pressed and stops when pressed again.</p> <p>(C) Start (First) (D) Stop (Second) (E) Recording is performed</p>	
[4K Pre-Burst]	<p>For recording as needed whenever a photo opportunity arises</p> <p>Burst recording is performed for approximately 1 second before and after the moment that the shutter button is pressed.</p> <p>(F) Approximately 1 second (G) Recording is performed</p>	

- * 4K burst file will be recorded and played back in separate files in the following cases. (You can continue recording without interruption.)
 - When using an SDHC memory card: If the file exceeds 4 GB
 - When using an SDXC memory card: If the continuous recording time exceeds 3 hours and 4 minutes or If the file exceeds 96 GB

3 Press the shutter button halfway to exit the menu.

4 Press the shutter button to perform recording.

- The camera will perform burst recording of a 4K photo and saves it as a 4K burst file in MP4 format.
 - When [Auto Review] is enabled, the picture selection screen will be displayed automatically.
- When [] ([4K Pre-Burst]) is set, the battery drains faster and the camera temperature rises. Select [] ([4K Pre-Burst]) only when recording.
- When the ambient temperature is high or 4K photo recording is performed continuously, the camera may display [] and recording may stop. (If [] ([4K Pre-Burst]) is selected, the setting changes to [] ([4K Burst]) before recording stops.) Wait until the camera cools down.



Selecting pictures from 4K burst file and saving

- The picture will be saved in JPEG format.

1 Select an image with the [] icon on the playback screen, and press ▲.

- If the image was recorded with [] ([4K Pre-Burst]), proceed to step 3.

2 Drag the slide bar to make a rough selection of scenes.

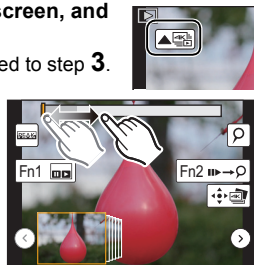

3 Drag the frames to select the frame you want to save as a picture.

4 Touch [] to save the picture.



Controlling Focus After Recording (Post Focus/Focus Stacking)

Applicable modes:   P A S M   

The camera can perform Burst recording in the same picture quality as 4K photo recording while automatically shifting the focus to different areas. After the recording, you can select the desired area on the screen and save a picture in which the selected area is in focus. You can also merge multiple pictures with different focus areas to widen the focus range. (Focus Stacking)

- We recommend that you use a tripod when recording images to be used for Focus Stacking.
- Use a UHS Speed Class 3 card. (P11)
- The angle of view becomes narrower when the Post Focus function is in use.

1 Set the drive mode dial to .

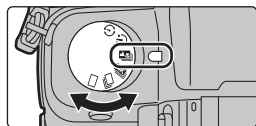

2 Decide on the composition, and press the shutter button halfway.

- Auto Focus will detect focus areas on the screen. (Excluding the edges of the screen)
- If no areas on the screen can be brought into focus, the focus display (A) will flash. Recording is not possible in this case.

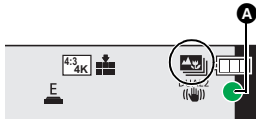

3 Press the shutter button fully to start recording.

- The focus point changes automatically while recording. When the icon (B) disappears, recording automatically ends.



From the time you press the shutter button halfway until the end of recording:









- Maintain the same distance to the subject and the same composition.
- Do not operate the zoom.
- A motion picture in MP4 format will be recorded. (Audio will not be recorded.)
- When [Auto Review] is enabled, a screen that lets you select the desired focus area will be displayed. (P33)
- If the surrounding temperature is high, recording is performed continuously with the Post Focus function, or the temperature of the camera rises,  may be displayed and recording may stop halfway through to protect the camera. Wait until the camera cools down.

Selecting the desired focus area and saving a picture

- 1 Select an image with the  icon on the playback screen, and press **▲**.
- 2 Touch the desired focus area.

- If a picture that is in focus is not available for the selected area, a red frame will be displayed. You cannot save a picture in this case.
- You cannot select the edges of the screen.



Button operation	Touch operation	Description of operation
	Touching	Selects a focus area. • It cannot be selected during enlarged display.
		Enlarges the display.
		Reduces the display (during enlarged display).
[Fn1]		Switches to the Focus Stacking function. (P33)
[Fn2]		In-focus portions are highlighted with color. ([Peaking])
[MENU/SET]		Saves the picture.

- 3 Touch  to save the picture.
 - The picture will be saved in JPEG format.

Merging multiple pictures to widen the focus range (Focus Stacking)

- 1 Touch  in step 2 of “Selecting the desired focus area and saving a picture”.
- 2 Touch the merging method.

[Auto Merging]	Automatically selects pictures that are suited to be merged, and merges them into a single picture. <ul style="list-style-type: none"> • Priority will be given to pictures with closer focus. • Pictures will be merged into a single picture and the resulting picture will be saved when this item is selected.
[Range Merging]	Merges pictures with specified focus areas into a single picture.

3 (When [Range Merging] is selected)

Touch the desired focus area.

- Specify at least two areas.
- In-focus areas between the two areas will also be selected, and the combined in-focus area will be indicated.
- Gray areas indicate areas that may, if selected, cause the merged picture to look unnatural and areas that cannot be selected.
- Touch the focus area again to cancel the selection.
- Dragging the screen allows you to select multiple areas.

Button operation	Touch operation	Description of operation
▲/▼/◀/▶	Touching	Selects an area.
[Fn2]	[Set/Cancel]	Specifies/cancels an area.
[DISP.]	[All]	Selects all areas. (Before selecting areas)
	[Reset]	Cancels all selections. (After selecting areas)
[MENU/SET]		Merges pictures and saves the resulting picture.

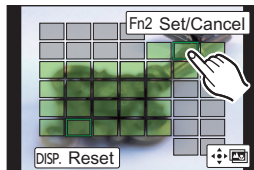
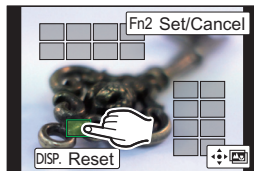

4 Touch to merge the pictures and save the resulting picture.

- The picture will be saved in JPEG format.
- The camera may automatically correct the misalignments of pictures caused by camera shake. If they are corrected, the angle of view becomes slightly narrower when pictures are merged.



Taking Pictures While Adjusting a Setting Automatically (Bracket Recording)

Applicable modes:       

You can take multiple pictures while automatically adjusting a setting by pressing the shutter button.

1 Select the menu. (P24)

MENU →  **[Rec]** → **[Bracket]** → **[Bracket Type]**

 (Exposure Bracket)	Press the shutter button to perform recording while adjusting the exposure.
 (Aperture Bracket)*	Press the shutter button to perform recording while adjusting the aperture.
FOCUS (Focus Bracket)	Press the shutter button to perform recording while adjusting the focus position.
 (White Balance Bracket)	Press the shutter button once to take three pictures with different white balance settings automatically.

* Available in Aperture-Priority AE Mode or when the ISO sensitivity is set to [AUTO] in Manual Exposure Mode.

2 Press ▲/▼ to select [More settings] and then press [MENU/SET].

- For information on [More settings], refer to the page that describes each function.
- When [**WB**] is selected, rotate the rear dial to the right (A-B axis) or left (G-M axis) to set the range of settings.
- Press the shutter button halfway to exit the menu.

3 Focus on the subject and take a picture.

■ To deactivate Bracket

Select [OFF] in step 1.

Exposure Bracket

■ About [More settings] (step 2 in P35)

[Step]	Sets the number of pictures to be taken and the exposure compensation range. [3•1/3] (Takes three pictures with an interval of 1/3 EV) to [7•1] (Takes seven pictures with an interval of 1 EV)
[Sequence]	Sets the order in which pictures are taken.
[Single Shot Setting]*	[□]: Takes one picture each time you press the shutter button. [📷]: Takes all the pictures set to be taken when you press the shutter button once.

- * Not available for burst recording. When using burst recording, if you press and hold the shutter button, recording will be performed continuously until a specified number of pictures are taken.

Aperture Bracket

Recording Mode: **A** **M**

■ About [More settings] (step 2 in P35)

[Image Count]	[3], [5]: Takes a specified number of pictures with different aperture values within the range based on the initial aperture value. [ALL]: Takes pictures using all aperture values.
---------------	---

- When using burst recording, if you press and hold the shutter button, recording will be performed until a specified number of pictures are taken.

The available aperture values vary depending on the lens.

Focus Bracket



■ About [More settings] (step 2 in P35)

[Step]	Sets the interval between focus positions.
[Image Count]*	Sets the number of pictures to be taken.
[Sequence]	[0/-/+]: Alternately moves the focus position closer and farther away within the range center on the initial position as you take pictures. [0/+]: Moves the focus position farther away from the initial position as you take pictures.

- * Not available for burst recording. When using burst recording, if you press and hold the shutter button, recording will be performed continuously until a specified number of pictures are taken.

















Image Stabilizer

The camera can activate either the In-Lens Image Stabilizer or In-Body Image Stabilizer, or it can activate both of them and reduce jitter even more effectively. (Dual I.S. Mode)

Dual I.S.2 (, , ), which provides more effective correction, is also supported.

For motion picture recording, you can use the 5-Axis Hybrid Image Stabilizer, which makes use of the In-Lens Image Stabilizer, In-Body Image Stabilizer, and Electronic Image Stabilizer.

- The image stabilizers to be activated differ depending on your lens. The icon for the currently activated image stabilizer is displayed on the recording screen.

	When taking pictures	When recording motion pictures
Panasonic lenses compatible with Dual I.S. Mode (Based on the Micro Four Thirds System standard) <ul style="list-style-type: none"> • For the latest information on compatible lenses, please refer to our website. • If the [DUAL2] or [DUAL] icon is not displayed on the recording screen even when a compatible lens is used, update the lens firmware to the latest version. (P9) 	Lens + Body (Dual I.S.) ( /  /  / )	Lens + Body (Dual I.S.) ( / ), 5-Axis Hybrid ( / )*
Lenses compatible with the image stabilizer function (Based on the Micro Four Thirds System standard/Four Thirds System standard)	Lens or Body ( / )	Lens or Body (), 5-Axis Hybrid ()*
Lenses not compatible with the image stabilizer function (Based on the Micro Four Thirds System standard/Four Thirds System standard)	Body ( / )	Body (), 5-Axis Hybrid ()*
When using a Leica lens mount adaptor (optional) or mount adaptor made by another manufacturer		

* When [E-Stabilization (Video)] is set to [ON]

Applicable modes: **P** **A** **S** **M**

- When using an interchangeable lens with O.I.S. switch, stabilizer function is activated if the O.I.S. switch of the lens is set to [ON]. () is set at the time of purchase)

Select the menu. (P24)

MENU → [Rec] → [Stabilizer]	
[Operation Mode]	([Normal]) Camera shake is corrected for up/down, left/right, and rotational movements.
	([Panning]) Camera shake is corrected for up/down movements. This mode is ideal for panning (a method of taking pictures which involves turning the camera to track the movements of a subject which continues to move in a fixed direction).
	[OFF] [Stabilizer] does not work. () • When using a lens with an O.I.S. switch, set the switch to [OFF].
[E-Stabilization (Video)]	Jitter during motion picture recording is corrected along the vertical, horizontal, roll, pitch, and yaw axes by making use of the In-Lens Image Stabilizer, In-Body Image Stabilizer, and Electronic Image Stabilizer. (5-Axis Hybrid Image Stabilizer) [ON]/[OFF] • When [ON] is selected, the angle of view of recorded motion pictures may become narrower.
[Focal Length Set]	If the focal length is not set automatically, you can set it manually. (P38) • When a manually selected focal length is set, a confirmation screen asking you to change the focal length setting is displayed after you turn on the camera. Selecting [Yes] allows you to set [Focal Length Set] in [Stabilizer].

Setting the focal length of a lens

1 Select the menu. (P24)

MENU → **[Rec]** → **[Stabilizer]** → **[Focal Length Set]**

2 Select the focal length of your lens with ◀▶.

- A focal length ranging from 8 mm to 1000 mm can be set.

3 Press [MENU/SET].



Recording Motion Picture/4K Motion Picture

Applicable modes:   P A S M   

This camera can record full high definition motion pictures compatible with the AVCHD format or motion pictures recorded in MP4.

In addition, the camera can record 4K motion pictures in MP4.

Audio will be recorded in stereo.

1 Start recording by pressing the motion picture button.

- (A) Elapsed recording time
- (B) Available recording time

- Recording of motion picture appropriate for each mode is possible.
- The recording state indicator (red) (C) will flash while recording motion pictures.
- Release the motion picture button right after you press it.

2 Stop the recording by pressing the motion picture button again.

- Still picture recording is also possible during the motion picture recording by fully pressing the shutter button. (Except for in Creative Video Mode)

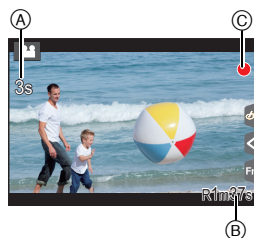
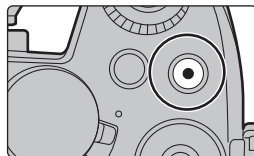

- When the ambient temperature is high or motion picture is recorded continuously, the camera may display  and stop the recording to protect itself. Wait until the camera cools down.
- AVCHD motion pictures:
You can continue recording without interruption even if the file size exceeds 4 GB, but the motion picture file will be divided.
- MP4 motion pictures with a [Rec Quality] size of [FHD] or [HD]:
You can continue recording without interruption even if the continuous recording time exceeds 30 minutes or the file size exceeds 4 GB, but the motion picture file will be divided and recorded/played back separately.
- MP4 motion pictures with a [Rec Quality] size of [4K]:
Motion picture file will be recorded and played back in separate files in the following cases. (You can continue recording without interruption.)
 - When using an SDHC memory card: If the file exceeds 4 GB
 - When using an SDXC memory card: If the continuous recording time exceeds 3 hours and 4 minutes or If the file exceeds 96 GB

■ Setting the format, size and recording frame rate

MENU →  **[Motion Picture]** → **[Rec Format]**

[AVCHD]	This data format is suitable for when playing back on a high-definition TV, etc.
[MP4]	This data format is suitable for when playing back on a PC, etc.

MENU →  **[Motion Picture]** → **[Rec Quality]**

When **[AVCHD]** is selected

Item	Size	Recording frame rate	Sensor output	Bit rate
[FHD/28M/60p] *1	1920×1080	60p	60 frames/second	28 Mbps
[FHD/17M/60i]	1920×1080	60i	60 frames/second	17 Mbps
[FHD/24M/30p]	1920×1080	60i	30 frames/second	24 Mbps
[FHD/24M/24p]	1920×1080	24p	24 frames/second	24 Mbps

*1 AVCHD Progressive

When **[MP4]** is selected

Item	Size	Recording frame rate	Sensor output	Bit rate
[4K/100M/30p] *2	3840×2160	30p	30 frames/second	100 Mbps
[4K/100M/24p] *2	3840×2160	24p	24 frames/second	100 Mbps
[FHD/28M/60p]	1920×1080	60p	60 frames/second	28 Mbps
[FHD/20M/30p]	1920×1080	30p	30 frames/second	20 Mbps
[HD/10M/30p]	1280×720	30p	30 frames/second	10 Mbps

*2 4K motion picture

- When recording motion pictures in 4K, use a card rated as UHS Speed Class 3. (P11)
- The angle of view of motion pictures in 4K is narrower than those of motion pictures in other sizes.
- To ensure highly accurate focus, 4K photos are recorded at reduced Auto Focus speeds. It may be difficult to focus on the subject with Auto Focus, but this is not a malfunction.

Recording Motion Pictures with 4K Live Cropping

Recording Mode: 

By cropping your motion picture down from the 4K angle of view to Full High Definition, you can record a motion picture that pans and zooms in/out while leaving the camera in a fixed position.

- Hold the camera firmly in place while recording.
- A motion picture will be recorded at [FHD/20M/30p] under [MP4].

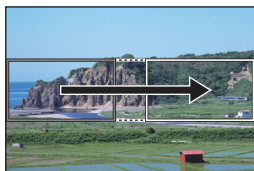

Pan

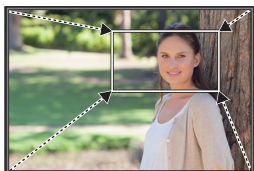

Zoom in

- When you want to zoom in/out, set different angles of view for the cropping start and end frames. For example, to zoom in, set a larger angle of view for the start frame and a smaller angle of view for the end frame.

1 Set mode dial to .

2 Select the menu. (P24)

MENU →  **[Motion Picture]** → **[4K Live Cropping]** → **[40SEC]/[20SEC]**

- The angle of view narrows.

3 Set the cropping start frame.

(A) Cropping start frame

- When making settings for the first time, a cropping start frame of size 1920×1080 is displayed. (After setting the cropping start frame and end frame, the start frame and end frame that you set immediately before will be displayed.)
- The camera will remember the frame position and size even when the camera is turned off.

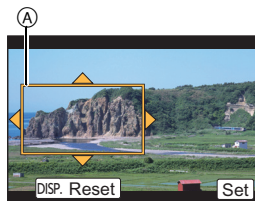

Button operation	Touch operation	Description of operation
▲/▼/◀/▶	Touching	Moves the frame.
	Pinching out/in	Enlarges/reduces the frame.
[DISP.]	[Reset]	Returns the position of the frame to the center and its size to the default setting.
[MENU/SET]	[Set]	Decides the position and size of the frame.

4 Repeat step 3, and then set the cropping end frame.

Ⓑ Cropping end frame

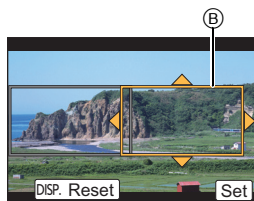

5 Press the motion picture button (or shutter button) to start recording.

- Immediately release the motion picture button (or the shutter button) after pressing it.
- When the set operating time has elapsed, recording automatically ends.
To end recording midway, press the motion picture button (or the shutter button) again.

■ Changing the position and size of a crop frame

Press [Fn4] while the recording screen is displayed, and perform steps 3 and 4.

■ To cancel [4K Live Cropping] recording

Set to [OFF] in step 2.

Playing Back Pictures

- 1 Press [▶].
- 2 Press ◀/▶.

- ◀: Play back the previous picture
- ▶: Play back the next picture

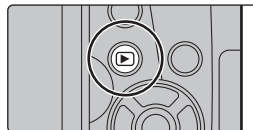

Sending an image to a web service

If you press ▼ when displaying images one by one, you can easily send an image to a web service.

- For details, refer to the “Owner’s Manual for advanced features (PDF format)”.

Playing Back Motion Pictures

This unit was designed to play motion pictures using the AVCHD and MP4 formats.



- Motion pictures are displayed with the motion picture icon (👤👤).

Press ▲ to play back.

- Ⓐ Motion picture recording time

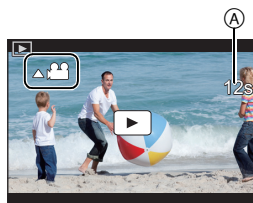
■ Operations during Motion Picture Playback



Button operation	Touch operation	Description of operation
▲	▶/	Play/Pause
▼	■	Stop
◀	◀◀	Fast rewind*1
	◀	Frame-by-frame rewind *2 (while pausing)
▶	▶▶	Fast forward*1
	▶	Frame-by-frame forward (while pausing)
	−	Reduce volume level
	+	Increase volume level

*1 The fast forward/rewind speed increases if you press ▶/◀ again.



*2 When a motion picture recorded with [AVCHD] is rewound frame-by-frame, its frames will be shown in intervals of approximately 0.5 seconds.

- If you press [MENU/SET] during a pause, you can create a picture from a motion picture.

Deleting Pictures

Once deleted, pictures cannot be recovered.

■ To delete a single picture

- 1 In Playback Mode, select the picture to delete and then press [].**
 - The same operation can be performed by touching [].

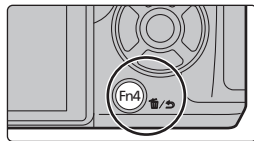

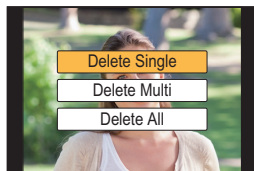

- 2 Press ▲ to select [Delete Single] and then press [MENU/SET].**



■ To delete multiple pictures (up to 100*) or all the pictures

- * Picture groups are treated as a single picture.
(All the pictures in the selected picture group will be deleted.)

- 1 In Playback Mode, press [].**
- 2 Press ▲/▼ to select [Delete Multi] or [Delete All] and then press [MENU/SET].**
 - It is possible to delete all pictures except the ones set as favorite when [All Delete Except Favorite] is selected with the [Delete All] set.
- 3 (When [Delete Multi] is selected) Press ▲/▼/◀/▶ to select the picture, and then press [MENU/SET] to set. (Repeat this step.)**
 - [] appears on the selected pictures.
If [MENU/SET] is pressed again, the setting is canceled.
- 4 (When [Delete Multi] is selected) Press ◀ to select [OK], and then press [MENU/SET] to execute.**

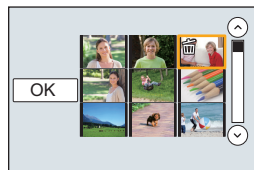

Menu list



To display explanations of the menu items.

When [Menu Information] in the [Setup] menu is set to [ON], explanations of the menu items and settings are displayed on the menu screen.

Ⓐ Explanations of the menu

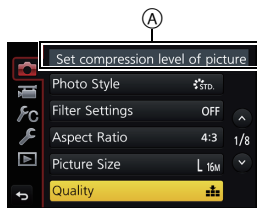

- [Photo Style], [Filter Settings], [AFS/AFF], [Metering Mode], [Highlight Shadow], [i.Dynamic], [i.Resolution], [Diffraction Compensation], [Digital Zoom] and [Stabilizer] are common to both the [Rec] menu and [Motion Picture] menu. Changing these settings in one of these menus is reflected in other menu.

[Rec]

This menu lets you set the aspect ratio, number of pixels, 4K Photo and other aspects of the pictures you are recording.

[Photo Style]	[Highlight Shadow]	[ISO Limit Set]
[Filter Settings]	[i.Dynamic]	[ISO Increments]
[Aspect Ratio]	[i.Resolution]	[Extended ISO]
[Picture Size]	[i.Handheld Night Shot]	[Long Shtr NR]
[Quality]	[iHDR]	[Shading Comp.]
[AFS/AFF]	[HDR]	[Diffraction Compensation]
[Metering Mode]	[Multi Exp.]	[Ex. Tele Conv.]
[Burst Rate]	[Panorama Settings]	[Digital Zoom]
[4K PHOTO]	[Shutter Type]	[Color Space]
[Bracket]	[Shutter Delay]	[Stabilizer]
[Self Timer]	[Flash]	[Face Recog.]
[Time Lapse/Animation]	[Red-Eye Removal]	[Profile Setup]

[Motion Picture]

This menu lets you set the [Rec Format], [Rec Quality], and other aspects for motion picture recording.

[Photo Style]	[Metering Mode]	[Silent Operation]
[Filter Settings]	[Highlight Shadow]	[Mic Level Disp.]
[4K Live Cropping]	[i.Dynamic]	[Mic Level Adj.]
[Snap Movie]	[i.Resolution]	[Special Mic.]
[Rec Format]	[Diffraction Compensation]	[Mic Level Limiter]
[Rec Quality]	[Luminance Level]	[Wind Noise Canceller]
[Exposure Mode]	[Ex. Tele Conv.]	[Wind Cut]
[AFS/AFF]	[Digital Zoom]	[Lens Noise Cut]
[Picture Mode]	[Stabilizer]	
[Continuous AF]	[Flkr Decrease]	

[Custom]

Operation of the unit, such as displaying of the screen and button operations, can be set up according to your preferences.

[Cust.Set Mem.]	[MF Assist]	[Rec Area]
[Silent Mode]	[MF Assist Display]	[Remaining Disp.]
[AF/AE Lock]	[MF Guide]	[Auto Review]
[AF/AE Lock Hold]	[Peaking]	[Fn Button Set]
[Shutter AF]	[Histogram]	[Lens Position Resume]
[Half Press Release]	[Guide Line]	[Q.MENU]
[Quick AF]	[Center Marker]	[Dial Set.]
[Eye Sensor AF]	[Highlight]	[Video Button]
[Pinpoint AF Time]	[Zebra Pattern]	[Power Zoom Lens]
[Pinpoint AF Display]	[Monochrome Live View]	[Eye Sensor]
[AF Assist Lamp]	[Constant Preview]	[Touch Settings]
[Direct Focus Area]	[Expo.Meter]	[Touch Scroll]
[Focus/Release Priority]	[LVF Disp.Style]	[Menu Guide]
[AF Sensitivity]	[Monitor Disp. Style]	[Shoot w/o Lens]
[AF+MF]	[Monitor Info. Disp.]	

[Setup]

This menu lets you perform the clock settings, select the operating beep tone settings and set other settings which make it easier for you to operate the camera.

You can also configure the settings of Wi-Fi related functions.

[Online Manual]	[Economy]	[No.Reset]
[Clock Set]	[Battery Use Priority]	[Reset]
[World Time]	[USB Mode]	[Reset Wi-Fi Settings]
[Travel Date]	[TV Connection]	[Pixel Refresh]
[Wi-Fi]	[Menu Resume]	[Sensor Cleaning]
[Beep]*	[Menu Background]	[Level Gauge Adjust.]
[Live View Mode]	[Menu Information]	[Demo Mode]
[Monitor Display]/ [Viewfinder]	[Language]	[Format]
[Monitor Luminance]	[Version Disp.]	
	[Exposure Comp. Reset]	

* This allows you to set the volume for electronic sound and the electronic shutter sound.

[Playback]

This menu lets you set the Protection, Cropping or Print Settings, etc. of recorded pictures.

[2D/3D Settings]	[Title Edit]	[Rotate Disp.]
[Slide Show]	[Text Stamp]	[Favorite]
[Playback Mode]	[Video Divide]	[Print Set]
[Location Logging]	[Time Lapse Video]	[Protect]
[RAW Processing]	[Stop Motion Video]	[Face Rec Edit]
[4K PHOTO Bulk Saving]	[Resize]	[Picture Sort]
[Light Composition]	[Cropping]	[Delete Confirmation]
[Clear Retouch]	[Rotate]	

[Aspect Ratio]

Applicable modes: **P** **A** **S** **M**

This allows you to select the aspect ratio of the pictures to suit printing or the playback method.

MENU → **[Rec]** → **[Aspect Ratio]**

[4:3]	[Aspect Ratio] of a 4:3 TV
[3:2]	[Aspect Ratio] of a 35 mm film camera
[16:9]	[Aspect Ratio] of a high-definition TV, etc.
[1:1]	Square aspect ratio

[Picture Size]

Applicable modes: **P** **A** **S** **M**

Set the number of pixels.

The higher the numbers of pixels, the finer the detail of the pictures will appear even when they are printed onto large sheets.

MENU → **[Rec]** → **[Picture Size]**

When the aspect ratio is [4:3].

Settings	Image size
[L] (16M)	4592×3448
[EXM] (8M)	3232×2424
[EXS] (4M)	2272×1704

When the aspect ratio is [16:9].

Settings	Image size
[L] (12M)	4592×2584
[EXM] (8M)	3840×2160
[EXS] (2M)	1920×1080

When the aspect ratio is [3:2].

Settings	Image size
[L] (14M)	4592×3064
[EXM] (7M)	3232×2160
[EXS] (3.5M)	2272×1520

When the aspect ratio is [1:1].







Settings	Image size
[L] (11.5M)	3424×3424
[EXM] (6M)	2416×2416
[EXS] (3M)	1712×1712



[Quality]

Applicable modes:   **P** **A** **S** **M**   

Set the compression rate at which the pictures are to be stored.

MENU →  **[Rec]** → **[Quality]**





Settings	File format	Description of settings
[]	JPEG	A JPEG image in which image quality was given priority.
[]		A standard image quality JPEG image. This is useful for increasing the number of shots without changing the number of pixels.
[RAW]	RAW+JPEG	You can record a RAW image and a JPEG image ([] or []) simultaneously.
[RAW]		
[RAW]	RAW	You can only record RAW images.

- RAW images are always recorded in the [4:3] (4592×3448) aspect ratio.
- When you delete an image recorded with **[RAW]** or **[RAW]**, both the RAW and JPEG images will be deleted simultaneously.
- When you play back an image recorded with **[RAW]**, gray areas corresponding to the aspect ratio at the time of recording are displayed.
- You can process RAW images in [RAW Processing] in the [Playback] menu. (P48)
- Use software (“SILKYPIX Developer Studio” (P57) by Ichikawa Soft Laboratory) to process and edit RAW files on a PC.

[RAW Processing]

You can process the pictures taken in RAW format. The processed pictures will be saved in JPEG format.

MENU →  **[Playback]** → **[RAW Processing]**

- 1 **Select RAW images with / , and then press [MENU/SET].**
- 2 **Press /  to select an item.**



[White Balance]

[Exposure Comp.]

[Photo Style]

[i.Dynamic]

[Contrast]

[Highlight]

[Shadow]

[Saturation]/[Color Tone]

[Filter Effect]

[Noise Reduction]

[i.Resolution]

[Sharpness]

[Setup]

- 3 Press [MENU/SET] and set.
- 4 Press [MENU/SET].
 - This operation returns you to the screen in step 2. To set other items, repeat steps 2 through 4.
- 5 Select [Begin Processing] with ▲/▼, and then press [MENU/SET].

■ How to set each item

Button operation	Touch operation	Description of operation
	Dragging	Selects a setting.
▲	[WB K Set]	Displays the screen that lets you set the color temperature. (only when [White Balance] is set to [K])
▼	[Adjust.]	Displays the screen that lets you fine-adjust the White Balance. (only when [White Balance] is set)
[DISP.]	[DISP.]	Displays the comparison screen.
[MENU/SET]	[Set]	Sets the adjusted level and returns you to the item selection screen.



- When [Noise Reduction], [i.Resolution] or [Sharpness] is selected, the comparison screen cannot be displayed.
- If you touch the picture twice, the picture will be enlarged. If you touch the picture twice when it is enlarged, it will be reduced to the original size.

On the comparison screen, you can use the following operations to make adjustments:

Ⓐ Current setting

Button operation	Touch operation	Description of operation
	Dragging	Selects a setting.
[DISP.]	[DISP.]	Returns you to the setting screen.
[MENU/SET]	[Set]	Sets the adjusted level and returns you to the item selection screen.

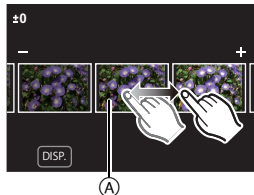

- If you touch the picture at the center, it will be enlarged. If you touch [Ⓛ], the picture will be reduced to the original size.

[Setup] setting

When you select an item, the screen that asks you to select [Reinstate Adjustments], [Color Space], or [Picture Size] will be displayed.

- 1 Press ▲/▼ to select an item, and press [MENU/SET].
 - If you select [Reinstate Adjustments], a confirmation screen will be displayed. Selecting [Yes] will execute the operation and return you to the item selection screen.
- 2 Press ▲/▼ to select a setting, and press [MENU/SET].

[Light Composition]

Select multiple frames that you wish to combine from 4K burst files. Parts of the image that are brighter than the preceding frame will be superimposed on the preceding frame to combine the frames into one picture.

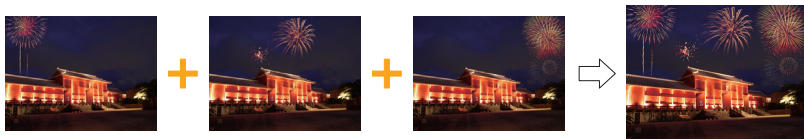

MENU →  **[Playback]** → **[Light Composition]**

- 1 Press ◀/▶ to select the 4K photo burst files and press [MENU/SET].
- 2 Choose the combining method, and then press [MENU/SET].

[Composite Merging] setting

Select the frames you want to combine to superimpose brighter parts.

- 1 Select the frames.



- 2 Press [MENU/SET].

The selected frames are remembered, and the display goes to the preview screen.

Press ▲/▼ to select items and press [MENU/SET] to perform the following operations.

- [Next]: Lets you select more frames for combining. Goes back to step 1.
- [Reselect]: Discards the frame selected immediately before and lets you select a different image.
- [Save]: Ends frame selection.



- 3 Repeat steps 1 and 2 to select more frames to combine.
 - You can select up to 40 frames.

- 4 Press ▼ to select [Save], and then press [MENU/SET].

[Range Merging] setting

Select the first and last frames to superimpose the brighter parts of the frames between them.

- 1 Select the frame of the first picture, and press [MENU/SET].
The selection method is the same as in step 1 of [Composite Merging] setting.
- 2 Select the frame of the last picture, and press [MENU/SET].

- 3 **Select [Yes] at the confirmation screen, and then press [MENU/SET].**

The combined picture is displayed.

- Pictures are saved in JPEG format.

What you can do with the Wi-Fi® function

- The camera cannot be used to connect to a public wireless LAN connection.

Controlling with a Smartphone/Tablet (P53)

- Recording with a smartphone (P55)
- Playing back images in the camera (P55)
- Saving images stored in the camera (P55)
- Sending images in the camera to an SNS (P55)
- Writing location information on images stored in the camera (P56)
- Combining motion pictures recorded with Snap Movie according to your preference on a smartphone

Displaying pictures on a TV

Printing Wirelessly

Sending images to AV device

Sending images to PC

Using Web services

This owner's manual refer to both smartphones and tablets as "smartphones" from this point on unless noted otherwise.

- For details, refer to the "Owner's Manual for advanced features (PDF format)".

■ About the Wi-Fi connection lamp

Lit blue: When the Wi-Fi function is ON or connected by Wi-Fi

Blinking blue: When sending picture data

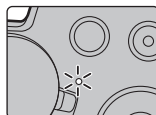

■ About the [Wi-Fi] button

In this owner's manual, a function button to which [Wi-Fi] is assigned is referred to as the [Wi-Fi] button.

(By default, [Wi-Fi] is assigned to [Fn6] when the camera is in Recording Mode, while it is assigned to [Fn1] when the camera is in Playback Mode.)

- For information about the function button, refer to P25.

Steps for pressing [Wi-Fi] (in Recording Mode)

- 1 Touch [Fn6].
- 2 Touch [Wi-Fi].



Controlling with a Smartphone/Tablet

Installing the smartphone/tablet app “Image App”

The “Panasonic Image App” (hereafter “Image App”) is an application provided by Panasonic.

• OS

App for Android™: Android 4.0 or higher

App for iOS: iOS 7.0 or higher

1 Connect the smartphone to a network.

2 (Android) Select “Google Play™ Store”.

(iOS) Select “App Store”.

3 Enter “Panasonic Image App” or “LUMIX” into the search box.

4 Select “Panasonic Image App”  and install it.

- Use the latest version.
- Supported OSs are current as of September 2016 and are subject to change.
- Read the [Help] in the “Image App” menu for further details on how to operate.
- When you operate the “Image App” on the smartphone that is connected to the camera via Wi-Fi, [Help] in the “Image App” may not be displayed depending on the smartphone. In this case, after terminating the connection to the camera, reconnect the smartphone to a mobile phone network such as the 3G or LTE network or to a Wi-Fi router, and then display [Help] in the “Image App”.
- Some of the screens and information provided in this owner’s manual may differ from your device depending on the supported OS and “Image App” version.
- The service may not be able to be used properly depending on the type of smartphone being used.

For information on the “Image App”, refer to the support site below.

<http://panasonic.jp/support/global/cs/dsc/>

(This Site is English only.)

- When downloading the app on a mobile network, high packet communication fees may be incurred depending on the details of your contract.

Connecting to a smartphone/tablet

Connecting without using the password

You can easily set up a direct connection to your smartphone without entering a password.

On the camera

Select the menu. (P24)

MENU →  **[Setup]** → **[Wi-Fi]** → **[Wi-Fi Function]** → **[New Connection]** → **[Remote Shooting & View]**

Ⓐ SSID

- When the camera is ready to be connected to the smartphone, the SSID is displayed.
- You can also display the information by pressing [Wi-Fi] on the camera.



On your smartphone

- 1 Turn on the Wi-Fi function in the setting menu.
- 2 On the Wi-Fi setting screen, select the SSID displayed on the camera.
- 3 Start “Image App”.
 - When the connection confirmation screen is displayed on the camera, select [Yes] to connect. (For first time connection only)



At the time of purchase, [Wi-Fi Password] is set to [OFF].

Before connecting to a Wi-Fi network, ensure that the device displayed on the connection confirmation screen is the one you actually want to connect to. When a wrong device is displayed, if you select [Yes], the camera will automatically connect to that device.

We recommend that you set [Wi-Fi Password] to [ON] if, for example, there is another Wi-Fi device nearby.

Terminating the connection

- 1 Set the camera to Recording Mode.
- 2 Select the camera's menu items to terminate the Wi-Fi connection.

MENU →  **[Setup]** → **[Wi-Fi]** → **[Wi-Fi Function]** → **[Yes]**

- You can also terminate the connection by pressing [Wi-Fi] on the camera.
- 3 On the smartphone, close “Image App”.
 - (If you are using an iOS device)
On the screen of “Image App”, press the home button to close the app.
 - (If you are using an Android device)
On the screen of “Image App”, press the return button twice to close the app.

Taking images via a smartphone/tablet (remote recording)

1 Connect to a smartphone. (P54)

2 Operate the smartphone.

- ① Select [].
- ② Record an image.
 - The recorded images are saved in the camera.
 - Some settings are not available.



Playing back images in the camera

1 Connect to a smartphone. (P54)

2 Operate the smartphone.

- ① Select [].
- ② Touch the image to enlarge it.



Saving images stored in the camera

1 Connect to a smartphone. (P54)

2 Operate the smartphone.

- ① Select [].
- ② Touch and hold an image, and drag it to save it.
 - Pictures in RAW format, AVCHD motion pictures, MP4 motion pictures with a [Rec Quality] size of [4K], 4K burst files, and images recorded with the Post Focus function cannot be saved.



Sending images in the camera to an SNS

1 Connect to a smartphone. (P54)

2 Operate the smartphone.

- ① Select [].
- ② Touch and hold an image, and drag it to send it to an SNS, etc.
 - The image is sent to a web service such as an SNS.



Adding location information to images stored in the camera from a smartphone/tablet

You can send location information acquired with a smartphone to the camera. **After sending the information, you can also write it on images stored in the camera.**

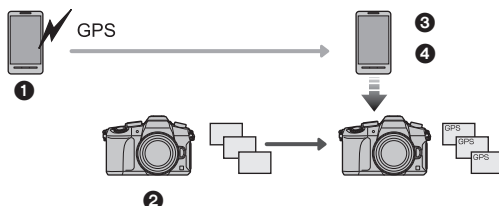

- ❶ Start recording location information
- ❷ Start recording images
- ❸ Finish recording the location information
- ❹ Sending and writing location information



■ Operate the smartphone

- 1 **Connect to a smartphone. (P54)**
- 2 **Select [].**
- 3 **Select [Geotagging].**
- 4 **Select an icon.**



	<p>Start/stop recording location information.</p> <ul style="list-style-type: none"> • The smartphone battery drains faster while location information is being recorded. When recording of location information is not necessary, stop it.
	<p>Sending and writing location information.</p> <ul style="list-style-type: none"> • Follow the on-screen messages to operate the smartphone. • Images with location information are indicated with [GPS].

Downloading software

Download and install software to edit and play back images with a PC.

- To download the software, you need to connect the PC to the Internet.
- It may take some time to download the software depending on the communication environment.

PHOTOfunSTUDIO 9.9 PE (Windows 7/Windows 8/Windows 8.1/Windows 10)

This software allows you to manage images. For example, you can send pictures and motion pictures to a PC and sort them by recording date or model name. You can also perform operations such as writing images to a DVD, processing and correcting images, and editing motion pictures.

Check the site below to download and install the software.

Download the software while it is available for download.

http://panasonic.jp/support/global/cs/soft/download/d_pfs99pe.html

(This Site is English only.)

- Download expiration: September 2021
- For details about information such as the operating environment or operating method, refer to the “Owner’s Manual for advanced features (PDF format)” or the operating instructions for the respective software programs.
- “PHOTOfunSTUDIO” is not compatible with Mac.

SILKYPIX Developer Studio SE (Windows 7/Windows 8/Windows 8.1/Windows 10, Mac OS X v10.6 to v10.11)

This is software to edit RAW format images.

Edited images can be saved in a format (JPEG, TIFF, etc.) that can be displayed on a personal computer.

Check the site below to download and install the software.

<http://www.isl.co.jp/SILKYPIX/english/p/>

- For details on how to use the SILKYPIX Developer Studio, refer to the “Help” or the Ichikawa Soft Laboratory’s support website.

LoiLoScope 30 day full trial version (Windows 7/Windows 8/Windows 8.1/Windows 10)

This software allows you to edit motion pictures with ease.

Check the site below to download and install the software.

<http://loilo.tv/product/20>

- Only the trial version will be installed.
- For more information on how to use LoiLoScope, read the LoiLoScope manual available for download at the site.
- “LoiLoScope” is not compatible with Mac.

Monitor Display/Viewfinder Display

- The following images are examples of when the display screen is set to [] (monitor style) in the monitor.



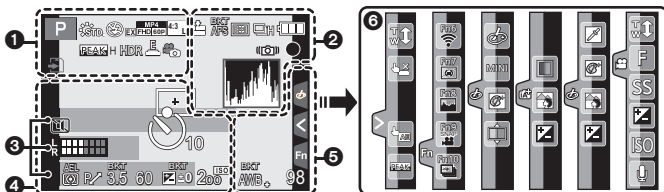













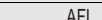
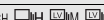

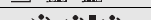

















In recording



1





















	Recording Mode (P22)
C 1	Custom settings
	Photo Style
	Flash Mode
	Flash
	Extended Tele Conversion (when recording motion pictures)
	Recording format/Recording quality (P40)
	Snap Movie
	Picture size/Aspect Ratio (P47)
	Extended Tele Conversion (when taking still pictures)
	Image size ([Panorama Shot])
	Image effect (filter) adjustment display
EXPS	Image effect (filter) setting

	Card (displayed only during recording)
8m30s	Elapsed recording time*1 (P39)
	Simultaneous recording indicator
	Automatic viewfinder/monitor switching (P23)
	Peaking
	Highlight Shadow
HDR	HDR/iHDR
	Multi exposure
	Digital Zoom
	Electronic shutter
	Picture Mode (Photo Priority)
	Overheat indicator (P63)

2	 RAW	Quality (P48)
	AFS AFF AFC MF	Focus Mode
	 BKT AFS	Focus Bracket (P36)
	 Post Focus	Post Focus (P32)
	 AF Mode	AF Mode
	 Pull Focus	Pull Focus
	 Face Recognition	Face Recognition
	AFL	AF Lock
	 SH H LV M L	Burst
	 4K Photo	4K Photo (P30)
	 10 10 2	Self-timer
	 Battery	Battery indication
	BG	Battery Grip
	 DUAL2 DUAL	Image Stabilizer (P37)
	 DUAL2 DUAL	Jitter alert
	 (([O]))	Jitter alert
	 ●	Recording state (Flashes red./ Focus (Lights green.) (P17)
	 LOW	Focus (Under low illumination)
	 STAR	Focus (Starlight AF)
	 Wi-Fi	Connected to Wi-Fi
	 Histogram	Histogram
3	Name*2	
	Number of days that have passed since the departure date*3	
	Age*2	
	Location*3	
	Current date and time/Travel destination setting*3.	
		Exposure meter
		Focal distance display
		Step zoom
4		AF area
	+	Spot metering target
	+	Center marker display
	 10 10 2	Self-timer
	 L R	Mic level display
	 LIMIT OFF	Mic Level Limiter (OFF)
		Silent Mode
		External Microphone
	AEL	AE Lock
		Metering Mode
	 P	Program Shift
	3.5	Aperture value (P17)
	 BKT 3.5	Aperture Bracket (P36)
	60	Shutter speed (P17)
		Exposure compensation value
	 BKT ±0	Exposure Bracket (P36)
		Brightness (P27)
		Manual Exposure Assistance
	200 ISO	ISO sensitivity
5	 BKT AWB +	White Balance Bracket
		White Balance Fine Adjustment
		White Balance
		Color (P27)
	98	Number of recordable pictures
	r20	Maximum number of pictures that can be taken continuously
	R8m30s	Available recording time*1

6

Touch tab

		Touch zoom
		Touch Shutter
		Touch AE
		Peaking
		Function button (P25)
		Color (P27)
		Defocus control function (P27)
		Brightness (P27)
		Type of defocus ([Miniature Effect])
		One point color
		Position of the light source
		Image effect (filter) adjustment
		Image effect ON/OFF
		Image effect (filter)
		Aperture value (P17)
		Shutter speed (P17)
		ISO sensitivity
		Microphone level adjustment

*1 h: hour, m: minute, s: second

*2 This is displayed for about 5 seconds when the camera is turned on if the [Profile Setup] setting is set.

*3 This is displayed for about 5 seconds when the camera is turned on, after setting the clock and after switching from Playback Mode to Recording Mode.

In recording

On-monitor recording information

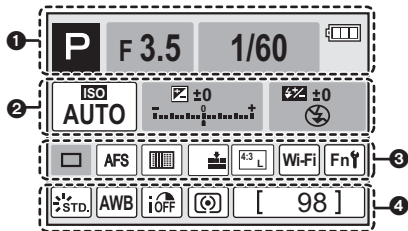

1

	Recording Mode (P22)
F3.5	Aperture value (P17)
1/60	Shutter speed (P17)
	Battery indication

2

 AUTO	ISO sensitivity
 ± 0 	Exposure compensation value Brightness (P27)
	Manual Exposure Assistance
	Flash Mode
 ± 0 	Flash

3

	Single
	Burst
	4K Photo (P30)
	Self-timer
AFS AFF AFC MF	Focus Mode
	AF Mode
	Quality (P48)
	Picture size/Aspect Ratio (P47)
Wi-Fi	Wi-Fi (P52)
Fn	Function button setting (P25)

4

	Photo Style
	White Balance
	Intelligent Dynamic Range Control
	Metering Mode
98	Number of recordable pictures
r20	Maximum number of pictures that can be taken continuously
R8m30s	Available recording time

Troubleshooting

First, try out the following procedures.

If the problem is not resolved, it may be improved by selecting [Reset] on the [Setup] menu.

- Please also refer to the “Owner’s Manual for advanced features (PDF format)”, which describes more detailed information.



When I shake the camera, I hear a rattling sound.

- The sound is caused by the In-Body Image Stabilizer. This is not a malfunction.

The camera cannot be operated even when it is turned on. The camera turns off immediately after it is turned on.

- The battery is exhausted.
→ Charge the battery. (P12)

The battery becomes flat too quickly.

- When [] ([4K Pre-Burst]) is selected, the battery drains faster.
→ Select [] ([4K Pre-Burst]) only when recording.

The subject is not focused properly.

- The subject is beyond the focus range of the camera.
- Is [Focus/Release Priority] in the [Custom] menu set to [RELEASE]?
- Is [Shutter AF] in the [Custom] menu set to [OFF]?
- Is the AF Lock applied incorrectly?

The recorded picture is blurred. The Image Stabilizer is not effective.

- The shutter speed will become slower and the Image Stabilizer function may not work properly when taking pictures especially in dark places.
→ We recommend using a tripod and the self-timer when taking pictures with a slow shutter speed.

The subject appears distorted on the picture.

- If you record a moving subject when using the electronic shutter or recording motion picture or a 4K photo, the subject may appear distorted on the picture. This is characteristic of MOS sensors which serve as the camera’s pickup sensors. This is not a malfunction.

Striping or flicker may appear under lighting such as fluorescent lighting and LED lighting fixture.

- This is characteristic of MOS sensors which serve as the camera's pickup sensors. This is not a malfunction.
- When using the electronic shutter, lowering the shutter speed may reduce the effect of the horizontal stripes.
- If noticeable flicker or striping is seen under lighting such as a fluorescent or LED lighting fixture when recording motion pictures, you can reduce the flicker or striping by setting up [Flkr Decrease] and fixing the shutter speed. It is possible to select a shutter speed from [1/50], [1/60], [1/100], or [1/120]. You can set the shutter speed manually in the Creative Video Mode. (P22)

The brightness or the hue of the recorded picture is different from the actual scene.

- When recording under fluorescent or LED lighting fixture, etc., increasing the shutter speed may introduce slight changes to brightness and color. These are a result of the characteristics of the light source and do not indicate a malfunction.
- When recording subjects in extremely bright locations or recording under fluorescent lighting, LED lighting fixture, mercury lamp, sodium lighting, etc., the colors and screen brightness may change or horizontal striping may appear on the screen.

4K photo recording stops before finishing.

- When the ambient temperature is high or 4K photo recording is performed continuously, the camera may display [△] and recording may stop. (If [4K Pre-Burst] is selected, the setting changes to [4K Burst] before recording stops.) Wait until the camera cools down.

Recording motion pictures is not possible.

- You may not be able to record for a short while after turning this unit on when using a large capacity card.

Motion picture recording stops in the middle.

- When the ambient temperature is high or motion picture is recorded continuously, the camera may display [△] and stop the recording to protect itself. Wait until the camera cools down.

Sometimes it is difficult to focus with Auto Focus when recording 4K motion pictures.

- This phenomenon occurs when the camera is trying to record with highly accurate focus at a reduced Auto Focus speed, and is not a malfunction.

The flash is not activated.

- When the electronic shutter is used, the flash is not activated.
- When [Silent Mode] is set to [ON], the flash is not activated.

The picture is not played back. There are no recorded pictures.

- Is the card inserted?
- Is this a folder or picture which was processed in the PC?
If it is, it cannot be played back by this unit.
→ It is recommended to use the software "PHOTOfunSTUDIO" (P57) to write pictures from PC to card.
- Has [Playback Mode] been set for playback?
→ Change to [Normal Play].

A Wi-Fi connection cannot be established. Radio waves get disconnected. Wireless access point is not displayed.

■ General tips for using a Wi-Fi connection

- Use within the communication range of the device to be connected.
- Is any device, such as microwave oven, cordless phone, etc., that uses 2.4 GHz frequency operated nearby?
→ Radio waves may get interrupted when used simultaneously. Use them sufficiently away from the device.
- When the battery indicator is flashing red, the connection with other equipment may not start or the connection may be disrupted.
(A message such as [Communication error] is displayed.)
- If you place the camera on a metal table or shelf, the radio waves may be adversely affected. In such cases, you may not be able to establish a connection. Move the camera away from the metal surface.

■ About a wireless access point

- Check if the wireless access point to connect is in operating state.
- Check the radio wave condition of the wireless access point.
→ Move this unit closer to the wireless access point.
→ Change the location and orientation of the wireless access point.
- It may not display even if the radio waves exist depending on the setting of the wireless access point.
→ Turn off and on the wireless access point.
→ Check the settings of the wireless access point.
→ When the network SSID of the wireless access point is set not to broadcast, the wireless access point may not be detected. Enter the network SSID to start the connection or enable the SSID broadcast of the wireless access point.

When I try to set up a Wi-Fi connection with a Windows 8 PC, my user name and password are not recognized, so I cannot connect to the PC.

- Some OS versions, including Windows 8, use two types of accounts: a local account and a Microsoft account.
→ Be sure to use the user name and password for the local account.

The PC is not recognized when I use a Wi-Fi connection. The camera cannot be connected to PC via Wi-Fi connection.

- The default workgroup name is set to "WORKGROUP". If you changed the workgroup name, the PC will not be recognized.
In [Change Workgroup Name] in [PC Connection] of the [Wi-Fi Setup] menu, change the workgroup name to that of the PC you are connecting to.
- Please confirm login name and password are correctly typed.
- When the system time of Mac computer or Windows PC connected to a camera differs severely from that of the camera, the camera cannot be connected to the computer or PC in some OSs.
→ Please confirm [Clock Set] and [World Time] of the camera matches with time, date and time zone in Windows PC or Mac computer. When both settings do not match severely, please match them.

**It takes time to transmit an image to the web service.
Transmission of the image fails midway. Some images cannot be transmitted.**

- Is the size of the image too large?
→ Reduce the image size at [Size], and then send.
→ Transmit after dividing the motion picture with [Video Divide].
- It may take longer time to transmit when distance to the wireless access point is far.
→ Transmit closer to the wireless access point.
- File format of the motion picture that can be sent differs depending on the destination.

There is a sound from lens unit.

- It is a sound of lens movement or aperture operation when this unit is turned on or off, and it is not a malfunction.
- The sound, which is caused by the automatic adjustment of the aperture, is heard when the brightness has changed due to, for example, zooming or the movement of the camera. This is not a malfunction.

The camera becomes warm.

- The surface of the camera and the reverse side of the monitor may become warm during use. This does not affect the performance or quality of the camera.

The clock is reset.

- If you do not use the camera for a long time, the clock may be reset.
→ [Please set the clock] message will be displayed; please reset the clock. (P15)

Specifications

Specifications are subject to change without notice.

Digital Camera Body (DMC-G85):

Information for your safety

Power Source:	DC 8.4 V (--- 8.4 V)
Power Consumption:	2.8 W (When recording with Monitor) [When the Interchangeable lens (H-FS12060) is used]
	2.3 W (When playing back with Monitor) [When the Interchangeable lens (H-FS12060) is used]

Camera effective pixels	16,000,000 pixels
Image sensor	4/3" Live MOS sensor, total pixel number 16,840,000 pixels, Primary color filter
Digital Zoom	2×/4×
Extended Tele Conversion	When taking still pictures: Max. 2× (When a picture size of [S] (4 M), aspect ratio of [4:3] is selected.) When recording motion pictures: 2.4×/3.6×
Focus	Auto Focus/Manual Focus, Face/Eye Detection/Tracking/49-area-focusing/Custom Multi/ 1-area-focusing/Pinpoint (Touch focus area selection possible)
Shutter type	Focal-plane shutter

Burst recording	
Burst speed	Mechanical shutter 9 pictures/second (High speed, AFS), 6 pictures/second (High speed, AFC), 6 pictures/second (Middle speed), 2 pictures/second (Low speed)
	Electronic shutter 40 pictures/second (Super high speed), 10 pictures/second (High speed, AFS), 6 pictures/second (High speed, AFC), 6 pictures/second (Middle speed), 2 pictures/second (Low speed)
Number of recordable pictures	When there are RAW files: 45 or higher pictures When there are no RAW files: 300 or higher pictures * When recording is performed under the test conditions specified by Panasonic
ISO sensitivity (Standard Output Sensitivity)	AUTO/ $\frac{1}{100}$ */200/400/800/1600/3200/6400/12800/25600 (1/3 EV step change possible) * Only available when [Extended ISO] is set.
Minimum Illumination	Approx. 9 lx (when i-Low light is used, the shutter speed is 1/30th of a second) [When the Interchangeable lens (H-FS12060) is used]
Shutter speed	Still picture: B (Bulb) (Max. approx. 120 seconds), 60 seconds to 1/4000th of a second (Mechanical shutter), 1 second to 1/16000th of a second (Electronic shutter) Motion picture: 1/25th of a second to 1/16000th of a second
Metering range	EV 0 to EV 18
White Balance	Auto White Balance/Daylight/Cloudy/Shade/Incandescent lights/Flash/White set1/White set2/White set3/White set4/White Balance K set
Exposure (AE)	Program AE (P)/Aperture-priority AE (A)/Shutter-priority AE (S)/Manual exposure (M)/AUTO Exposure Compensation (1/3 EV Step, -5 EV to +5 EV)

Light metering system, Light metering mode	1728-zone multi-pattern sensing system, Multiple/Center weighted/Spot
Monitor	3.0" TFT LCD (3:2) (Approx. 1,040,000 dots) (field of view ratio about 100%) Touch screen
Viewfinder	OLED Live Viewfinder (4:3) (Approx. 2,360,000 dots) (field of view ratio about 100%) [Magnification approx. 1.48×, 0.74× (35 mm film camera equivalent), with 50 mm lens at infinity; -1.0 m^{-1}] (with diopter adjustment -4 to $+4$ diopter)
Flash	Built-in pop up flash GN 9.0 equivalent (ISO200 · m) [GN 6.4 equivalent (ISO100 · m)] Flash range: Approx. 0.5 m (1.6 feet) to 7.3 m (24 feet) [When the Interchangeable lens (H-FS12060) is mounted, WIDE, [ISO AUTO] is set]
Flash Mode	AUTO, AUTO/Red-Eye Reduction, Forced ON, Forced ON/ Red-Eye Reduction, Slow Sync., Slow Sync./Red-Eye Reduction, Forced OFF
Flash synchronization speed	Equal to or smaller than 1/160th of a second
Microphone	Stereo
Speaker	Monaural
Recording media	SD Memory Card/SDHC Memory Card*/SDXC Memory Card* (* UHS-I/UHS-II UHS Speed Class 3)
Picture size	
Still picture	When the aspect ratio setting is [4:3] 4592×3448 pixels, 3232×2424 pixels, 2272×1704 pixels When the aspect ratio setting is [3:2] 4592×3064 pixels, 3232×2160 pixels, 2272×1520 pixels When the aspect ratio setting is [16:9] 4592×2584 pixels, 3840×2160 pixels, 1920×1080 pixels When the aspect ratio setting is [1:1] 3424×3424 pixels, 2416×2416 pixels, 1712×1712 pixels

Recording quality		
Motion pictures	[AVCHD] 1920×1080 (FHD/60p: 28 Mbps), 60p recording/ 1920×1080 (FHD/60i: 17 Mbps), 60i recording/ 1920×1080 (FHD/30p: 24 Mbps), 60i recording*/ 1920×1080 (FHD/24p: 24 Mbps), 24p recording * Sensor output is 30 frames/sec. [MP4] 3840×2160 (4K/30p: 100 Mbps)/ 3840×2160 (4K/24p: 100 Mbps)/ 1920×1080 (FHD/60p: 28 Mbps)/ 1920×1080 (FHD/30p: 20 Mbps)/ 1280×720 (HD/30p: 10 Mbps)	
Quality	RAW/RAW+Fine/RAW+Standard/Fine/Standard/MPO+Fine/ MPO+Standard	
Recording file format		
Still Picture	RAW/JPEG (based on "Design rule for Camera File system", based on "Exif 2.3" standard, DPOF corresponding)/MPO	
Motion pictures	AVCHD Progressive/AVCHD/MP4	
Audio compression	AVCHD	Dolby® Digital (2 ch)
	MP4	AAC (2 ch)
Interface		
Digital	"USB 2.0" (High Speed)	
Terminal		
[REMOTE]	∅ 2.5 mm jack	
USB	USB 2.0 Micro-B	
[HDMI]	micro HDMI Type D	
[MIC]	∅ 3.5 mm jack	

Dimensions	Approx. 128.4 mm (W)×89 mm (H)×74.3 mm (D) [5.06" (W)×3.50" (H)×2.93" (D)] (excluding the projecting parts)
Mass (Weight)	Approx. 505 g/1.11 lb [with the card and battery] Approx. 453 g/1.00 lb (camera body) Approx. 715 g/1.58 lb [with the Interchangeable lens (H-FS12060), card and battery]
Operating temperature	0 °C to 40 °C (32 °F to 104 °F)
Operating humidity	10%RH to 80%RH
Dust-proof and splash-proof	Yes
Language select	[ENGLISH]/[DEUTSCH]/[FRANÇAIS]/[ESPAÑOL]/ [PORTUGUÊS]/[ITALIANO]/[繁體中文]/[日本語]

Wireless transmitter

Compliance standard	IEEE 802.11b/g/n (standard wireless LAN protocol)
Frequency range used (central frequency)	2412 MHz to 2462 MHz (1 to 11ch)
Encryption method	Wi-Fi compliant WPA™/WPA2™
Access method	Infrastructure mode

Battery Charger (Panasonic DE-A79B):

Information for your safety

Input:	~ 110 V–240 V 50/60 Hz 0.2 A
Output:	=== 8.4 V 0.65 A

Equipment mobility:

Movable

Battery Pack (lithium-ion) (Panasonic DMW-BLC12PP):

Information for your safety

Voltage/capacity:	7.2 V/1200 mAh
--------------------------	----------------

The symbols on this product (including the accessories) represent the following:

~	AC
===	DC
□	Class II equipment (The construction of the product is double-insulated.)

Interchangeable Lens	H-FS12060 “LUMIX G VARIO 12–60 mm/F3.5–5.6 ASPH./POWER O.I.S.”
Focal length	f=12 mm to 60 mm (35 mm film camera equivalent: 24 mm to 120 mm)
Aperture type	7 diaphragm blades/circular aperture diaphragm
Maximum aperture	F3.5 (Wide) to F5.6 (Tele)
Minimum aperture value	F22
Lens construction	11 elements in 9 groups (3 aspherical lenses, 1 ED lens)
In focus distance	Wide: 0.2 m (0.66 feet) to ∞ / Tele: 0.25 m (0.82 feet) to ∞ (from the focus distance reference line)
Maximum image magnification	0.27× (35 mm film camera equivalent: 0.54×)
Optical Image Stabilizer	Available
O.I.S. switch	None (Setting of the [Stabilizer] is done in [Rec] menu.)
Mount	“Micro Four Thirds Mount”
Angle of view	84° (Wide) to 20° (Tele)
Filter diameter	58 mm
Max. diameter	Approx. 66 mm (2.6 inch)
Overall length	Approx. 71 mm (2.8 inch) (from the tip of the lens to the base side of the lens mount)
Mass	Approx. 210 g/0.46 lb
Dust-proof and splash-proof	Yes

Digital Camera Accessory System

Description	Accessory#
Battery Pack	DMW-BLC12
AC Adaptor* ¹	DMW-AC10
DC Coupler* ¹	DMW-DCC8
LED Video Light	VW-LED1
Flash	DMW-FL200L, DMW-FL360L, DMW-FL580L
Stereo Shotgun Microphone	DMW-MS2
Stereo Microphone	VW-VMS10
Shutter Remote Control	DMW-RSL1
Battery Grip* ²	DMW-BGG1
Body Cap	DMW-BDC1
Tripod Adaptor* ³	DMW-TA1
Mount Adaptor	DMW-MA1, DMW-MA2M, DMW-MA3R

*1 The AC Adaptor (optional) can only be used with the designated Panasonic DC Coupler (optional). The AC adaptor (optional) cannot be used by itself.

*2 Supplied with a battery pack (DMW-BLC12).

*3 Use if the attached lens is in contact with the tripod pedestal.

Product numbers correct as of September 2016. These may be subject to change.

- Some optional accessories may not be available in some countries.
- NOTE: Accessories and/or model numbers may vary between countries. Consult your local dealer.
- For lens-related optional accessories such as compatible lenses and filters, refer to catalogs/ Web pages, etc.
- (For U.S.A. only)

To order optional accessories please visit <http://shop.panasonic.com> or your local Photo Specialty Dealer.

Reading the Owner's Manual (PDF format)

More detailed owner's manual is available in "Owner's Manual for advanced features (PDF format)". To read it, download it from the website.

<http://panasonic.jp/support/dsc/oi/index.html?model=DMC-G85&dest=P>



- Click the desired language.

■ To check the URL and QR code on the camera

Select the menu. (P24)

MENU →  [Setup] → [Online Manual]	
[URL display]	Displays the URL of the website on the camera's monitor.
[QR Code display]	Displays the QR code on the camera's monitor.

- You will need Adobe Reader to browse or print the "Owner's Manual for advanced features (PDF format)".

You can download and install a version of Adobe Reader that you can use with your OS from the following website. (As of September 2016)

<http://www.adobe.com/products/acrobat/readstep2.html>

Limited Warranty (ONLY FOR U.S.A.)

Panasonic Products Limited Warranty

Limited Warranty Coverage (For USA Only)

If your product does not work properly because of a defect in materials or workmanship, Panasonic Corporation of North America (referred to as "the warrantor") will, for the length of the period indicated on the chart below, which starts with the date of original purchase ("warranty period"), at its option either (a) repair your product with new or refurbished parts, (b) replace it with a new or a refurbished equivalent value product, or (c) refund your purchase price. The decision to repair, replace or refund will be made by the warrantor.

Product or Part Name	Parts	Labor
Digital Camera	1 Year	1 Year
All included Accessories (Except Non-Rechargeable Batteries)	90 Days	Not Applicable
Only Non-Rechargeable Batteries	10 Days	Not Applicable

During the "Labor" warranty period there will be no charge for labor. During the "Parts" warranty period, there will be no charge for parts. This Limited Warranty excludes both parts and labor for non-rechargeable batteries, antennas, and cosmetic parts (cabinet). This warranty only applies to products purchased and serviced in the United States. This warranty is extended only to the original purchaser of a new product which was not sold "as is".

Mail-In Service--Online Repair Request

Online Repair Request

To submit a new repair request and for quick repair status visit our Web Site at <http://shop.panasonic.com/support>.

When shipping the unit, carefully pack, include all supplied accessories listed in the Owner's Manual, and send it prepaid, adequately insured and packed well in a carton box. When shipping Lithium Ion batteries please visit our Web Site at <http://shop.panasonic.com/support> as Panasonic is committed to providing the most up to date information. Include a letter detailing the complaint, a return address and provide a daytime phone number where you can be reached. A valid registered receipt is required under the Limited Warranty.

IF REPAIR IS NEEDED DURING THE WARRANTY PERIOD, THE PURCHASER WILL BE REQUIRED TO FURNISH A SALES RECEIPT/PROOF OF PURCHASE INDICATING DATE OF PURCHASE, AMOUNT PAID AND PLACE OF PURCHASE. CUSTOMER WILL BE CHARGED FOR THE REPAIR OF ANY UNIT RECEIVED WITHOUT SUCH PROOF OF PURCHASE.

Limited Warranty Limits and Exclusions

This warranty ONLY COVERS failures due to defects in materials or workmanship, and DOES NOT COVER normal wear and tear or cosmetic damage. The warranty ALSO DOES NOT COVER damages which occurred in shipment, or failures which are caused by products not supplied by the warrantor, or failures which result from accidents, misuse, abuse, neglect, mishandling, misapplication, alteration, faulty installation, set-up adjustments, misadjustment of consumer controls, improper maintenance, power line surge, lightning damage, modification, introduction of sand, humidity or liquids, commercial use such as hotel, office, restaurant, or other business or rental use of the product, or service by anyone other than a Factory Service Center or other Authorized Servicer, or damage that is attributable to acts of God.

THERE ARE NO EXPRESS WARRANTIES EXCEPT AS LISTED UNDER “LIMITED WARRANTY COVERAGE”.

THE WARRANTOR IS NOT LIABLE FOR INCIDENTAL OR CONSEQUENTIAL DAMAGES RESULTING FROM THE USE OF THIS PRODUCT, OR ARISING OUT OF ANY BREACH OF THIS WARRANTY.

(As examples, this excludes damages for lost time, travel to and from the servicer, loss of or damage to media or images, data or other memory or recorded content. The items listed are not exclusive, but for illustration only.)

ALL EXPRESS AND IMPLIED WARRANTIES, INCLUDING THE WARRANTY OF MERCHANTABILITY, ARE LIMITED TO THE PERIOD OF THE LIMITED WARRANTY.

Some states do not allow the exclusion or limitation of incidental or consequential damages, or limitations on how long an implied warranty lasts, so the exclusions may not apply to you. This warranty gives you specific legal rights and you may also have other rights which vary from state to state. If a problem with this product develops during or after the warranty period, you may contact your dealer or Service Center. If the problem is not handled to your satisfaction, then write to:

Consumer Affairs Department
Panasonic Corporation of North America
661 Independence Pkwy
Chesapeake, VA 23320

PARTS AND SERVICE, WHICH ARE NOT COVERED BY THIS LIMITED WARRANTY, ARE YOUR RESPONSIBILITY.

Shop Accessories!

for all your Panasonic gear

Go to

<http://shop.panasonic.com/support>

Get everything you need to get the most out of your Panasonic products
Accessories & Parts for your Camera, Phone, A/V products, TV, Computers & Networking, Personal Care, Home Appliances, Headphones, Batteries, Backup Chargers & more...

Customer Services Directory

For Product Information, Operating Assistance, Parts, Owner's Manuals, Dealer and Service info
go to <http://shop.panasonic.com/support>

For the hearing or speech impaired TTY: 1- 877-833-8855

As of July 2015

Limited Warranty (ONLY FOR CANADA)

Panasonic Canada Inc.

5770 Ambler Drive, Mississauga, Ontario L4W 2T3

PANASONIC PRODUCT – LIMITED WARRANTY

Panasonic Canada Inc. warrants this product to be free from defects in material and workmanship under normal use and for a period as stated below from the date of original purchase agrees to, at its option either (a) repair your product with new or refurbished parts, (b) replace it with a new or a refurbished equivalent value product, or (c) refund your purchase price. The decision to repair, replace or refund will be made by Panasonic Canada Inc.

Digital Camera	One (1) year, parts and labour
Digital Camera Peripherals	One (1) year, parts and labour
Digital Camera Accessories	Ninety (90) days, parts and labour

This warranty is given only to the original purchaser, or the person for whom it was purchased as a gift, of a Panasonic brand product mentioned above sold by an authorized Panasonic dealer in Canada and purchased and used in Canada, which product was not sold "as is", and which product was delivered to you in new condition in the original packaging.

IN ORDER TO BE ELIGIBLE TO RECEIVE WARRANTY SERVICE HEREUNDER, A PURCHASE RECEIPT OR OTHER PROOF OF DATE OF ORIGINAL PURCHASE, SHOWING AMOUNT PAID AND PLACE OF PURCHASE IS REQUIRED

LIMITATIONS AND EXCLUSIONS

This warranty ONLY COVERS failures due to defects in materials or workmanship, and DOES NOT COVER normal wear and tear or cosmetic damage. The warranty ALSO DOES NOT COVER damages which occurred in shipment, or failures which are caused by products not supplied by Panasonic Canada Inc., or failures which result from accidents, misuse, abuse, neglect, mishandling, misapplication, alteration, faulty installation, set-up adjustments, misadjustment of consumer controls, improper maintenance, improper batteries, power line surge, lightning damage, modification, introduction of sand, humidity or liquids, commercial use such as hotel, office, restaurant, or other business or rental use of the product, or service by anyone other than a Authorized Servicer, or damage that is attributable to acts of God.

Dry cell batteries, printer ink cartridge and paper are also excluded from coverage under this warranty.

Rechargeable batteries are warranted for ninety (90) days from date of original purchase.

THIS EXPRESS, LIMITED WARRANTY IS IN LIEU OF ALL OTHER WARRANTIES, EXPRESS OR IMPLIED, INCLUDING ANY IMPLIED WARRANTIES OF MERCHANTABILITY AND FITNESS FOR A PARTICULAR PURPOSE. IN NO EVENT WILL PANASONIC CANADA INC. BE LIABLE FOR ANY SPECIAL, INDIRECT OR CONSEQUENTIAL DAMAGES RESULTING FROM THE USE OF THIS PRODUCT OR ARISING OUT OF ANY BREACH OF ANY EXPRESS OR IMPLIED WARRANTY. (As examples, this warranty excludes damages for lost time, travel to and from the Authorized Servicer, loss of or damage to media or images, data or other memory or recorded content. This list of items is not exhaustive, but for illustration only.)

In certain instances, some jurisdictions do not allow the exclusion or limitation of incidental or consequential damages, or the exclusion of implied warranties, so the above limitations and exclusions may not be applicable. This warranty gives you specific legal rights and you may have other rights which vary depending on your province or territory.

WARRANTY SERVICE

For product operation, repairs and information assistance, please visit our Support page:

www.panasonic.ca/english/support

This product incorporates the following software:

- (1) the software developed independently by or for Panasonic Corporation,
- (2) the software owned by third party and licensed to Panasonic Corporation, and/or
- (3) open source software

The software categorized as (3) is distributed in the hope that it will be useful, but WITHOUT ANY WARRANTY, without even the implied warranty of MERCHANTABILITY or FITNESS FOR A PARTICULAR PURPOSE.

Please refer to the detailed terms and conditions thereof displayed by selecting [MENU/SET] → [Setup] → [Version Disp.] → [Software info].

- G MICRO SYSTEM is a lens exchange type digital camera system of LUMIX based on a Micro Four Thirds System standard.
- Micro Four Thirds™ and Micro Four Thirds Logo marks are trademarks or registered trademarks of Olympus Imaging Corporation, in Japan, the United States, the European Union and other countries.
- Four Thirds™ and Four Thirds Logo marks are trademarks or registered trademarks of Olympus Imaging Corporation, in Japan, the United States, the European Union and other countries.
- SDXC Logo is a trademark of SD-3C, LLC.
- "AVCHD", "AVCHD Progressive" and the "AVCHD Progressive" logo are trademarks of Panasonic Corporation and Sony Corporation.
- Manufactured under license from Dolby Laboratories. Dolby and the double-D symbol are trademarks of Dolby Laboratories.
- The terms HDMI and HDMI High-Definition Multimedia Interface, and the HDMI Logo are trademarks or registered trademarks of HDMI Licensing, LLC in the United States and other countries.
- HDAVI Control™ is a trademark of Panasonic Corporation.
- Adobe is a trademark or registered trademark of Adobe Systems Incorporated in the United States and/or other countries.
- Pentium is a trademark of Intel Corporation in the U.S. and/or other countries.
- iMovie, Mac and Mac OS are trademarks of Apple Inc., registered in the U.S. and other countries.
- iPad, iPhone, iPod, and iPod touch are trademarks of Apple Inc., registered in the U.S. and other countries.
- App Store is a service mark of Apple Inc.
- Windows is a registered trademark or trademark of Microsoft Corporation in the United States and/or other countries.



- Android and Google Play are trademarks or registered trademarks of Google Inc.
- The Wi-Fi CERTIFIED™ Logo is a certification mark of Wi-Fi Alliance®.
- The Wi-Fi Protected Setup™ Identifier mark is a certification mark of Wi-Fi Alliance®.
- “Wi-Fi®” and “Wi-Fi Direct®” are registered trademarks of Wi-Fi Alliance®.
- “Wi-Fi Protected Setup™”, “WPA™”, and “WPA2™” are trademarks of Wi-Fi Alliance®.
- DLNA, the DLNA Logo and DLNA CERTIFIED are trademarks, service marks, or certification marks of the Digital Living Network Alliance.
- This product uses “DynaFont” from DynaComware Corporation. DynaFont is a registered trademark of DynaComware Taiwan Inc.
- QR Code is a registered trademark of DENSO WAVE INCORPORATED.
- Other names of systems and products mentioned in these instructions are usually the registered trademarks or trademarks of the manufacturers who developed the system or product concerned.



This product is licensed under the AVC Patent Portfolio License for the personal use of a consumer or other uses in which it does not receive remuneration to (i) encode video in compliance with the AVC Standard (“AVC Video”) and/or (ii) decode AVC Video that was encoded by a consumer engaged in a personal activity and/or was obtained from a video provider licensed to provide AVC Video. No license is granted or shall be implied for any other use. Additional information may be obtained from MPEG LA, L.L.C.

See <http://www.mpegla.com>

Panasonic Corporation of North America
Two Riverfront Plaza, Newark, NJ 07102-5490
<http://shop.panasonic.com>

Panasonic Canada Inc.
5770 Ambler Drive, Mississauga, Ontario L4W 2T3
www.panasonic.com

© Panasonic Corporation 2016

Printed in China